

SPECIFICATIONS

DIAMETER:	18" (0.71 MM)
SENSITIVITY (2.83 V @ 1 M):	95 dB
POWER HANDLING:	600 W _{RMS}
FREQUENCY RESPONSE:	20 ~ 300 Hz
NOMINAL IMPEDANCE:	4 OHMS
VOICE-COIL DIAMETER:	4.0" (102 MM)
DIMENSIONS:	

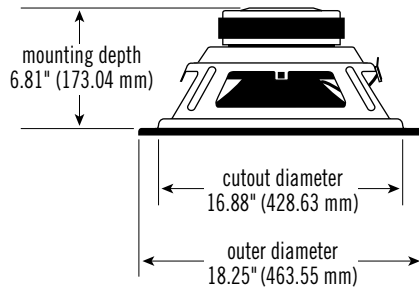

THIELE-SMALL PARAMETERS

VOICE COIL DC RESISTANCE:	R_{EVC} (OHMS)	2.50
VOICE COIL INDUCTANCE @ 1 KHZ:	L_{EVC} (MH)	0.98
DRIVER RADIATING AREA:	S_D (IN ²)	195.99
	S_D (CM ²)	1270.00
MOTOR FORCE FACTOR:	BL (TM)	13.51
COMPLIANCE VOLUME:	V_{AS} (FT ³)	15.37
	V_{AS} (LITERS)	362.61
SUSPENSION COMPLIANCE:	C_{MS} (µM/N)	158.32
MOVING MASS, AIR LOAD:	M_{MS} (GRAMS)	177.77
MOVING MASS, DIAPHRAGM:	M_{MD} (GRAMS)	151.75
FREE-AIR RESONANCE:	F_S (HZ)	30.00
MECHANICAL Q:	Q_{MS}	6.77
ELECTRICAL Q:	Q_{ES}	0.46
TOTAL Q:	Q_{TS}	0.43
MAGNETIC-GAP HEIGHT:	H_{AG} (IN)	0.32
	H_{AG} (MM)	8.13
VOICE-COIL HEIGHT:	H_{VC} (IN)	0.75
	H_{VC} (MM)	19.05
MAXIMUM EXCURSION:	X_{MAX} (IN)	0.22
	X_{MAX} (MM)	5.46

IMPEDANCE CURVE

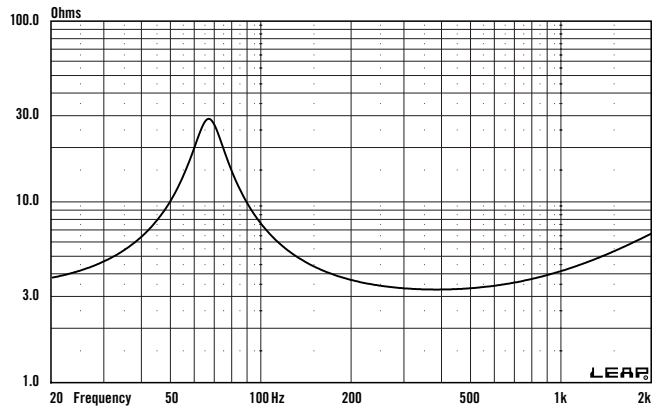

INFINITE Baffle FREQUENCY RESPONSE @ 2.83 V

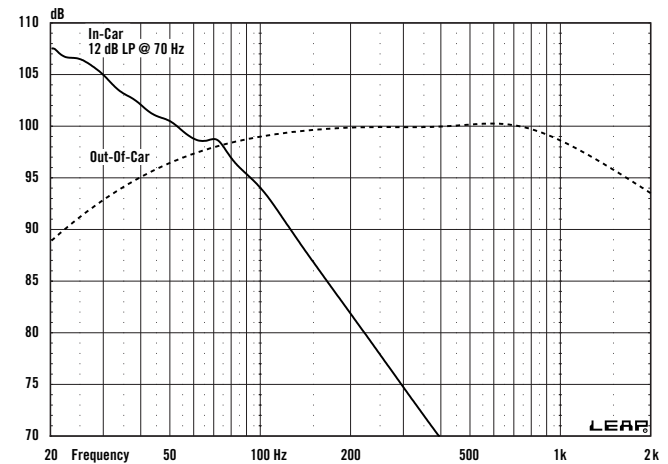

INFINITE Baffle EXCURSION/GROUP DELAY @ 150 W

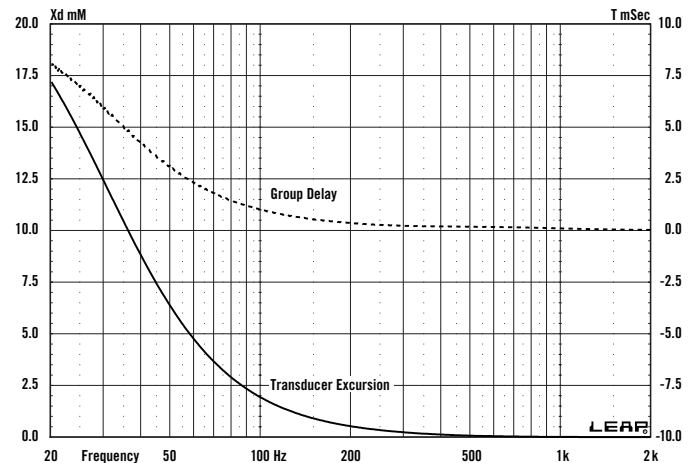

SEALED BOX VOLUME

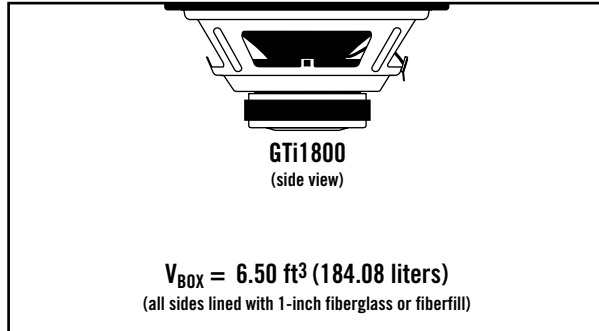

VENTED BOX VOLUME

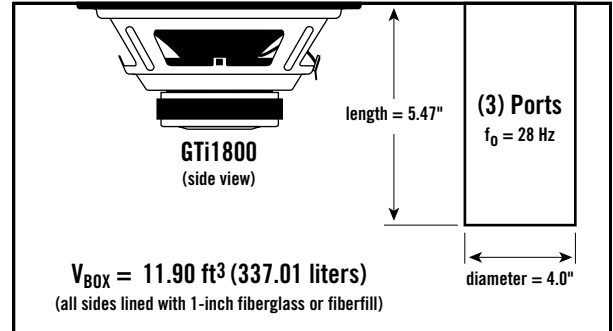

SEALED FREQUENCY RESPONSE @ 2.83 V

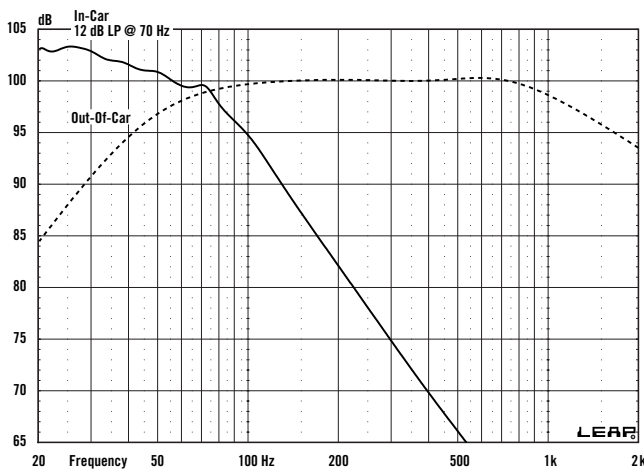

VENTED FREQUENCY RESPONSE @ 2.83 V

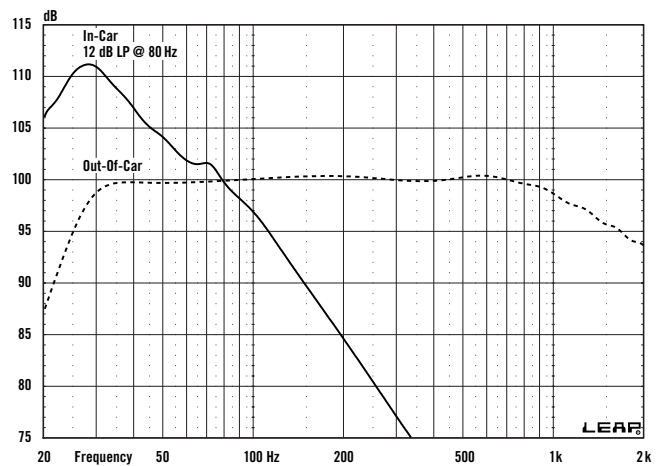

SEALED EXCURSION/GROUP DELAY @ 600 W

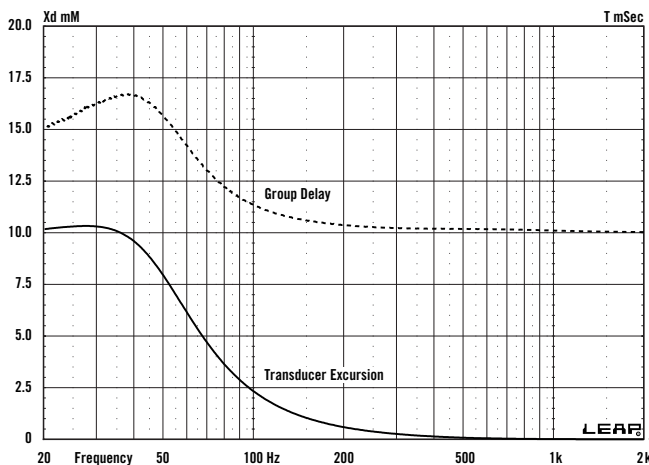

VENTED EXCURSION/GROUP DELAY @ 600 W

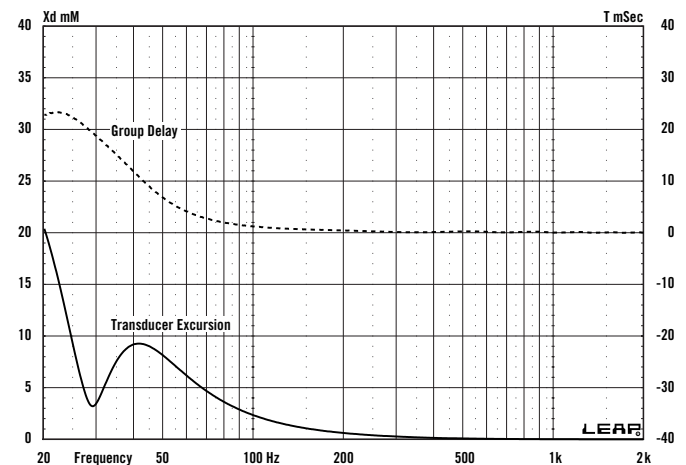



1800GTi18" Woofer – Technical Data

SEALED BANDPASS BOX VOLUME

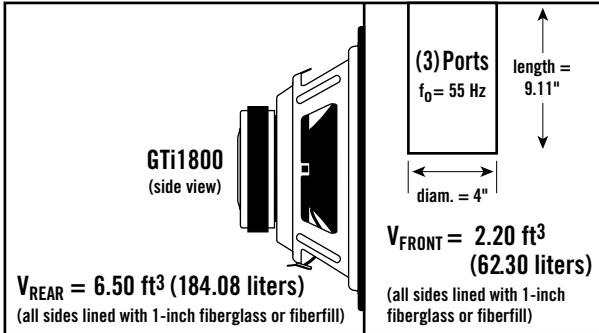

NOTES

SEALED BANDPASS FREQUENCY RESPONSE @ 2.83 V

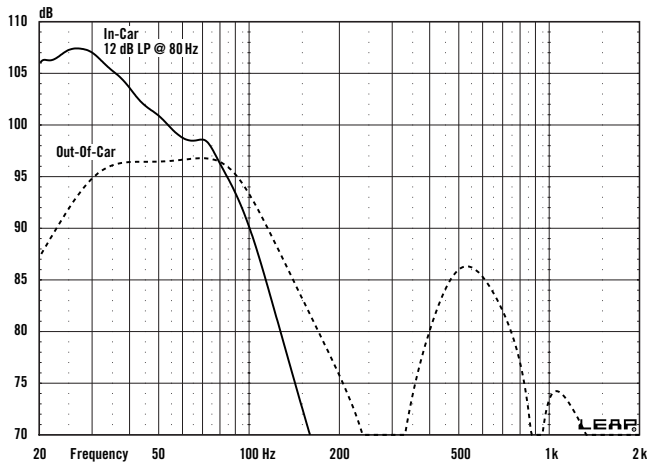

SEALED BANDPASS EXCURSION/GROUP DELAY @ 600 W

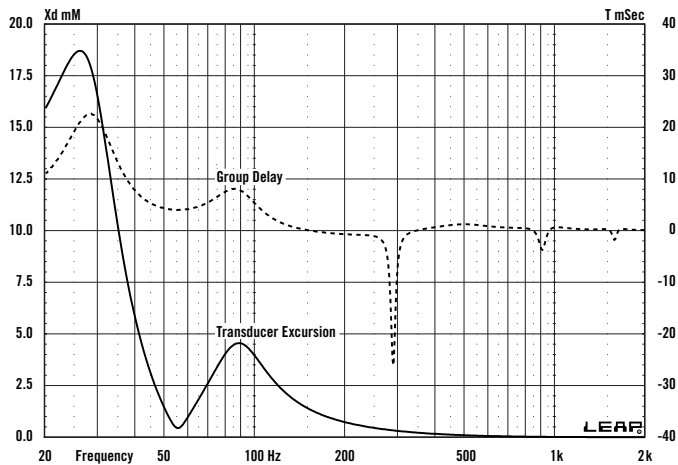

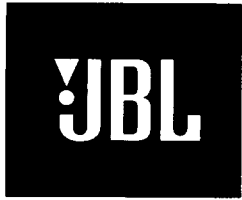

SUGGESTED ENCLOSURES FOR THE JBL 1800GT SUBWOOFER

ENCLOSURE VOLUME	PORT DIAMETER	PORT LENGTH	PORT TUNED FREQ.	*-3DB LOW CUTOFF	** INTERNAL DIMENSIONS	
					RECTANGULAR BOX H x W x D	WEDGE SHAPED BOX H x W x D1 x D2 x F
3.5 cu. ft.	4" dual 3"	12.6" 15.3"	25Hz	51Hz	19" x 30.7" x 11.8"	16.6" x 26.8" x 20.5" x 10.3" x 19.5"
4 cu. ft.	4" dual 3"	10.7" 13.1"	25Hz	49Hz	19.7" x 32" x 12.2"	17.2" x 27.9" x 21.4" x 10.7" x 20.3"
4.5 cu. ft.	4" dual 3"	9.2" 11.4"	25Hz	47Hz	20.4" x 33.1" x 12.7"	17.8" x 28.9" x 22.1" x 11.1" x 21"
5 cu. ft.	5" dual 3"	10.9" 8.3"	27Hz	45Hz	21" x 34.1" x 13"	18.4" x 29.8" x 22.8" x 11.4" x 21.6"
5.5 cu. ft.	5" dual 3"	9.6" 7.3"	27Hz	43Hz	21.7" x 35.1" x 13.4"	18.9" x 30.7" x 23.5" x 11.7" x 22.3"
6.5 cu. ft.	5" dual 4"	5.4" 8.7"	30Hz	39Hz	22.8" x 37" x 14.1"	19.9" x 32.3" x 24.7" x 12.4" x 23.4"
10 cu. ft.	dual 4" dual 5"	3" 5.5"	34Hz	32Hz	26.2" x 42.4" x 16.2"	22.9" x 37" x 28.3" x 14.2" x 26.9"
3 cu. ft. Isobarik	5" dual 3"	16" 12"	30Hz	41Hz	18.1" x 29.3" x 11.2"	15.8" x 25.6" x 19.6" x 9.8" x 18.6"
5 cu. ft. Isobarik	dual 3" dual 4"	6.3" 12.2"	30Hz	32Hz	21" x 34.1" x 13"	18.4" x 29.8" x 22.8" x 11.4" x 21.6"

*Frequency at which speakers' output begins to diminish when measured in an open air environment.
Actual in car frequency response will yield a much lower -3db point due to the effects of the cars' interior.

**Box dimensions are adjusted to allow for the volume displaced by the speaker and port tubes. Enclosures are net box volumes.

Thiele/Small Parameters Fs: 30Hz Qts: .43 Vas: 12.8 cu. ft. Eff: 2.07% Pe: 600w Xmax: .30 Dia: 15.83"
Qes: .456 Qms: 6.77 Re: 2.5 ohm Le: .98 mh Vd: 59 cu. in. Sd: 197 sq. in. Nom Z: 4.0 ohms Min Z: 3.2 ohms At: 25 Hz

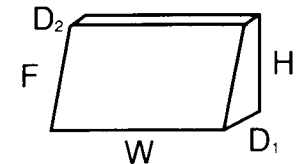
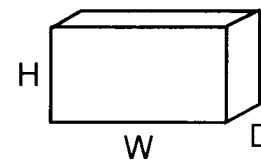

SUBWOOFER ENCLOSURE CONSTRUCTION NOTES

JBL recommends the use of ported, bass reflex type enclosures for our drivers. Properly designed ported enclosures offer several advantages that make them especially suitable for car stereo applications. These advantages include:

1. Smaller enclosure sizes.
2. Extended low frequency response.
3. Increased power handling.
4. Lower distortion.
5. Increased efficiency.

Each suggested enclosure has been computer designed to offer the best possible combination of these benefits with bass response that sounds tight and deep (no boomy one note bass here folks).

* The 1800GTi is capable of very high sound pressure levels. To minimize the possibility of a fractured (!) enclosure, use minimum 1" thick high density particle board or MDF to construct the enclosure. All seams must be air tight to ensure proper box tuning and to avoid cabinet whistles. The enclosure should be adequately braced to increase rigidity and minimize cabinet resonances. Use approximately 1" of fiberglass or Dacron to line the interior walls of the box (do not apply to the baffle board).

* Box dimensions are for individual drivers. Dimensions can be altered as long as the internal volume of the box remains the same. For dual drivers, build an enclosure that is twice as wide as a single driver enclosure with a center divider that splits the box into two individual boxes. Each chamber should then be lined, braced, and ported as if it were a single box.

* Ports can be constructed using PVC pipe or cardboard tubing (min. 1/16" wall thickness). The placement of the port in the enclosure is not critical as long as the port is vented into the interior of the car and the ends of the port tube are at least one port diameter away from the interior walls of the enclosure and the interior surfaces of the car. If the enclosure is too shallow to accommodate the required port tube, an L shaped port tube can be created using PVC pipe and a "swept elbow". Swept elbows have a gradual bend in them which will minimize any air turbulence in the port tube. Swept elbows can be purchased at any major home improvement or plumbing supply store.

* Isobarik enclosures are dual driver enclosures. In an Isobarik enclosure the drivers are mounted piggyback, one behind the other, both facing in the same direction, in a dual chamber enclosure. The box dimensions and ports given are for the rear speaker chamber only. The front speaker should be mounted in it's own smaller sealed chamber which is just large enough to place the magnet of the front speaker approximately one half the speaker's diameter away from the cone of the rear speaker. Another variation of an Isobarik enclosure is a Compound Push-Pull enclosure. In a Compound Push-Pull enclosure, a second driver is mounted face to face (like a clamshell) to the front of a driver mounted in a regular ported enclosure. The speakers should be wired out of phase (so they are both moving in the same direction) and a spacer should be installed between the drivers to keep the drivers' surrounds from hitting each other.