

SPECIFICATIONS

DIAMETER:	12" (304.8 mm)
SENSITIVITY (2.83 V @ 1 m):	93 dB
POWER HANDLING:	250 W _{RMS} (1,000 W _{PEAK})
FREQUENCY RESPONSE:	23 ~ 450 Hz
NOMINAL IMPEDANCE:	4 OHMS
VOICE-COIL DIAMETER:	2.0" (50.8 mm)

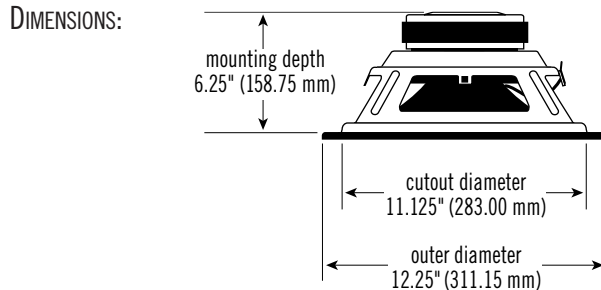

THIELE-SMALL PARAMETERS

VOICE COIL DC RESISTANCE:	R_{EVC} (OHMS)	3.56
VOICE COIL INDUCTANCE @ 1 kHz:	L_{EVC} (MH)	2.54
DRIVER RADIATING AREA:	S_D (IN ²)	82.31
	S_D (CM ²)	531.00
MOTOR FORCE FACTOR:	BL (TM)	14.78
COMPLIANCE VOLUME:	V_{AS} (FT ³)	3.22
	V_{AS} (LITERS)	91.12
SUSPENSION COMPLIANCE:	C_{MS} (µM/N)	227.58
MOVING MASS, AIR LOAD:	M_{MS} (GRAMS)	181.74
MOVING MASS, DIAPHRAGM:	M_{MD} (GRAMS)	174.70
FREE-AIR RESONANCE:	F_S (HZ)	24.75
MECHANICAL Q:	Q_{MS}	6.46
ELECTRICAL Q:	Q_{ES}	0.46
TOTAL Q:	Q_{TS}	0.43
MAGNETIC-GAP HEIGHT:	H_{AG} (IN)	1.30
	H_{AG} (MM)	33.00
VOICE-COIL HEIGHT:	H_{VC} (IN)	0.31
	H_{VC} (MM)	8.00
MAXIMUM EXCURSION:	X_{MAX} (IN)	0.49
	X_{MAX} (MM)	12.50

SEALED BOX VOLUME (INCLUDES DRIVER DISPLACEMENT)

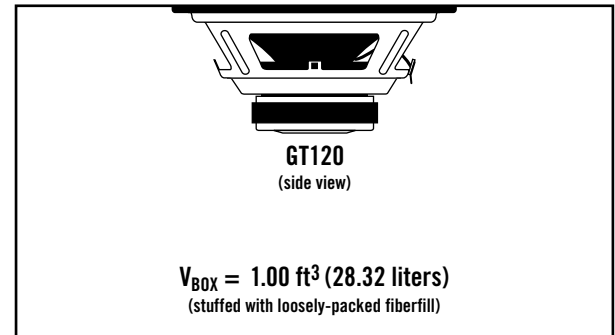

SEALED FREQUENCY RESPONSE @ 2.83 V

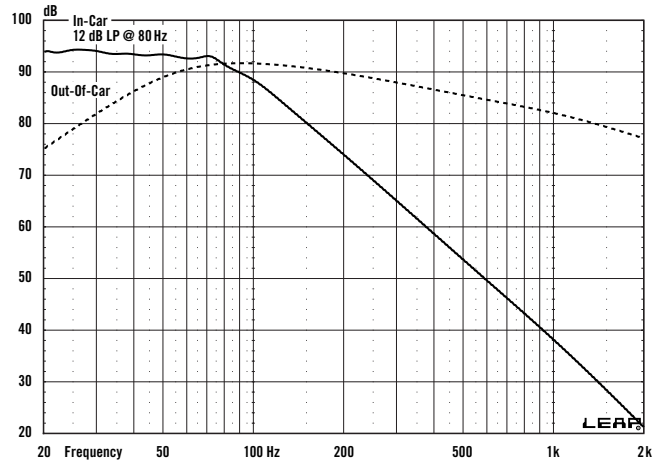

SEALED TRANSDUCER EXCURSION @ 300 W

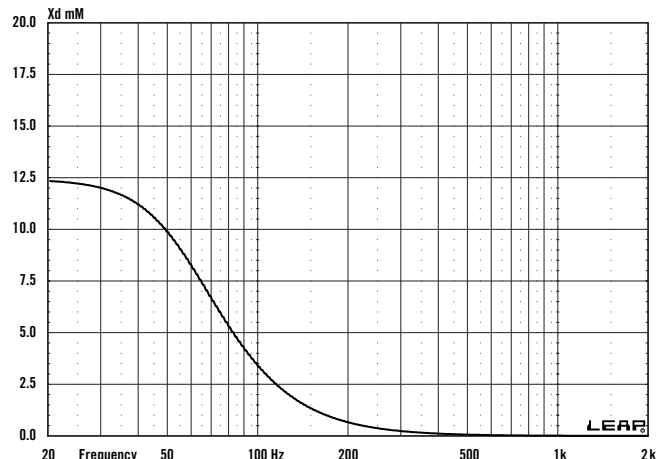



GT120 12" Woofer – Technical Data

VENTED BOX VOLUME (INCLUDES DRIVER/PORT DISPLACEMENTS)

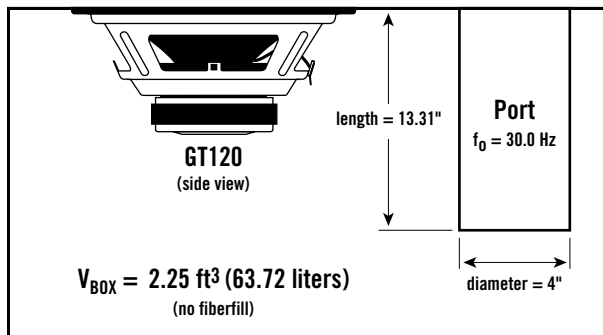

SEALED BANDPASS BOX VOLUME (INCLUDES DRIVER/PORT DISPLACEMENTS)

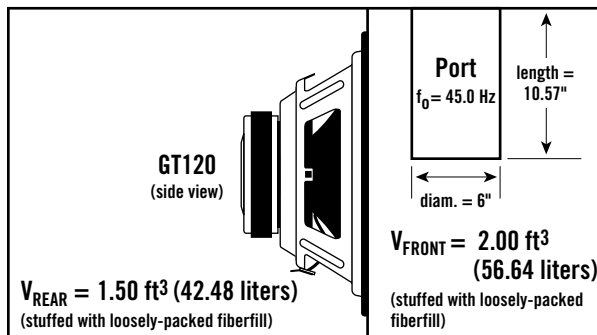

VENTED FREQUENCY RESPONSE @ 2.83 V

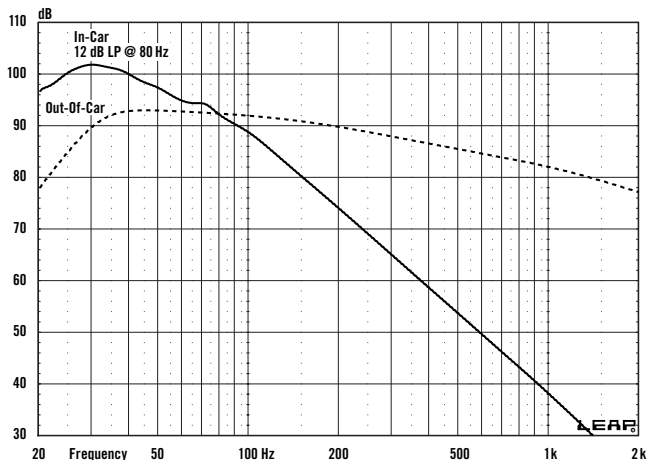

SEALED BANDPASS FREQUENCY RESPONSE @ 2.83 V

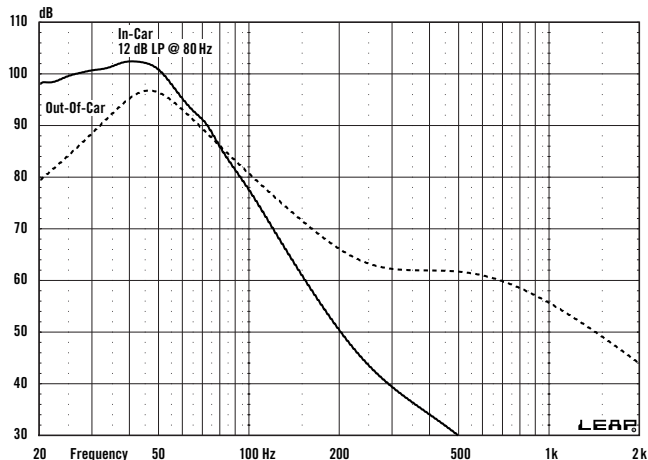

VENTED TRANSDUCER EXCURSION @ 300 W

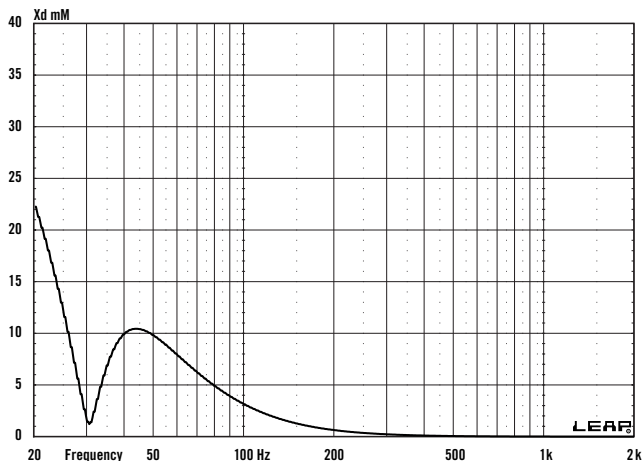

SEALED BANDPASS TRANSDUCER EXCURSION @ 300 W

