

Professional Series Radial Horn Family

**Wide horizontal-narrow vertical dispersion
For short-throw use
Uncolored musical reproduction
Compact and lightweight
Uniform wavefront**

Professional audio consultants and engineers are invited to compare JBL radial horns with other radial horns, both on the basis of acoustical measurements and extended listening tests.

JBL radial horns are carefully designed according to advanced theoretical concepts and offer the audio engineer significant advantages in many sound reinforcement and sound reproduction applications. The most important of these are natural tonal quality, a controlled pattern of sound distribution through the full frequency range of the horn, and uniform frequency response characteristics at any point within the rated coverage angle.



Radial Horn Family

In JBL radial horns, the wavefront expands smoothly through a single, unobstructed path. There are no dividers or discontinuities to introduce irregularities in response and consequent tonal coloration. All models except 2356 are cast from aluminum, with thick wall sections to prevent flexing. Exterior surfaces are coated with a heavy layer of special Lans-a-plas damping material to further guard against unwanted coloration or ringing.

Because the side walls of JBL radial horns are perfectly straight, the horizontal distribution pattern has sharply defined edges at all frequencies within the normal operating range of the device. In the vertical plane, the beam has a somewhat "softer" edge, becoming less directional at lower frequencies. As a result of JBL's exclusive throat design, frequency response is remarkably uniform throughout the rated dispersion pattern, even at very high frequencies.

In comparison with multicell designs, JBL radial horns offer audibly smoother response and a more sharply defined horizontal pattern with complete freedom from high frequency "fingering". In general, these radial horns produce the effortless, natural quality of JBL horn-lens combinations, but with much tighter pattern control.

Except for the right-angle Model 2340, all JBL radial horns can be stacked to obtain greater directionality in the vertical plane and an attendant increase in sensitivity. For example, stacking four 2350 horns in a vertical array reduces the effective vertical coverage from 40° to 15° and boosts sensitivity several dB as compared with a single horn-driver.

Model	Width	Height	Depth	Weight
2340	8-3/8"	8-3/8"	8-5/16"	6
2345	23"	5-1/2"	15-1/2"	20
2350	31-5/8"	8"	20"	36
2355	24-1/8"	8"	20"	36
2356	33"	16-1/2"	48-3/4"	26

Model 2340

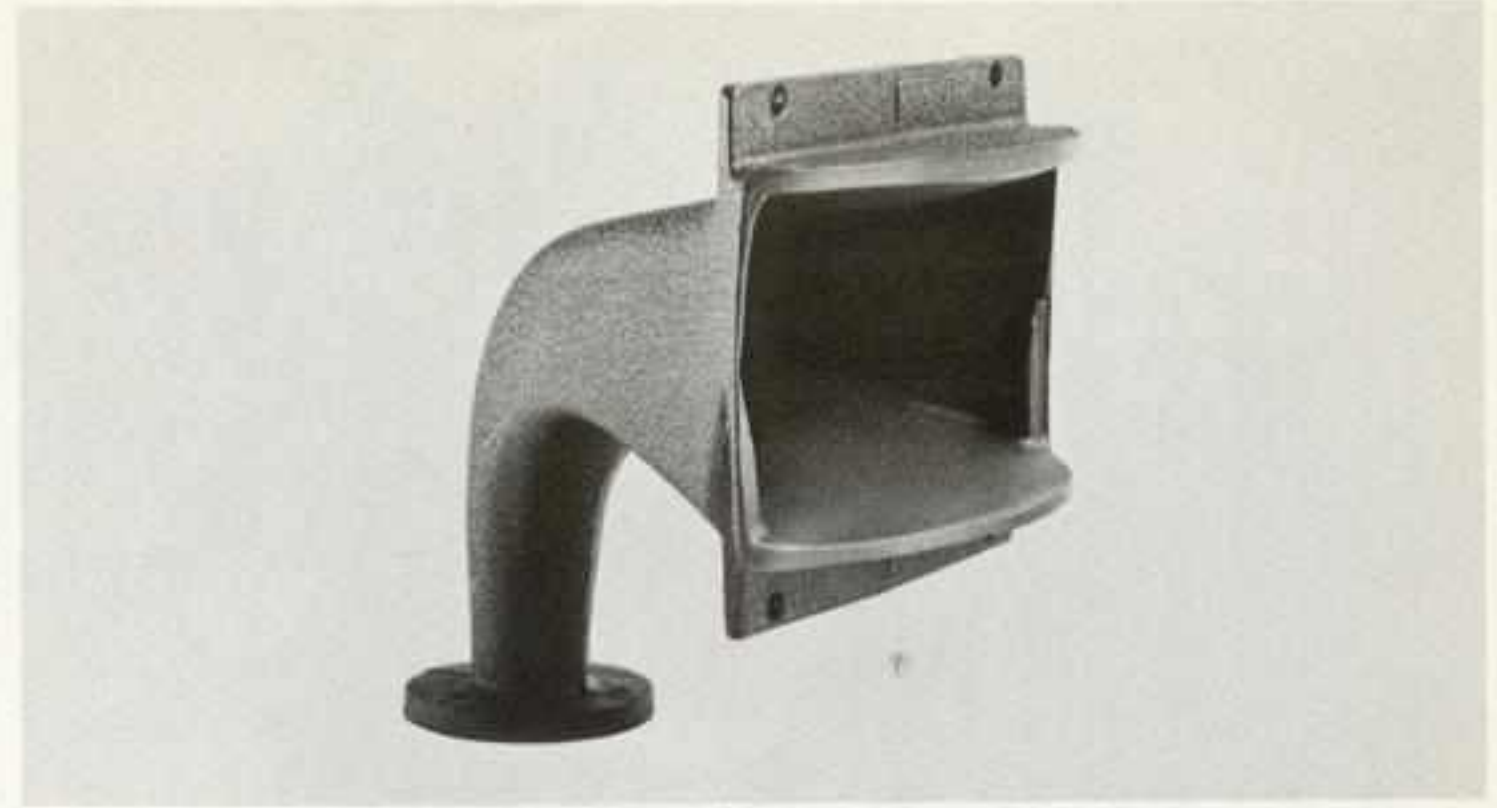

Model 2340 is a special modification of the radial horn configuration in which the horn throat includes a right-angle bend, thus allowing the horn-driver assembly to be used in shallow spaces. A unique cross-section development through the 90° bend maintains full horizontal coverage even at highest audible frequencies. Model 2340 has a rated pattern of 40° x 80° and is intended for use in systems having a 1200 Hz crossover frequency. (An 800 Hz crossover may be used with some loss of pattern control below 1000 Hz.) The horn is intended to be mounted to a baffle board, and includes flush-mount flanges as part of the heavy aluminum casting. The 2340 will mount to any JBL driver having a one-inch throat.

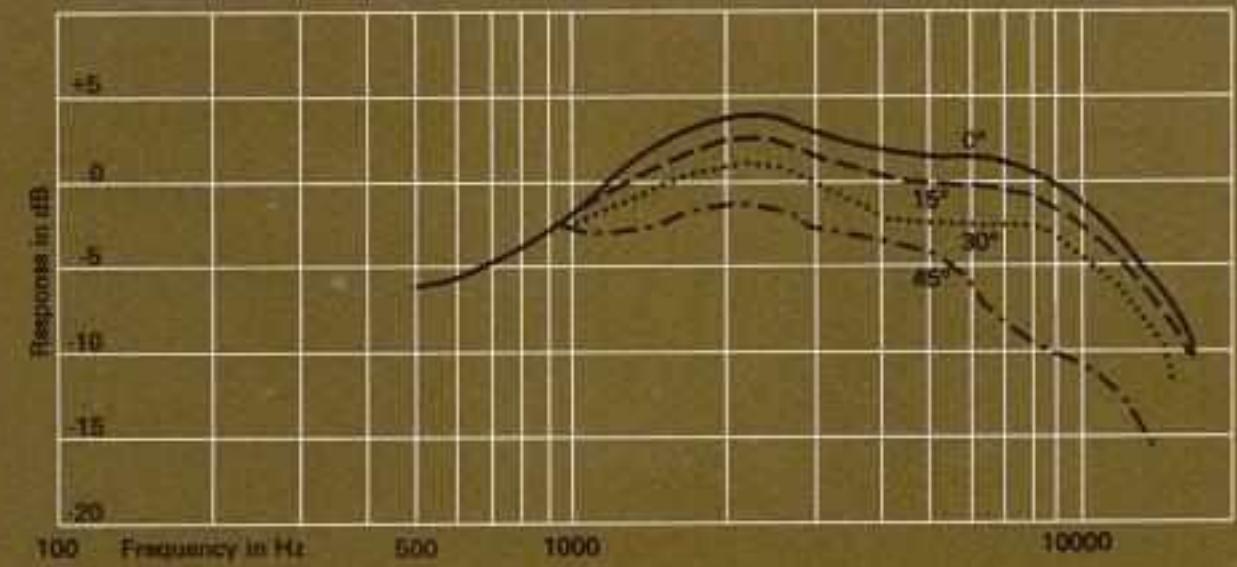

Model 2340 Vertical Dispersion

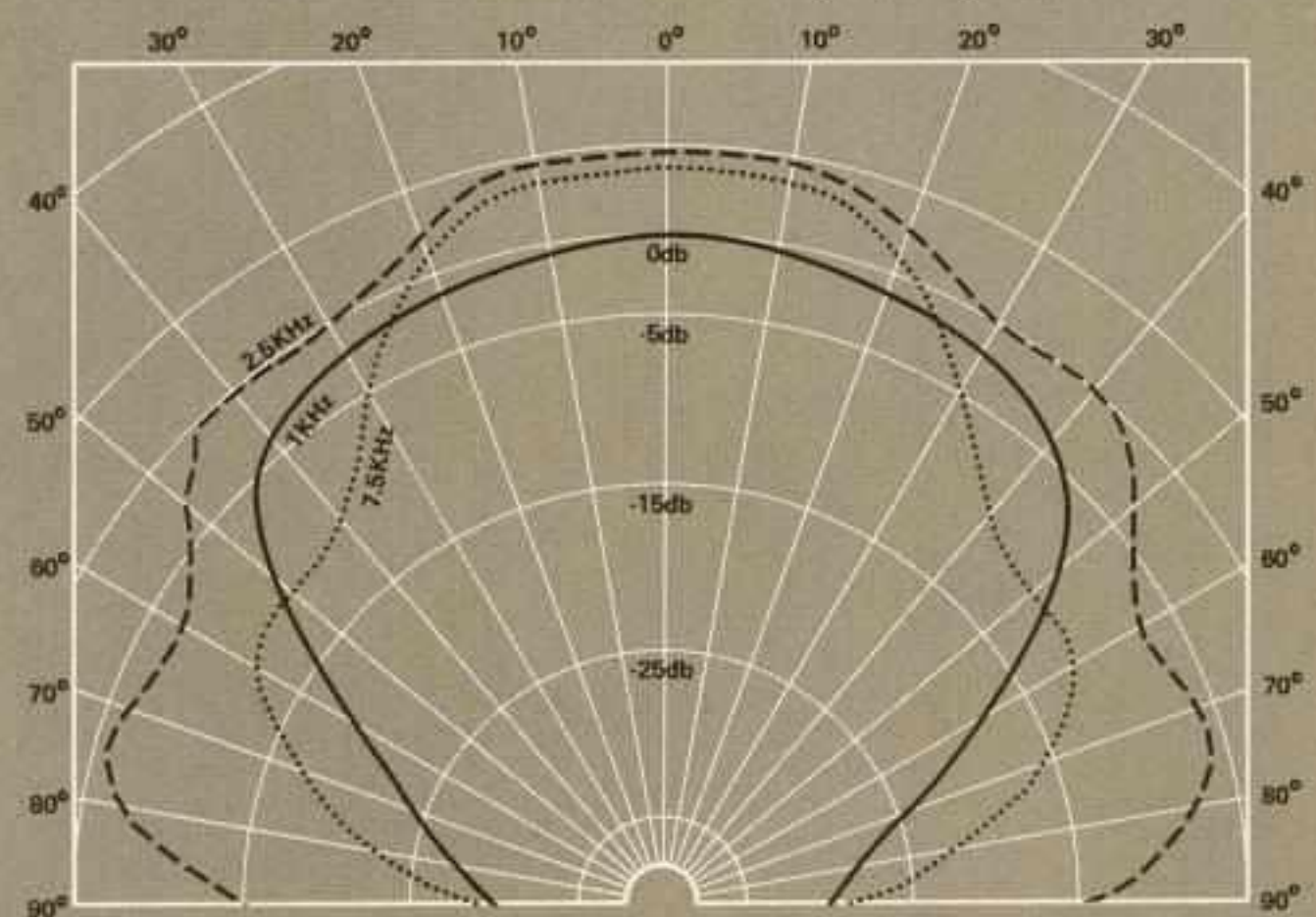

Model 2340 Lateral Dispersion

Model 2345

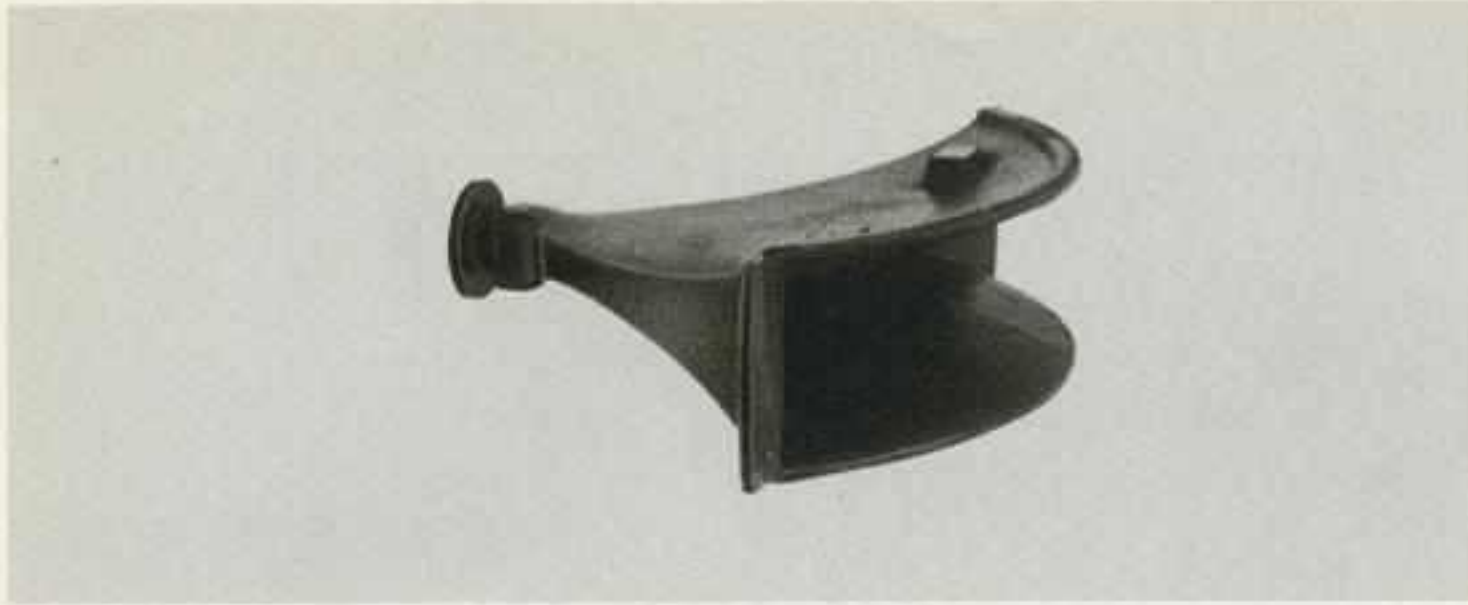

Model 2345 is a compact radial horn having a rated pattern of $40^\circ \times 90^\circ$. It will mount directly to any JBL compression driver having a one-inch throat and is intended for use in systems crossing over at 800 Hz or higher. Model 2345 is especially recommended for short-throw reinforcement applications or portable loudspeaker systems, where larger horns are not practical.

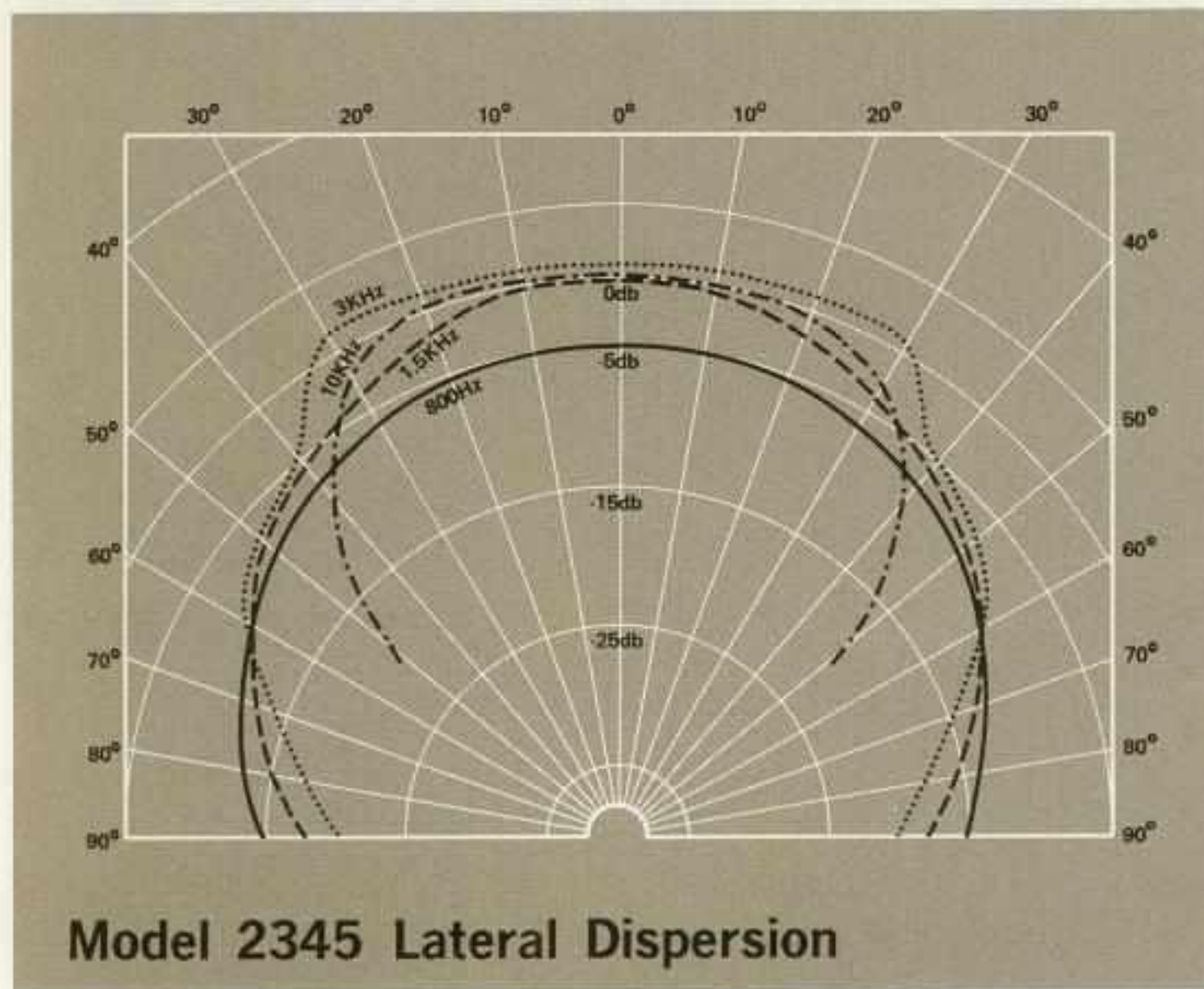
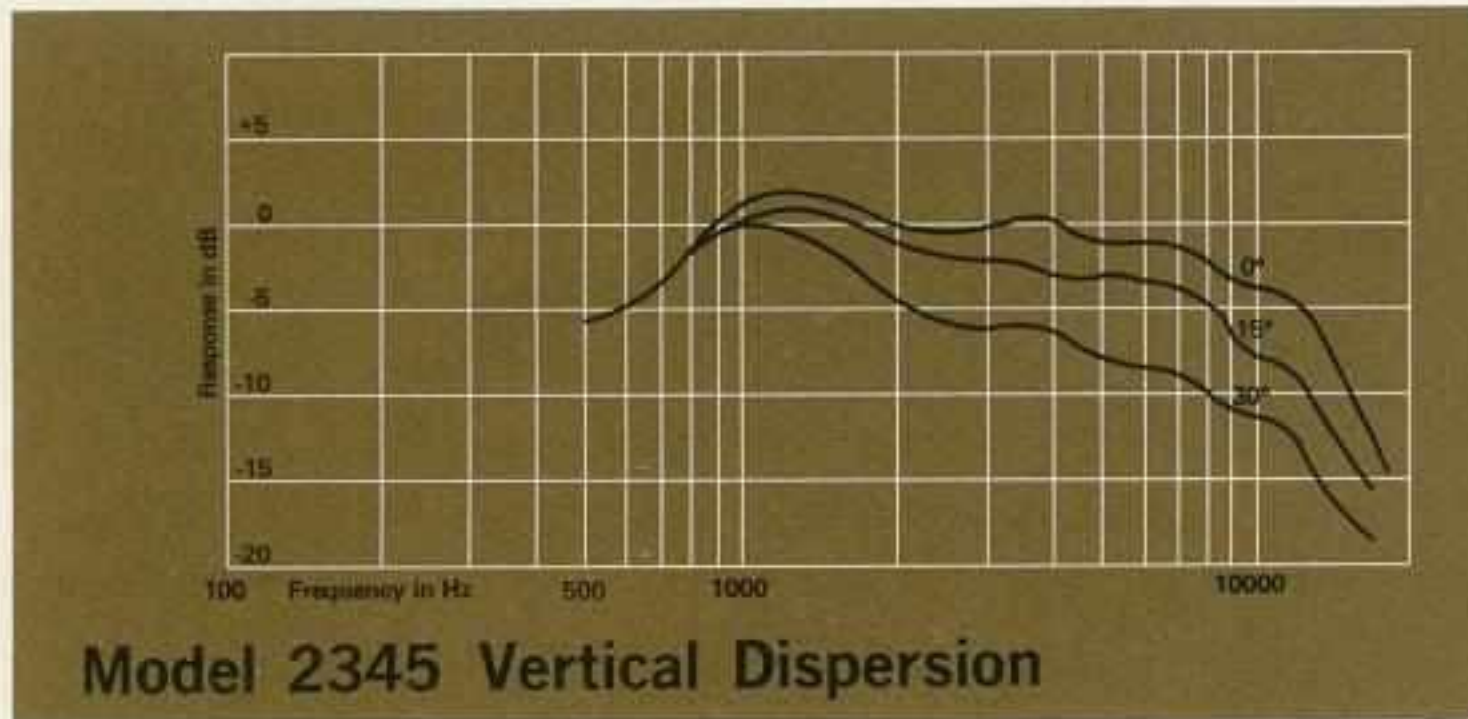

Model 2350

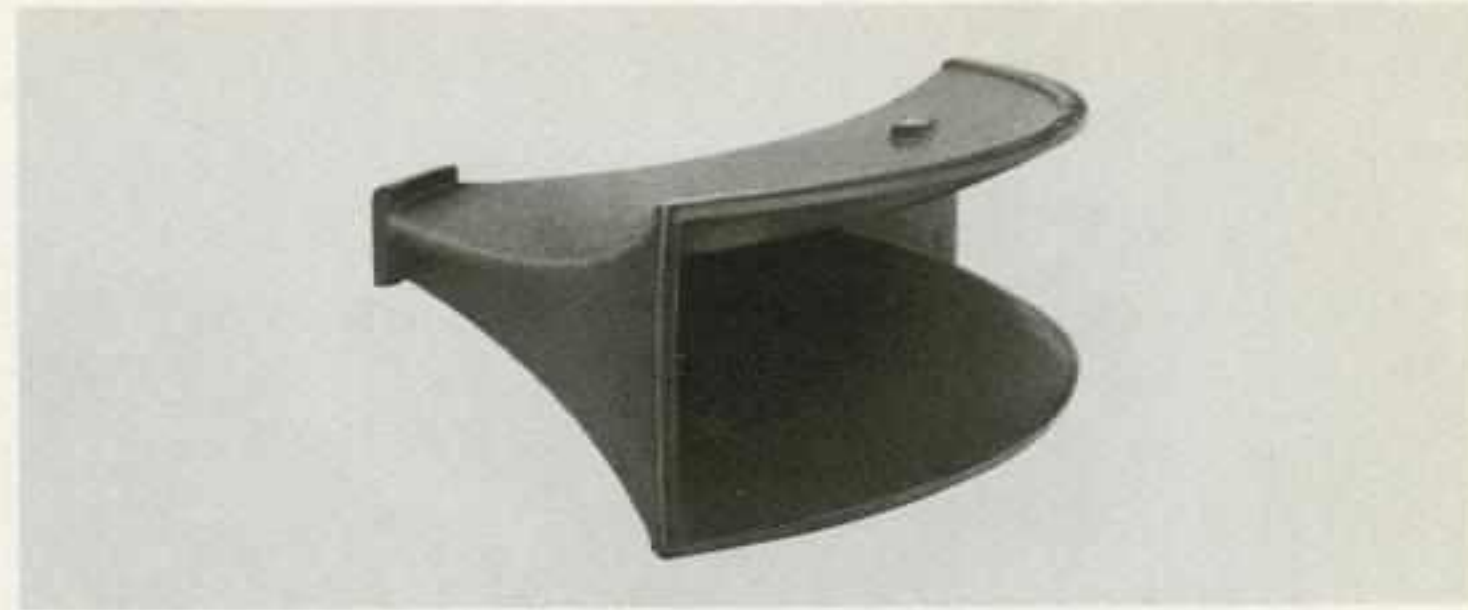

Model 2350 is a large, professional quality radial horn having a 220 Hz taper cutoff and carefully controlled coverage pattern rated at $40^\circ \times 90^\circ$. The horn is intended for use in systems crossing over at 500 Hz or higher, or may be used by itself with one or two phenolic-diaphragm drivers in speech-only systems having suitable low frequency rolloff.

The 2350 requires the use of a Model 2328 throat adaptor to couple to a single two-inch throat driver, or a Model 2329 throat adaptor for use with two drivers. Additional Model 2327 throat extensions can be used to couple the 2350 to one or two JBL drivers having one-inch throats.

The 2350 is a highly versatile horn which can be used in a wide variety of applications ranging from high-power outdoor paging systems to low-distortion musical reinforcement installations of the highest quality.

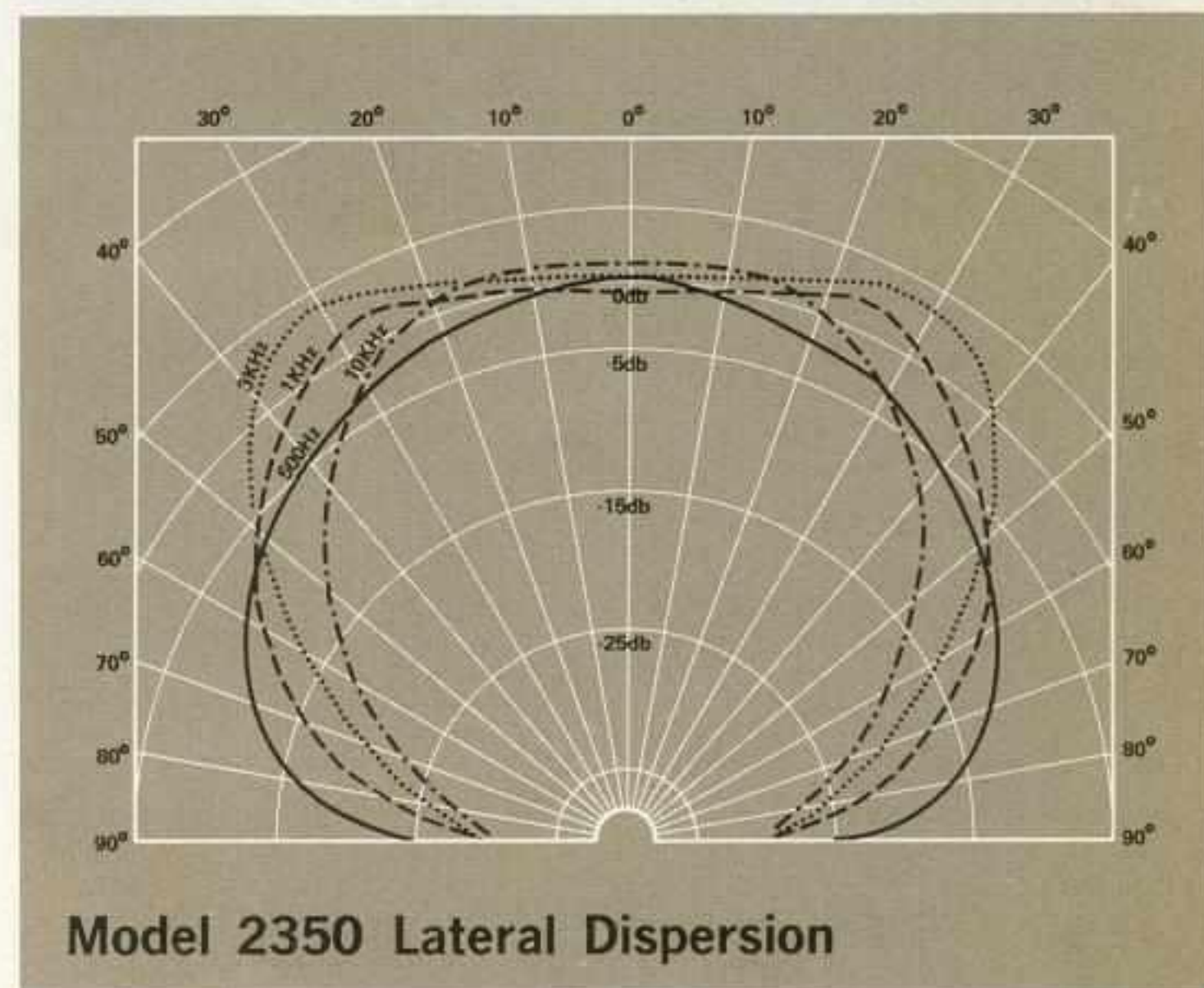
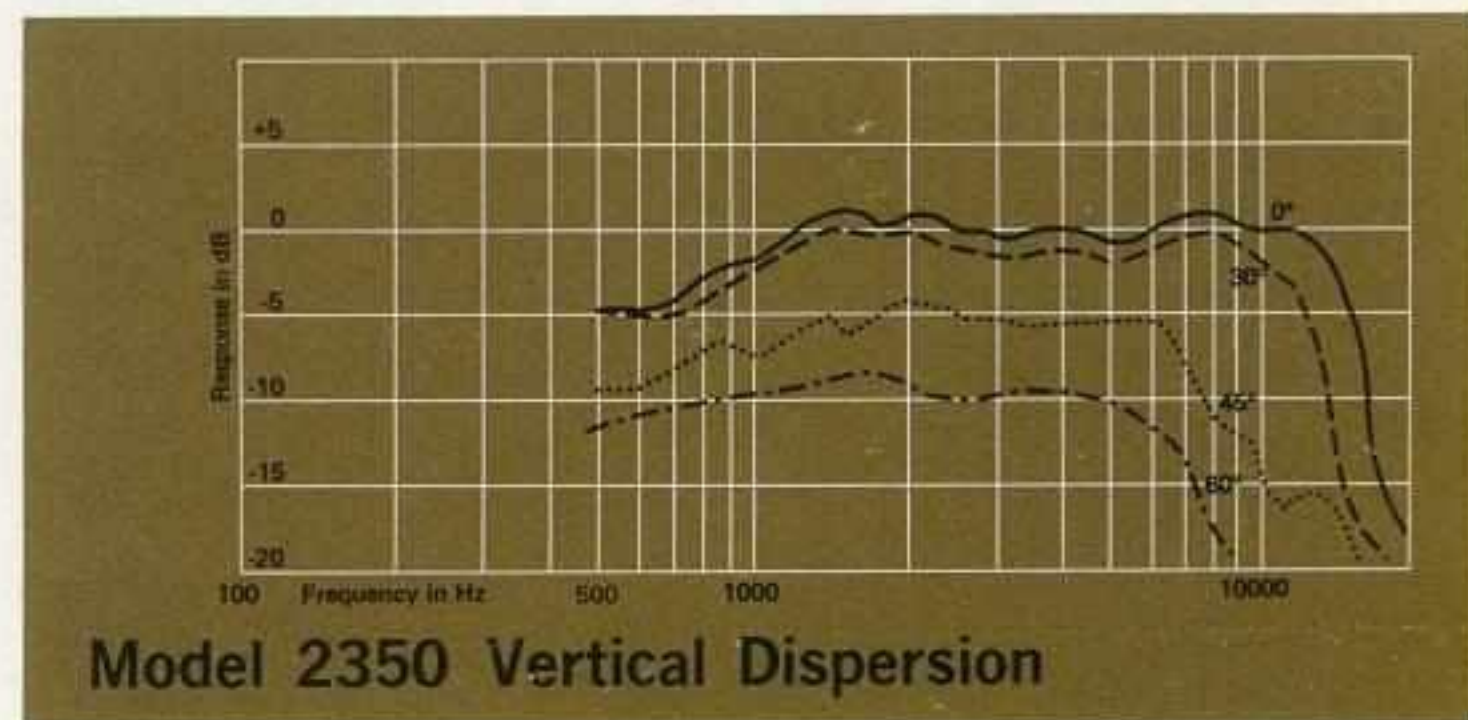

Model 2355



The general performance specifications and application notes for Model 2355 are exactly the same as those for Model 2350, except that rated coverage is 40° x 60°.

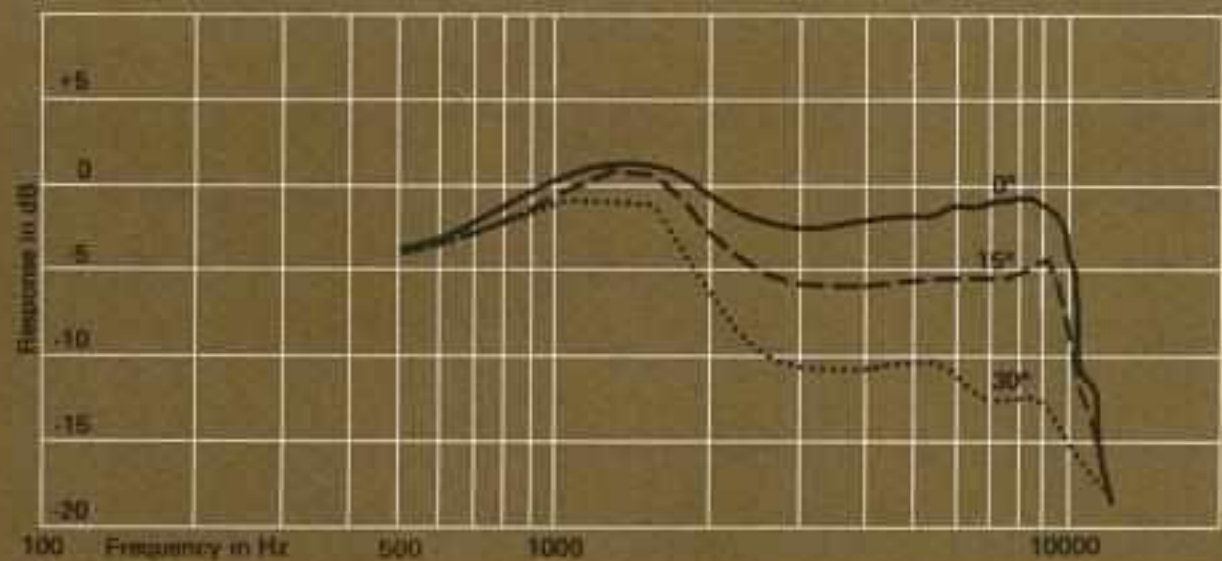

Model 2355 Vertical Dispersion

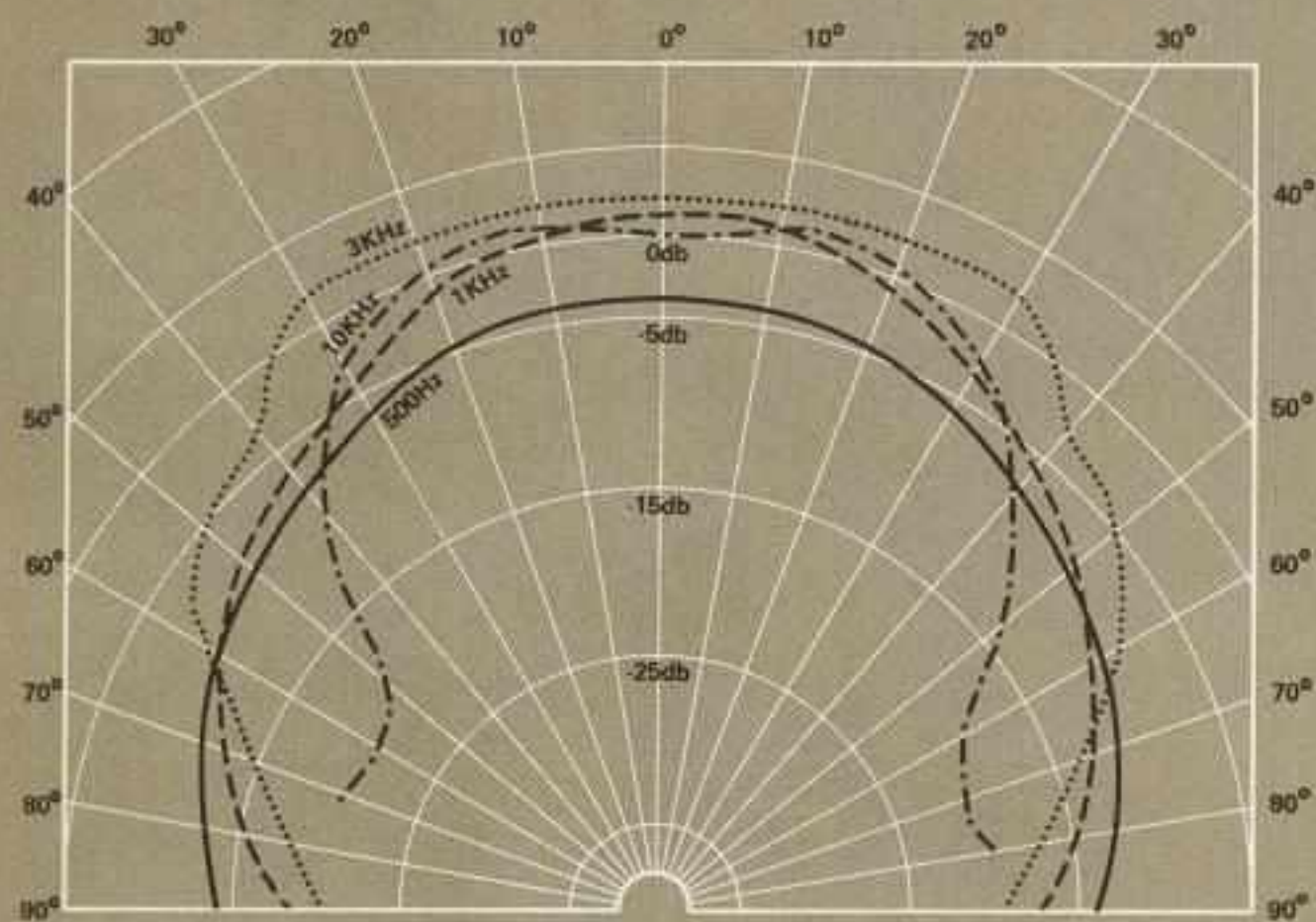

Model 2355 Lateral Dispersion

Model 2356

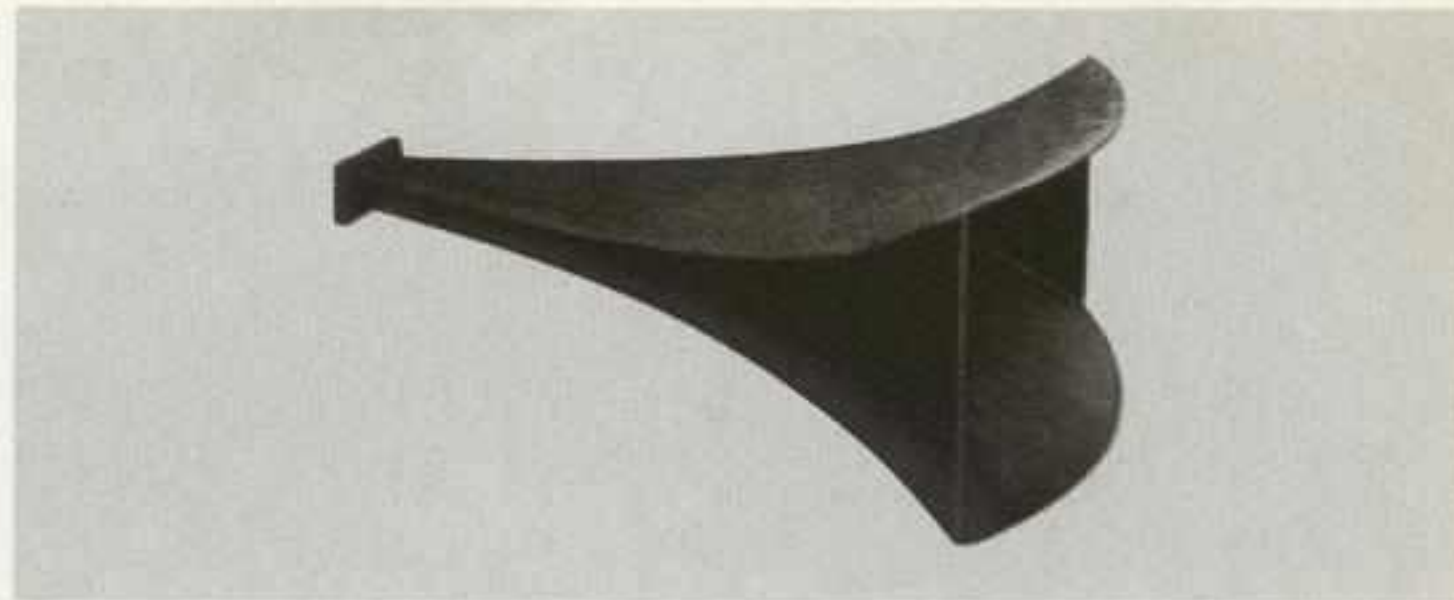

Model 2356 is a unique design making use, for the first time, of the radial expansion principle in a full-size horn designed for long-throw applications. Its rated coverage of only 40° horizontal by 20° vertical is maintained through the full frequency range of the horn (even below the conventional 500 Hz crossover frequency) with the result that a favorable ratio of direct-to-reflected sound can be achieved at distances of 500 feet or more. The taper cutoff of the horn is a low 120 Hz, well below the capabilities of associated compression drivers.

When used with the JBL 2480 driver, Model 2356 provides the most powerful and efficient single-driver speech reproducing system available; at a distance of 30 feet, an electrical input of one watt produces a sound pressure level of almost 100 dB!

The horn is constructed of a non-metallic "sandwich" to achieve freedom from resonances while keeping weight to a minimum. A single JBL 2-inch throat driver can be mounted to the 2356 by using the integral throat, or a pair of drivers can be mounted by using the Model 2331 double throat adaptor.

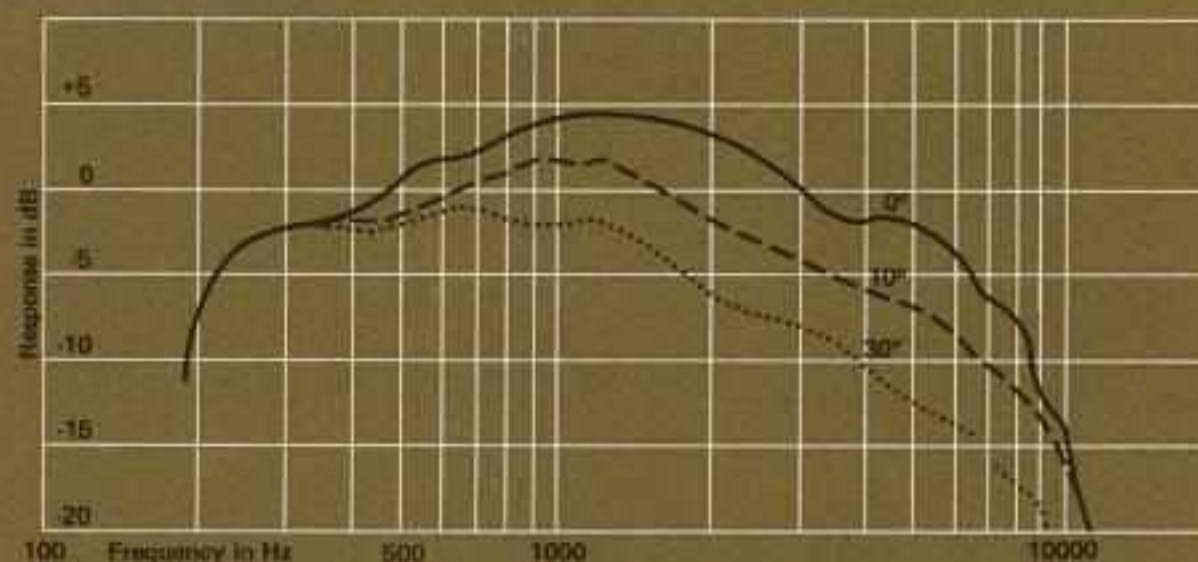

Model 2356 Vertical Dispersion

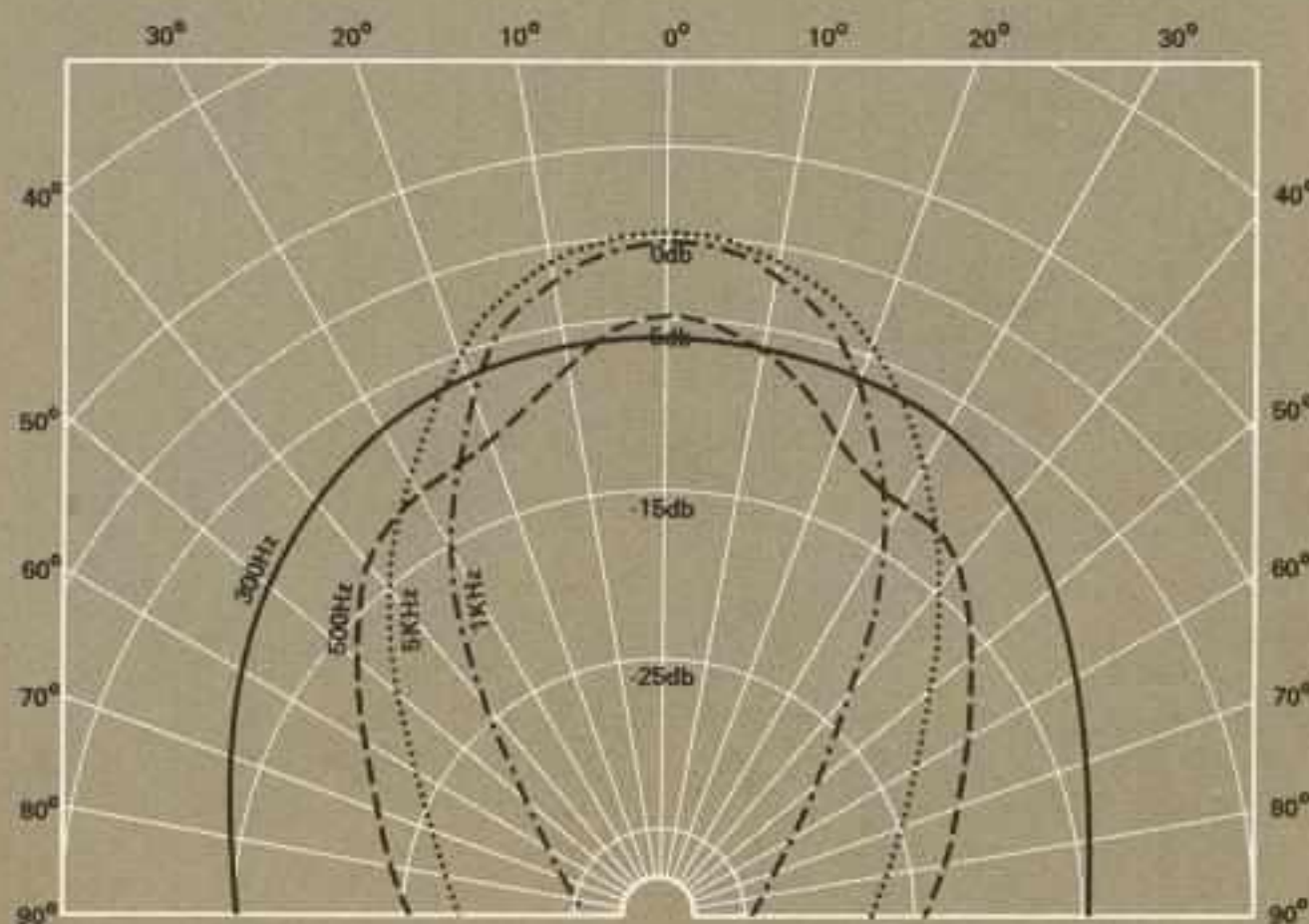

Model 2356 Lateral Dispersion