



## ► 4430, 4435 Bi-Radial® Studio Monitors

### Low Frequency Transducer

The low frequency loudspeakers used in the Bi-Radial monitors incorporate the latest technology to deliver smooth response, extended bandwidth, and extremely low distortion. The magnetic structures feature JBL's Symmetrical Field Geometry (SFG) design to reduce second harmonic distortion to inconsequential levels. New adhesives technology and coil former construction improve power handling. The voice coil, 100 mm (4 in) in diameter, is fabricated from edge-wound copper ribbon, and operates in a magnetic field having a flux density of 1.2 T (12,000 gauss). The 19 mm ( $\frac{3}{4}$  in) length of the voice coil allows increased linear excursion, and a careful choice of suspension elements helps to completely eliminate dynamic instabilities.

The 4430 and 4435 differ chiefly in their low frequency capabilities. The 4430 uses a single 380 mm (15 in) low frequency driver and is 3 dB down at 32 Hz; it can handle full power input to 27 Hz. The 4435 is designed for applications requiring greater low frequency output and uses a pair of 380 mm (15 in) low frequency drivers; the second operates below 100 Hz, in parallel with the first. The system is down 3 dB at 27 Hz and will handle full power down to 22 Hz. Compared to the 4430, the 4435 is capable of 3 dB to 4 dB greater output from 35 Hz to 600 Hz, and 6 dB to 12 dB more output in the important low bass range of 20 Hz to 35 Hz. When operated at the same level as the smaller system, the 4435 generates about one-half to one-tenth the distortion in the low frequency range. The two systems use similar low frequency drivers, but the cone assemblies in the 4435 are lighter in weight for increased efficiency (+ 3 dB).

### Frequency Dividing Network

The frequency dividing network of the Bi-Radial monitors has a crossover frequency of 1 kHz and a nominal slope of 12 dB per octave. The cutoff slope and shape were chosen to provide the smoothest possible response over the widest bandwidth, restricting any off-axis anomalies to a very narrow portion. JBL has paid considerable attention to both the off-axis response and the total power response, and the network optimizes these parameters. While the response is smooth at all angles, the flattest response is, by design, on-axis and above. This offers a greater number of listening positions when the system is mounted at or below ear level; for mounting above ear level, the system can be inverted to offer the same advantages.

The network also provides equalization of the compression driver. Because the power response of the driver and the Bi-Radial horn is greater in the midrange than at high frequencies, this equalization attenuates the lower end of the compression driver's response, lowering distortion and giving greater dynamic headroom. The equalization is provided in two stages, allowing separate adjustments (via front-panel level controls) for the midrange and high frequencies.

A switch located adjacent to the connection terminals allows the monitor to be biamplified. A special crossover card is available for the JBL Model 5235 electronic frequency dividing network to provide the appropriate crossover characteristics.

Further information on the 4430 and 4435 can be found in a paper by D. Smith, D. Keele, Jr., and J. Eargle, *Improvements in Monitor Loudspeaker Systems*, published in the *Journal of the Audio Engineering Society*, Vol. 31, No. 6, June 1983. Copies are available from JBL Professional.

Figure 1. Acoustic Alignment (4430).

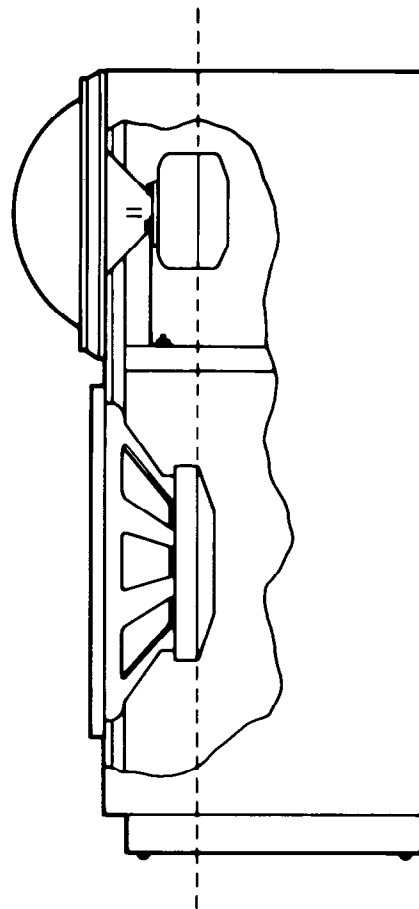

## Specifications:

SYSTEM	4430	4435
<b>SMALL SIGNAL, RESPONSE AND DIRECTIVITY</b>		
Frequency Response:	35 Hz – 16 kHz ± 3 dB	30 Hz – 16 kHz ± 3 dB
Sensitivity (1 W @ 1 m):	93 dB SPL	96 dB SPL
Efficiency (Half-space reference):	1.3%	2.6%
Dispersion Angle (Included by 6 dB down points, averaged between 1.25 kHz and 16 kHz)		
Horizontal:	100° (+0°, -30°)	100° (+10°, -30°)
Vertical:	100° (+0°, -30°)	100° (+0°, -30°)
Directivity (Averaged over 800 Hz to 16 kHz)		
Directivity Factor (Q):	8 (+4, -2)	8 (+4, -2)
Directivity Index (DI):	9 dB (+2, -1)	9 dB (+2, -1)
Group Delay Characteristics <sup>1</sup>		
300 Hz to 1.6 kHz:	500 μS (± 100 μS)	500 μS (± 100 μS)
smoothly changing to 2.5 kHz to 20 kHz:	0 μS (0, + 50 μS)	0 μS (0, + 50 μS)
Controls		
Mid Frequency:	-∞ to +4 dB @ 2 kHz	-∞ to +4 dB @ 2 kHz
High Frequency:	-∞ to +2 dB @ 12 kHz	-∞ to +0 dB @ 12 kHz
<b>LARGE SIGNAL, INPUT AND OUTPUT CHARACTERISTICS</b>		
Nominal Impedance:	8 ohms	8 ohms
Minimum Impedance:	>6 ohms (See Fig. 9)	>4 ohms (See Fig. 10)
Maximum Power Input Single Amplification		
Continuous Program <sup>2</sup> :	300 W	375 W
Continuous Sine Wave <sup>3</sup> :	See Fig. 11	See Fig. 11
Short-term Peak <sup>3</sup> (<10 ms):	2 kW	2 kW
Bi-amplification		
Continuous Sine Wave <sup>4</sup> :	See Fig. 11	See Fig. 11
Maximum Sound Pressure Level (SPL) <sup>5</sup>		
Continuous Program:	119 dB	122 dB
Continuous Sine Wave:	See Fig. 12	See Fig. 12
Recommended Amplifier Power, Bi-amplification		
Low Frequency:	200 W	400 W
High Frequency:	75 W	150 W
Power Linearity 1 W to 100 W	<1 dB	<1 dB
Continuous Input (See Fig. 13, 14):	Compression of SPL output	Compression of SPL output
Distortion (See fig. 15)		
At 100 dB SPL on-axis at 1 m:	(5 W input)	(2.5 W input)
Second Harmonic		
Low Frequencies (40-100 Hz):	≤2%	≤0.5%
Mid Frequencies (100-1000 Hz):	≤1%	≤0.25%
High Frequencies (1000-8000 Hz):	≤2%	≤2%
Third Harmonic		
Low Frequencies:	≤0.6%	≤0.15%
Mid Frequencies:	≤0.6%	≤0.6%
High Frequencies:	≤0.6%	≤0.6%

SYSTEM	4430	4435
At 110 dB SPL on-axis at 1 m: (50 W input)		(25 W input)
Second Harmonic		
Low Frequencies:	≤3%	≤0.75%
Mid Frequencies:	≤0.6%	≤0.3%
High Frequencies:	≤6%	≤6%
Third Harmonic		
Low Frequencies:	≤1%	≤0.25%
Mid Frequencies:	≤1%	≤1%
High Frequencies:	≤1%	≤1%
<b>GENERAL</b>		
Crossover Frequency <sup>6</sup> :	1 kHz	1 kHz (Second low frequency driver active below 100 Hz)
Driver Complement		
Low Frequency:	2235H	2234H(2)
Compression Driver:	2425H	2425H
Horn:	2344	2344
Dimensions:	908 mm x 552 mm	908 mm x 965 x
H x W x D	x 400 mm (480 mm deep w/ horn)	435 mm (515 mm deep w/ horn)
	35 <sup>3</sup> / <sub>4</sub> in x 21 <sup>7</sup> / <sub>8</sub> in	35 <sup>3</sup> / <sub>4</sub> in x 38 in
	x 15 <sup>3</sup> / <sub>4</sub> in (18 <sup>3</sup> / <sub>8</sub> in deep w/ horn)	x 17 <sup>7</sup> / <sub>8</sub> in (20 <sup>3</sup> / <sub>8</sub> in deep w/ horn)
Enclosure Volume (net):	0.143 (5 ft <sup>3</sup> )	0.28 m <sup>3</sup> (10 ft <sup>3</sup> ) (Divided into two separate subchambers)
Enclosure Helmholtz Resonance Frequency (f <sub>h</sub> ):	34 Hz	26 Hz
Finish:	Oiled walnut	Oiled walnut
Grille:	Stretch fabric	Stretch fabric
Grille Color:	Dark blue	Dark blue
Weight:	57.7 kg (127 lb)	102 kg (225 lb)
Shipping Weight:	79.5 kg (175 lb)	114 kg (250 lb)

<sup>1</sup>The high and low-frequency transducers of the system are aligned vertically and thus are on the same acoustic source plane. The indicated group delay characteristic for the system (Fig. 6) is entirely due to the gradually changing phase characteristic of the sharp-skirted even-order all-pass crossover network used in the system (a). The smooth delay response exhibited by the system is well below audibility thresholds as shown in (b-d).

<sup>2</sup>Rating based on test signal of filtered random noise conforming to international standard IEC 268-1 (pink noise with 12 dB per octave rolloff below 40 Hz and above 5000 Hz with a peak-to-average ratio of 6 dB).

<sup>3</sup>The graph of maximum input power (Fig. 11) indicates, at each frequency, the maximum continuous electrical input before 1) the systems thermal ratings are exceeded, or 2) mechanical ratings such as maximum woofer excursion are exceeded, whichever occurs first. The system can handle short term (less than 10 ms) peaks of some 8-10 dB above the indicated values as long as the long term average remains below the curve. If appreciable subsonic energy below 15 Hz is expected in the program material, second-order or higher high-pass filtering should be used ahead of the power amplifier.

<sup>4</sup>The individual rating for each portion of the system in the biamp mode is the same as the ratings shown in Fig. 11 in the corresponding frequency range above and below 1000 Hz.

<sup>5</sup>SPL in dB ref 20 μPa. These SPLs are measured in the reverberant field of a reference room of 85 m<sup>3</sup> (3000 ft<sup>3</sup>) with an absorption of 18.6 metric Sabins (200 ft<sup>2</sup>). The continuous program maximum SPL is based on the noise spectrum and powers listed in the specification for maximum continuous program power input (see note 2). The graph of maximum continuous sine wave SPL (Fig. 12) shows the maximum SPL the system can generate at each frequency when the input levels of Fig. 11 are applied.

<sup>6</sup>A special crossover card is available for JBL electronic frequency dividing networks which will provide the appropriate crossover characteristics for bi-amplification. If another electronic network is used, a 12 dB/octave filter slope will provide the closest approximation.

### References

- [a] P. Garde, "All-Pass Crossover Systems," *J. Audio Eng. Soc.*, vol. 28, pp. 575-584 (Sept. 1980).  
 [b] J. Blauert, P. Laws, "Group Delay Distortions in Electroacoustical Systems," *J. Acoust. Soc. Am.*, vol. 63, pp. 1478-1483 (May 1978).  
 [c] H. Suzuki, S. Morita, T. Shindo, "On the Perception of Phase Distortion," *J. Audio Eng. Soc.*, vol. 28, pp. 570-574 (Sept. 1980).  
 [d] R. Lee, "Is Linear Phase Worthwhile," presented at the 68th Convention of the Audio Eng. Soc., Preprint 1732 (F-4), (Mar. 1981).

JBL continually engages in research related to product improvement. New materials, production methods, and design refinements are introduced into existing products without notice as a routine expression of that philosophy. For this reason, any current JBL product may differ in some respect from its published description but will always equal or exceed the original design specifications unless otherwise stated.

Figure 2. Beamwidth (-6 dB) vs. Frequency (4430)

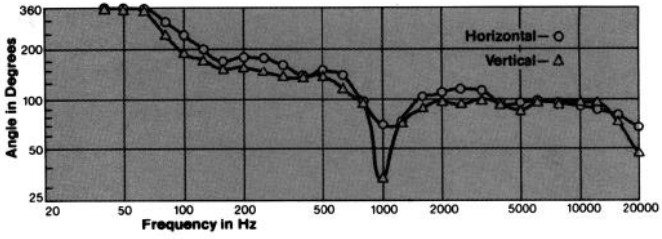

Figure 3. Directivity vs. Frequency (4430)

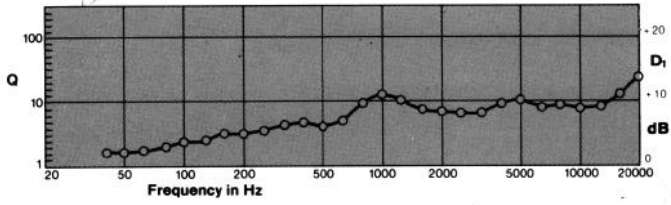

Figure 4. Horizontal Off-axis Response

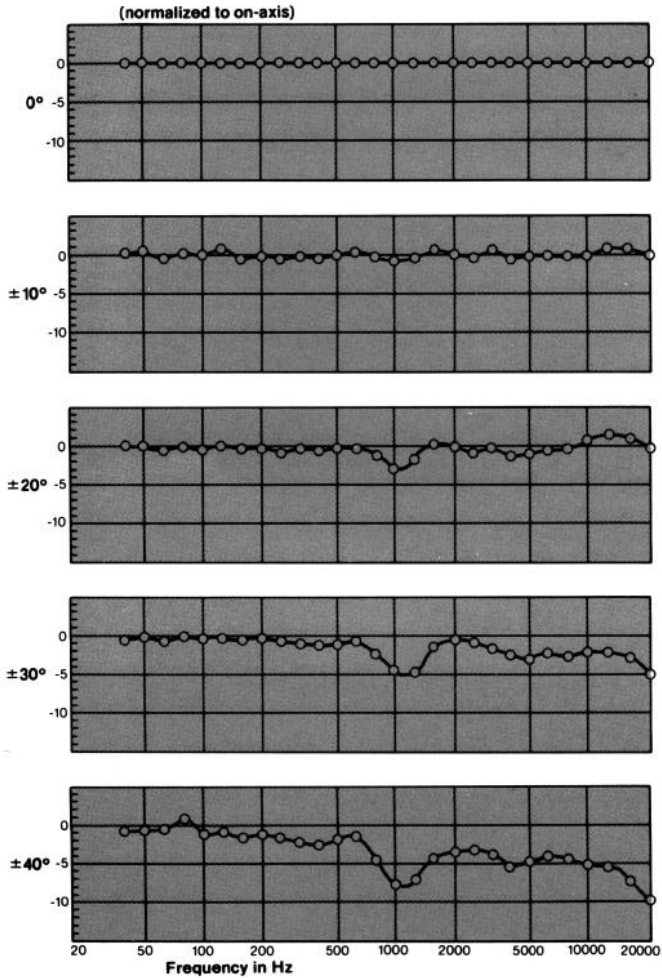

Figure 5. Vertical Off-axis Response (normalize to on-axis)

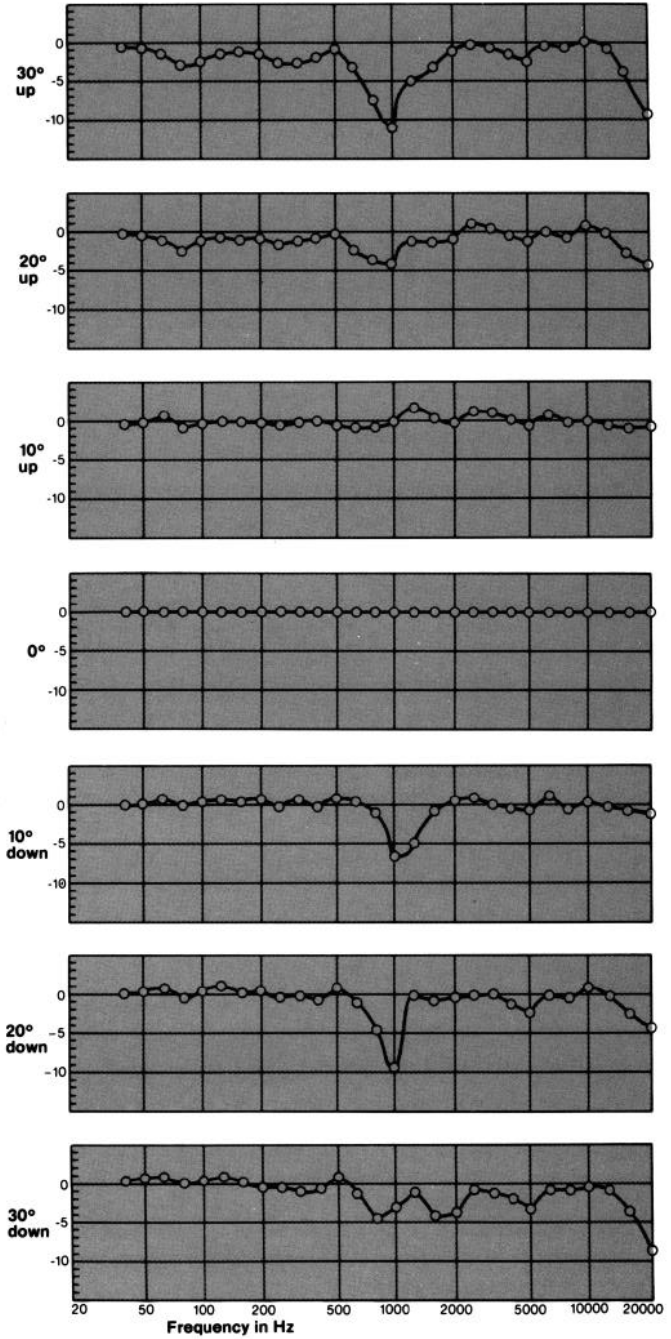

Figure 6. Group Delay vs. Blauert & Laws Criteria

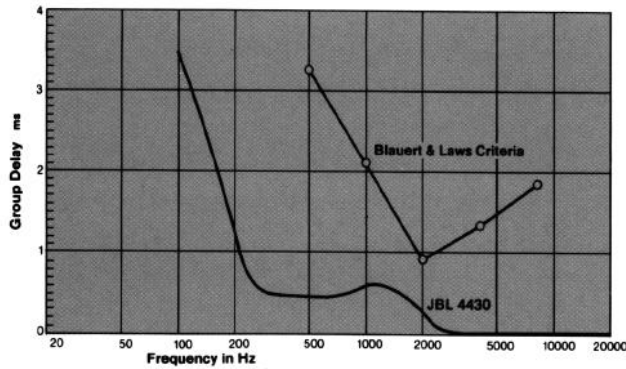

Figure 7. Control Range, Mid (4430)

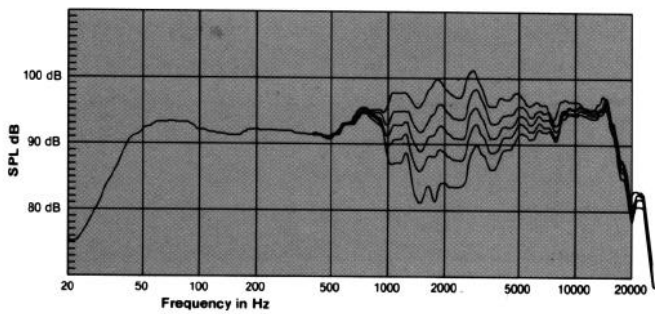

Figure 8. Control Range, High (4430)

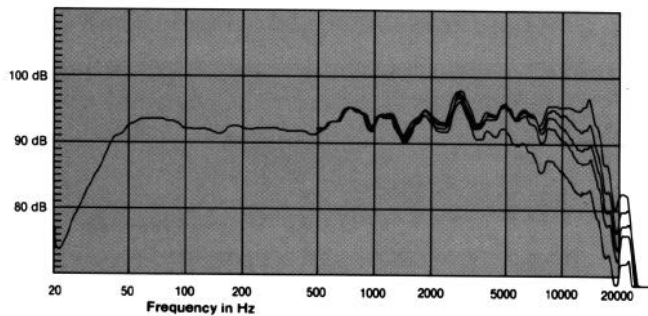

Figure 9. Impedance (4430)

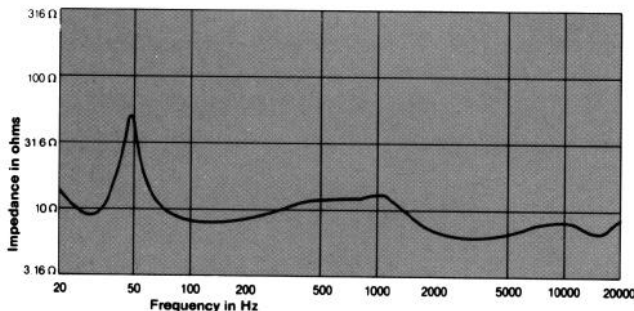

Figure 10. Impedance (4435)

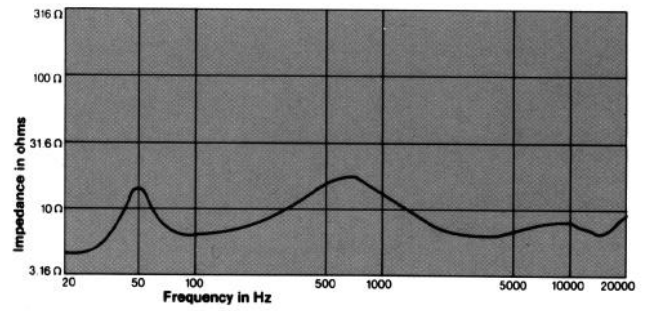

Figure 11. Maximum Electrical Input

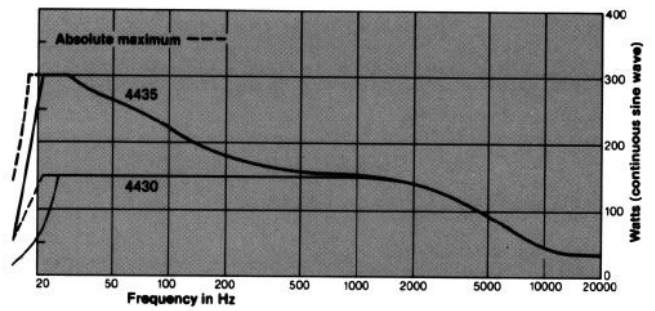

Figure 12. Maximum Continuous Output

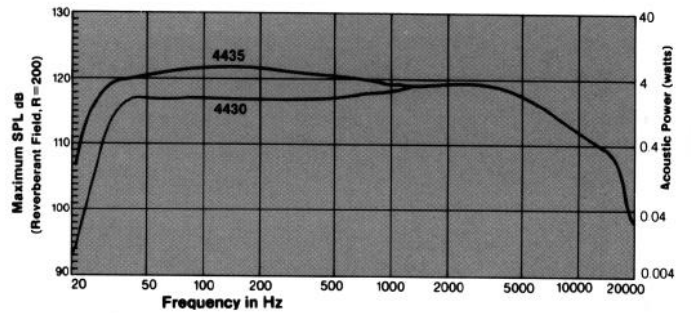
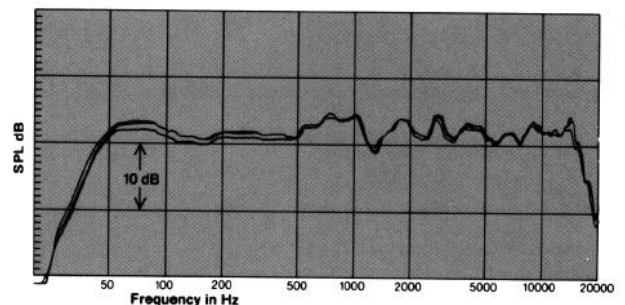

Figure 13. Power Linearity (4430), 1 W, 10 W, 100 W @ 1 m: (Average Axial Level of 93 dB, 103 dB, 113 dB SPL)



# ► 4430, 4435 Bi-Radial® Studio Monitors

Figure 14. Power Linearity (4435), 1 W, 10 W, 100 W @ 1 m: (Average Axial Level of 96 dB, 106 dB, 116 dB)

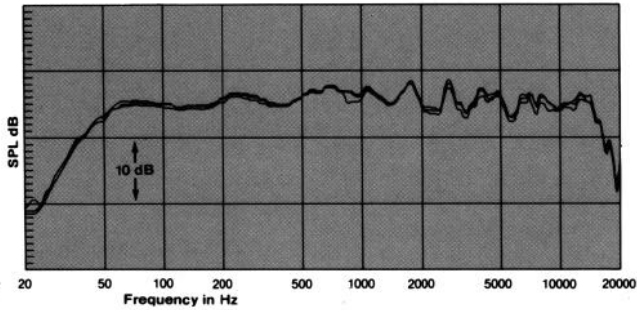

Figure 15. Distortion vs. Frequency (4430)

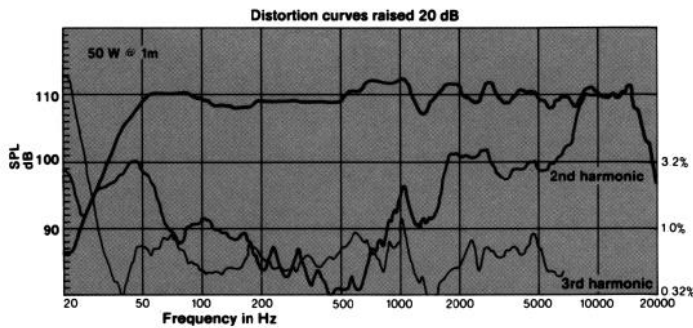
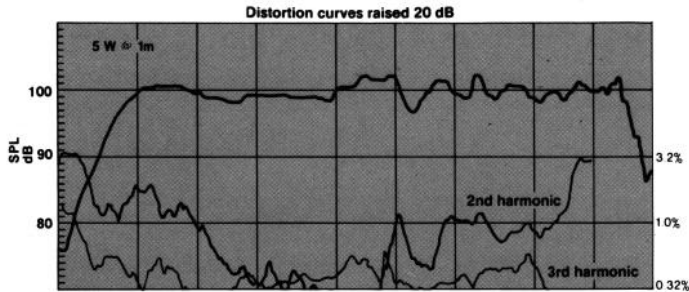
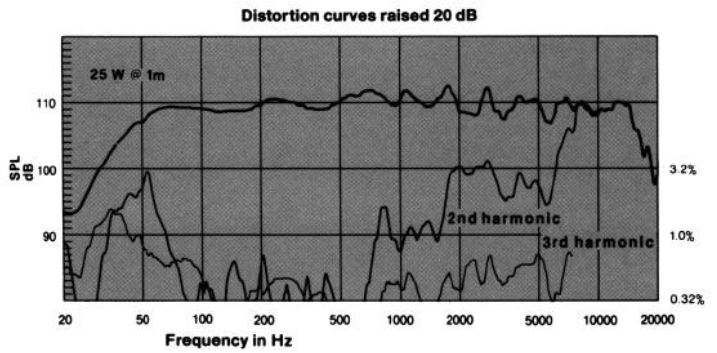
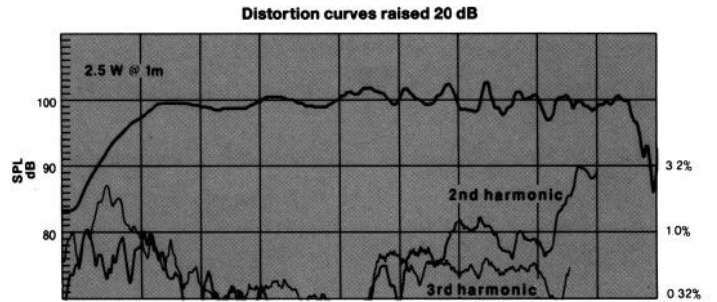

Figure 16. Distortion vs. Frequency (4435)



JBL Professional  
 8500 Balboa Boulevard, P.O. Box 2200  
 Northridge, California 91329 U.S.A.  
 A Harman International Company

SS4430/35  
 CRP 5M  
 9/95