

JBL**PROFESSIONAL**
by **HARMAN**

JBL PROFESSIONAL

JBL is the largest brand within Harman. JBL's home base is part of the Harman International Business Campus, located in Northridge in the San Fernando Valley of Los Angeles. The 44 acre site comprises the offices of JBL Professional, along with Harman Corporate Engineering activities and other corporate functions.

JBL Professional's transducer design and manufacturing processes including machining, diaphragm forming, wire milling, voice coil winding, finishing, assembly and testing are all carried out by dedicated, quality-oriented personnel.

JBL Professional loudspeaker enclosures are constructed from components produced in JBL's extensive wood mill. Automated equipment is used extensively for uniformity and efficiency. Innovative techniques in enclosure materials, construction and assembly methods are employed.

JBL Professional has the most rigorous standards for system power rating in the professional loudspeaker industry. Power testing of transducers is an ongoing activity at JBL Professional. Samples from all production lots are tested at full rated power to industry standards to ensure that they meet the rigid performance specifications set for them. This is the professional customer's assurance that JBL loudspeakers will continue to perform as expected in the most rigorous professional applications.

PORTABLE PRODUCTS**TOUR SOUND PRODUCTS****INSTALLATION PRODUCTS****COMMERCIAL SOUND PRODUCTS****STUDIO MONITORS****CINEMA LOUDSPEAKER SYSTEMS****LOUDSPEAKER COMPONENTS**



EON 600 SERIES



The next step forward in Portable PA technology.

JBL introduced the EON line in 1995, setting the standard for a powered, portable PA that sounded great in a wide variety of applications. The EON 600 Series has been totally redesigned to be more usable, durable, and controllable than ever before. Right away, users will notice the blacked out hardware and a redesigned, road-tough enclosure that allows the speakers to be used in any setting. JBL's patented Image Control Waveguide™ and Pattern Control Aperture™ ensure wide even dispersion across the frequency range. Finally, the Bluetooth app allows the user unprecedented control in a portable, reliable PA system.

- 1000 watt high performance Class-D amplifier technology
- JBL Designed Transducers
- 1" JBL annular polymer diaphragm, neodymium compression driver
- Professional looking, utility-driven cabinet design
- Road tough enclosure with baffles protecting the grille and the back panel
- JBL Image Control Waveguide and Pattern Control Aperture deliver uniform coverage and high intelligibility throughout the entire coverage area
- 4 application based EQ presets - Main, Monitor, Speech and for use with a Subwoofer
- 2 XLR-1/4" combination inputs with level control, XLR loop-through
- iOS and Android app for system control via Bluetooth
- 3 M10 fly points on each model

EON 600 SERIES
PORTABLE PRODUCTS





EON610

TWO-WAY 10" POWERED LOUDSPEAKER SYSTEM

The EON610 is a lightweight loudspeaker system capable of full bandwidth sound reproduction at high levels. Weighing only 26 lbs, the EON610 is a fantastic solution when high quality sound is needed in many varying applications. With the Bluetooth app, the speakers can be optimized for use in various settings, and users can recall those settings instantly the next time around.

- 124 dB peak SPL
- 10" JBL low-frequency driver for low distortion and higher SPL
- 52 Hz-20 kHz frequency response
- 26 lbs



EON612

TWO-WAY 12" POWERED LOUDSPEAKER SYSTEM

The EON612 is a multipurpose self-powered sound reinforcement speaker that is perfect for monitoring, side fills, and speech reinforcement. With four application presets that are available right from the back panel, the EON612 allows users to deploy the product wherever high quality sound is needed.

- 126 dB peak SPL
- 12" JBL low-frequency driver for low distortion and higher SPL
- 48 Hz-20 kHz frequency response
- Low frequency pattern control aperture for excellent off-axis low frequency response
- 33 lbs



EON615

TWO-WAY 15" POWERED LOUDSPEAKER SYSTEM

The EON615 is a powerful portable loudspeaker that delivers high performance sound reinforcement in an acoustically optimized, durable enclosure. Perfect for performing musicians, DJs, Houses of Worship, clubs, and so many others, the EON615 represents the next step forward in portable loudspeaker technology.



- 127 dB peak SPL
- 15" JBL low-frequency driver for low distortion and higher SPL
- 39 Hz-20 kHz frequency response
- Low frequency pattern control aperture for excellent off-axis low frequency response
- 39 lbs



EON 206P

Lightweight, go anywhere packaged PA.

The EON 206P is a portable PA that offers JBL's proven sound quality in an easy to carry package that goes everywhere sound reinforcement is needed. The suitcase style enclosure snaps apart, revealing two two-way speakers and a powered, 6-channel mixer, as well as the necessary cables to plug it in and set it up. Intuitive controls allow users to dial in the perfect mix for live performance, public speaking, classroom settings, and music playback. Weighing only 25 lbs, the EON206P is extremely easy to transport, and its road tough enclosure ensures years of usage in the most demanding conditions.

- 1" neodymium high frequency tweeter
- 6.5" low-frequency driver for low distortion and higher SPL
- Standard 35mm pole sockets fit professional speaker poles
- 100 degree horizontal by 80 degree vertical coverage pattern for best in class coverage
- 160 watt, 6-channel powered mixer

POWERED MIXER INPUT PANEL



The attached mixer has 6 inputs: The 2 mono inputs are comprised of a combination input connector, MIC/LINE selector, Treble and Bass controls, Reverb, and channel volume controls. The 4 stereo inputs are where you can connect musical instruments and external sound sources (like MP3 or CD players). The stereo inputs labeled "CH 3/4" offer the option of using RCA or 1/4 and include a volume control. The input labeled "CH5/6" is a 3.5 mm stereo input of the type typically found on personal music players. The "Monitor Out" enables sourcing to recording devices, additional powered speakers, or mixers via RCA connectors.

EON PACKAGED
PORTABLE PRODUCTS





PRX700 SERIES

POWERFUL. SCALABLE. VERSATILE.

For portable and install applications

The PRX700 Series represent an evolutionary step in the efficient use of amplifier power, rugged durability, and enhanced versatility in a self-powered loudspeaker. PRX700 has been designed from the ground up to perform in the real world of sound reinforcement where challenging audio environments, high ambient noise levels and loud volumes are typical. They are the first systems to use our patented Differential Drive technology with ferrite magnets featuring high power, wide bandwidth and low distortion. Versatile, scalable, easy-to-transport and setup, the PRX700 Series are built on JBL's tour tested technology for a lifetime of reliable performance you can trust.



TOUR TESTED FOR A LIFETIME OF RELIABLE PERFORMANCE

- 1500 watt high performance Class-D amplifier technology
- JBL Differential Drive woofers
- DSP input section with crossover, dynamic limiting, and component optimization
- User selectable system EQ
- XLR-1/4" combination inputs, RCA inputs, and XLR loop-through
- Lightweight poplar plywood cabinets protected by JBL's rugged DuraFlex finish
- Integrated M10 suspension points for easy installation and setup
- 1.5" neodymium high frequency compression drivers

PRX700 SERIES
PORTABLE PRODUCTS





PRX710

10" POWERED TWO-WAY SPEAKER SYSTEM

PRX710 is the most compact and versatile speaker in the series. Designed to deliver maximum performance for its weight and size as a front of house main PA, The PRX710 is a perfect match with the PRX715XLF series subwoofer, offering a high performance self-powered sub/sat system.

- 100° x 60° nominal coverage pattern
- 133 dB peak SPL
- 43 Hz-20 kHz frequency response
- 36 lbs



PRX712

12" POWERED TWO-WAY MAIN/FLOOR MONITOR SYSTEM

PRX712 is compact and versatile. It has been designed to deliver maximum performance as both a stage monitor and a front of house main PA. The PRX712 is a perfect match with a PRX715XLF or PRX718XLF subwoofer, offering a high performance self-powered sub/sat system.

- 90° x 50° nominal coverage pattern
- 135 dB peak SPL
- 45 Hz-19.5 kHz frequency response
- 42.5 lbs



PRX715

15" POWERED TWO-WAY MAIN/FLOOR MONITOR SYSTEM

PRX715 offers the perfect balance between size and performance. Its asymmetrical design makes this a perfect choice for musicians, entertainers and DJs when portability is key, or when hung by the suspension points, an exceptional light-duty installation speaker. It is also a perfect match with the PRX715XLF or PRX718XLF subwoofer for a high performance full-range sound system.

- 90° x 50° nominal coverage pattern
- 136 dB peak SPL
- 43 Hz-19.5 kHz frequency response
- 47.5 lbs



PRX725

DUAL 15" POWERED TWO-WAY MAIN SYSTEM

PRX725 is an optimal solution when simple setup and full bandwidth output at high levels are required. The dual 15" woofer design creates enough low frequency content to serve most live music or music playback situations. When coupled with a PRX718XLF the system becomes a high volume sound reinforcement solution, perfect for regional tour companies and AV Rental companies looking for a scalable, easy to employ audio solution.

- 90° x 50° nominal coverage pattern
- 139 dB peak SPL
- 40 Hz-18.5 kHz frequency response
- 82 lbs



PRX735

15" POWERED THREE-WAY MAIN SYSTEM

PRX735 is ideally suited to applications where the program material exhibits subtlety and nuance. Perfectly capable of reproducing high fidelity full range sound, when coupled with the extended low frequencies of the PRX718XLF, complete control over the entire audio spectrum is attained.

- 90° x 50° nominal coverage pattern
- 136 dB peak SPL
- 34 Hz-20 kHz frequency response
- 77 lbs



PRX715XLF

15" POWERED EXTENDED LOW FREQUENCY SUBWOOFER SYSTEM

PRX715XLF is an extended low frequency compact subwoofer designed and engineered to provide sub bass frequencies with accuracy and power. Used as a single sub in a sub/sat system or in multiples as part of a scalable large format sound system, the PRX715XLF performs with exceptional efficiency and control.

- 2 x XLR-1/4" combination inputs with 2 x XLR loop-thru
- Integrated stereo pass-thru with selectable HP filter and polarity reverse
- Integrated M20 threaded pole receptacle
- 131 dB peak SPL
- 37 Hz-113 Hz frequency response
- 56 lbs



PRX718XLF

18" POWERED EXTENDED LOW FREQUENCY SUBWOOFER SYSTEM

PRX718XLF is an extended low frequency subwoofer designed and engineered to provide sub bass frequencies with accuracy and power. Used as a single sub in a sub/sat system or in multiples as part of a scalable large format sound system, the PRX718XLF performs with exceptional efficiency and control.

- 2 x XLR-1/4" combination inputs with 2 x XLR loop-thru
- Integrated stereo pass-thru with selectable HP filter and polarity reverse
- Integrated M20 threaded pole receptacle
- 134 dB peak SPL
- 30 Hz-103 Hz frequency response
- 81 lbs



JRX200 SERIES

AFFORDABLE, RELIABLE, HIGH QUALITY SOUND

JRX200 delivers the performance and prestige JBL is known for at an affordable price point. These speaker systems have been stripped down to the bare essentials of high quality sound, allowing JBL to offer a system with a popular price point and proven JBL performance.

JRX200 SERIES
PORTABLE PRODUCTS



JRX212

TWO-WAY 12" PASSIVE LOUDSPEAKER SYSTEM

The JRX212 is a compact and low profile stage monitor with optimized performance in the critical mid-range. It also includes JBL's dual angle pole socket for use as a front-of-house speaker

- 250 watt passive system with 1000 watt peak power rating
- Includes monitor angle and dual angle 35mm pole socket
- 128 dB peak SPL
- 60 Hz-20 kHz frequency response
- 43 lbs



JRX215

TWO-WAY 15" PASSIVE LOUDSPEAKER SYSTEM

The JRX215 is a trapezoidal 15" speaker system for use in live sound, dance music, and speech reinforcement. The speaker includes a dual-angle 35mm pole mount socket.

- 250 watt passive system with 1000 watt peak power rating
- Includes dual angle 35mm pole mount socket
- 129 dB peak SPL
- 41 Hz-18 kHz frequency response
- 60.5 lbs



JRX225

TWO-WAY DUAL 15" PASSIVE LOUDSPEAKER SYSTEM

The JRX225 is a portable dual 15" two-way speaker system designed specifically for applications in live music performance and playback.

- 500 watt passive system with 2000 watt peak power rating
- 133 dB peak SPL
- 42 Hz-18 kHz frequency response
- 94 lbs



JRX218S

18" PASSIVE SUBWOOFER SYSTEM

The JRX218S subwoofer is driven by a massive JBL 18" woofer with a cast frame. A top mounted cast aluminum 36mm pole mount receptacle facilitates the use of the JRX218S as a base for a mid-high speaker cabinet.

- 350 watt passive system with 1400 watt peak power rating
- 133 dB peak SPL
- 34 Hz-25 Hz frequency response
- 71 lbs



Left: Built in dual-angle pole mount sockets on PRX412M and PRX415M.
Right: Twelve built-in M10 suspension points.



PRX400 SERIES

AFFORDABLE, PROFESSIONAL PERFORMANCE

PRX400 passive speakers were designed to provide the sensitivity, frequency response and power handling needed for almost any professional audio environment while still being reasonably priced. Whether you use a powered mixer or an equipment rack full of amps and signal processing, PRX400 passive speakers deliver the sound, power and bandwidth necessary to make loud music sound natural and even quiet speech intelligible. Utilizing poplar and birch enclosures as well as JBL's rugged DuraFlex coating, these speakers are road tough and ready to perform in any environment.



PRX412M

TWO-WAY 12" PASSIVE LOUDSPEAKER SYSTEM

Used as either a high performance satellite speaker or a stage monitor, the PRX412M is a fantastic, versatile system for a variety of applications. Features the dual angle pole mount allowing it to be mounted vertically or with a 10 degree down tilt.

- 300 watt passive system with 1200 watt peak power rating
- Includes M10 suspension points for easy rigging and available in white
- 126 dB peak SPL
- 50 Hz-20 kHz frequency response
- 35 lbs



PRX415M

TWO-WAY 15" PASSIVE LOUDSPEAKER SYSTEM

Used as either a high performance satellite speaker or a stage monitor, the PRX415 delivers excellent clarity and fidelity in even the most demanding sound reinforcement applications. Features the dual angle pole mount allowing for it to be mounted vertically or with a 10 degree down tilt.

- 300 watt passive system with 1200 watt peak power rating
- Includes M10 suspension points for easy rigging and available in white
- 129 dB peak SPL
- 55 Hz-19 kHz frequency response
- 46 lbs



PRX425

TWO-WAY DUAL 15" PASSIVE LOUDSPEAKER SYSTEM

An excellent choice when the application calls for high performance and simplicity. A pair of PRX425s is a complete sound system capable of reproducing bass and kick drum or playing high-level music in clubs.

- 600 watt passive system with 2400 watt peak power rating
- 90(H) x 50(V) waveguide for uniform audience coverage
- 134 dB peak SPL
- 48 Hz-19 kHz frequency response
- 74 lbs



PRX418S

18" PASSIVE SUBWOOFER SYSTEM

Compact, high power subwoofer system containing a JBL Selenium 18" woofer in a front loaded vented enclosure. When combined with the PRX400 two-way models, it provides a sub/sat system capable of generating 135dB of full-range, high quality audio.

- 800 watt passive system with 3200 watt peak power rating
- 130 dB peak SPL
- 35 Hz-250 Hz frequency response
- 79 lbs



STX800[®] SERIES

HIGH PERFORMANCE, HIGH DENSITY SYSTEM SOLUTION

Total Performance

The STX800 Series embodies the Total Performance principle that drives JBL's development of audio products that make a real difference in the world of professional audio. Their superb sonic performance is based on time tested JBL technology: high power handling transducers that deliver extremely low distortion, precision waveguides for exact pattern control, and intelligent cabinet architecture that is engineered for easy handling, minimal space displacement and rugged transport. And the appearance was sculpted to complement our high end VTX touring systems as well as our current PRX portable offerings. STX is V5 compliant with tunings available in Performance Manager and Crown ITHD power amplifiers.

DESIGNED WITH TIME TESTED JBL TECHNOLOGY

- Four full-range systems and two subwoofers
- High performance, high density system solution in a truck-pack friendly format
- High power handling transducers that deliver extremely low distortion
- Precision waveguides for exact pattern control
- All enclosures built with top quality birch/poplar plywood
- Compatible with Crown VRack and V5 level processing
- Integrated into JBL HiQnet Performance Manager

STX800 SERIES
PORTABLE PRODUCTS

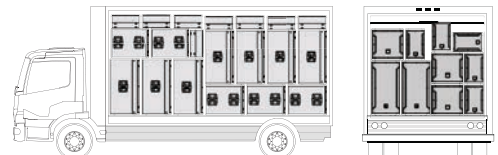

TRUCK PACK FRIENDLY

All STX800 Series cabinets were sized in an effort to maximize the interior compartments of most standard transport vehicles. Considerations were made to help STX owners exploit the given area in an effort to reduce fuel costs by eliminating additional vehicles or extra trips.



STX812M

12" TWO-WAY STAGE MONITOR

Designed specifically to be a high performance 12" two-way floor monitor, can also do double duty as a utility speaker for use on a tripod stand or over a subwoofer, utilizing a single-position pole mount. A 70° by 70° waveguide is utilized for precise coverage.

- 800 watt continuous power rating at 8 ohms
- 3" neodymium magnet compression driver
- 130 dB peak SPL
- 50 Hz-20 kHz frequency response



STX815M

15" TWO-WAY SYSTEM

Single 15" lightweight two-way system designed as a high power handling, Front of House loudspeaker system or as an extended range floor monitor. Offers an extremely high level of performance either ground, pole or stand mounted.

- 800 watt continuous power rating at 8 ohms
- 3" neodymium magnet compression driver
- 131 dB peak SPL
- 41 Hz-20 kHz frequency response



STX825

DUAL 15" TWO-WAY SYSTEM

Designed for maximum impact, portability and ease of use. With a wide frequency range and broad 90° x 50° coverage, this speaker is ideal for bands or DJs as their primary PA, use as a side-fill on a concert stage, or as an install speaker in a dance club or performance venue.

- 1600 watt continuous power rating at 4 ohms
- 4" neodymium magnet compression driver
- 136 dB peak SPL
- 34 Hz-20 kHz frequency response



STX835

DUAL 15" THREE-WAY SYSTEM

Slot-loaded dual 15" three-way system with horn-loaded mid and high sections, designed for full-range use in stand-alone applications or for use in high performance environments as the premier ground stack passive top box. The 60° x 40° mid and high frequency waveguides allow two cabinets to be splayed for wide angle coverage.

- 1600 watt continuous power rating at 4 ohms
- Cone Midrange Compression Driver provides low midrange distortion, increased sensitivity and extended bandwidth
- 134 dB peak SPL
- 32 Hz-20 kHz frequency response



STX818S

SINGLE 18" COMPACT SUBWOOFER SYSTEM

Front-loaded, vented enclosure designed for minimum frontal area provides 1,000 watt of continuous pink noise power handling and 4kW peak. Comes equipped with a top-mounted M20 pole-mount and an optional wheel kit.

- 1000 watt continuous power rating at 8 ohms
- Large port area for reduced distortion
- 132 dB peak SPL
- 40 Hz-120 Hz frequency response



STX828S

DUAL 18" HIGH POWER SUBWOOFER SYSTEM

Front-loaded, vented enclosure designed for maximum low-frequency performance. Two drivers give 2,000 watts of continuous pink noise power handling with 8kW peak. Optional wheel kit.

- 2000 watt continuous power rating at 4 ohms
- Dual 18" Super Vented Gap woofers for extended low frequency output
- 138 dB peak SPL
- 37 Hz-120 Hz frequency response

VRX900 SERIES
PORTABLE PRODUCTS



VRX932LA-1
(3 shown)
VRX932LAP



VRX928LA
(2 shown)



VRX915S

VRX900 SERIES

HIGH PERFORMANCE CONSTANT CURVATURE LINE ARRAY

Extraordinary power handling, clarity and flexibility

The VRX Series addresses the growing need for a small format professional sound system for sound rental companies, fixed installations and musicians looking for the ultimate in performance and portability. Sharing components with the JBL VERTEC Series, the VRX series features the performance of high end line arrays in a compact format. Its affordable and flexible and provides outstanding coverage and output coherence, while delivering extraordinary power handling, clarity and flexibility.

STUNNING, LEGENDARY JBL SOUND

- Constant curvature line array system for an easy to use controlled, coherent coverage pattern
- High performance, lightweight neodymium Differential Drive Woofers
- Powered by high performance, ultra-compact Crown Class-D amplification
- Simplified rigging and quick connections ensure fast setup and takedown
- Constructed with premium birch plywood and coated in JBL's rugged DuraFlex finish
- VRX Array Tool available for the user to understand and properly deploy the array



VRX918S
VRX918SP

VRX915M

VRX915M

15" TWO-WAY FLOOR MONITOR

Dedicated, compact and lightweight 15" two-way touring class floor monitor using JBL's latest neodymium transducers.

- 800 watt continuous power rating at 8 ohms
- 50° x 90° nominal coverage
- 4" neodymium magnet compression driver

VRX928LA

8" TWO-WAY COMPACT LINE ARRAY SPEAKER SYSTEM

Lightweight compact 8" two-way line array speaker system designed for use in arrays of up to six units. The ideal choice when line array performance is needed but the venue size doesn't call for the very long-throw characteristics of the larger VRX932LA.

- 400 watt continuous power rating at 8 ohms
- Includes switches for amplitude shading on each enclosure
- Available in white

VRX932LA-1

12" TWO-WAY COMPACT LINE ARRAY SPEAKER SYSTEM

Lightweight compact 12" two-way line array speaker system designed for use in arrays of up to six units. VRX932LA-1 can be suspended in a single array for nominal vertical coverage up to 90 degrees or used on a pole over subwoofers.

- 800 watt continuous power rating at 8 ohms
- Includes switches for amplitude shading on each enclosure
- Available in white

VRX932LAP

12" POWERED TWO-WAY COMPACT LINE ARRAY SYSTEM

Powered lightweight 12" two-way line array system designed for use in arrays of up to five units. Can be suspended in a single array for nominal vertical coverage up to 75 degrees or used on a pole over subwoofers.

- Powered by JBL DPC-2 amplifier module designed by Crown
- Includes rigging hardware for simple connection and dual angle pole socket
- Includes switches for amplitude shading on each enclosure

VRX915S

15" COMPACT HIGH POWER SUSPENDABLE SUBWOOFER

Compact, high power suspendable subwoofer system containing a 15" neodymium Differential Drive woofer in a front loaded, vented enclosure.

- 800 watt continuous power rating at 4 ohms
- Includes rigging hardware and M20 threaded pole socket
- Available in white

VRX918S

18" COMPACT HIGH POWER SUSPENDABLE SUBWOOFER

Compact high power suspendable subwoofer system using an 18" Differential Drive woofer in a front-loaded, vented enclosure. For applications requiring the sonic and practical advantages of integrating the subwoofers into the flying array.

- 800 watt continuous power rating at 8 ohms
- Includes rigging hardware and M20 threaded pole socket
- Available in white

VRX918SP

18" POWERED HIGH POWER SUSPENDABLE SUBWOOFER

Powered, suspendable subwoofer system containing a neodymium 18" Differential Drive woofer in a front-loaded, vented enclosure. Designed specifically for use in arrays with the VRX932LAP line array speaker. Equally at home in ground stacked applications.

- Powered by JBL DPC-2 amplifier module designed by Crown
- Includes rigging hardware and M20 threaded pole socket
- Large port area for reduced distortion



JBL VTX System :
 Lakewood Church in Houston, Texas
 Includes 60) JBL VTX V25 line array cabinets and
 20) VTX S28 subwoofers, flown in six arrays
 Audio Contractor: Covenant Communications

VTX SERIES



VTX SERIES
TOUR SOUND PRODUCTS

NEXT GENERATION LINE ARRAY SYSTEM SOLUTIONS



Of all the achievements JBL has made over the years, the VTX Series stands as a milestone in the practical application of creative engineering. The next generation in line arrays, VTX heralds a new era in performance, system integration and user friendliness.

Featuring multiple patents in driver, waveguide and suspension technology, VTX is also supported by technologies from Harman Professional sister companies for amplification, DSP, control and system management. In addition to high performance components, VTX is backed by JBL's high performance engineering support - the human factor and technical tools that are key to the proper specification and configuration of the VTX system in any venue, anywhere in the world.

The VTX Series is a result of JBL's continued effort to deliver more powerful, more compact, lightweight and flexible sound reinforcement systems. Designed for portable and fixed-venue system operators alike, VTX features JBL's legendary sound quality coupled with the most advanced sound reinforcement technology and support available.

D2 Dual Diaphragm Dual Voice Coil Compression Driver

Dramatically improves the sound and performance of high frequencies by overcoming the limitations of conventional compression driver technology. By merging two annular, polymer diaphragms into a single compact transducer, the D2 driver has the same radiating area as a conventional device with increased power handling/output, extended HF response and reduced distortion.



Next Generation Waveguide Technology

VTX V20 and V25 feature 3rd and 4th generation HF waveguide technology that produces a coherent, time-aligned high frequency wavefront that maximizes the combined output of three D2 Dual Drivers. The cast-aluminum waveguide creates a wavefront that is sufficiently flat to couple properly at extreme high frequencies and the active radiating surface area extends to the edge of the enclosure optimized line source array coupling from 0-12.5 degrees (V20) and 0-10 degrees (V25).

New Multi-Mode ASM Suspension

VTX V20 and V25 introduce new and highly versatile ASM suspension systems that enable arrays to be deployed quickly and accurately in a wide variety of applications. Able to be deployed in compression mode or in fixed angle mode, the new ASM suspension systems enable faster setup with fewer pinning operations and all suspension hardware is integrated into the enclosure.



VTX SERIES

COMPLETE SYSTEM INTEGRATION AND SUPPORT



With the VTX Series you are not just using a product, you are gaining access to an expert system. Tools for system design and all the components to analyze, configure, set up and control a VTX system are all part of the JBL commitment to total system integration and support. The goal is maximum efficiency and the highest possible level of performance in any venue, anywhere in the world. Visit VTX on JBLPro.com to learn more about the Crown® Audio VRack, JBL Line Array Calculator and JBL HiQnet Performance Manager™ software.



VTX V25

FULL SIZE 3-WAY HIGH DIRECTIVITY LINE ARRAY ELEMENT WITH D2 DUAL DRIVERS
Fullsize 3-way line array element featuring patented D2 dual diaphragm dual driver technology and patented Differential Drive® LF and MF cone transducers.

- Revolutionary D2 Driver
- JBL's patented RBI Radiation Boundary Integrator
- 3rd Generation HF waveguide technology



VTX S28

FULL SIZE DUAL 18" SUBWOOFER WITH ULTRA LONG EXCURSION TRANSDUCERS
Suspendable, trapezoidal dual 18" cardioid-arrayable subwoofer featuring ultra long throw, patented Differential Drive® transducers configured in a front-loaded alignment with a large area, laminar-flow, low-turbulence central port.

- 2 x 2269H JBL Differential Drive 18" woofers
- High peak-to-peak excursion capability
- Reverse cardioid-arrayable



VTX G28

FULL SIZE DUAL 18" SUBWOOFER WITH ULTRA LONG EXCURSION TRANSDUCERS
Dual 18" cardioid-arrayable subwoofer with rectangular form factor for convenient ground-stacking. Ultra long throw Differential Drive® transducers are configured with inverted woofers (motors out) for improved cooling and reduced power compression.

- 2 x 2269H JBL Differential Drive 18" woofers
- High peak-to-peak excursion capability
- Reverse cardioid-arrayable



VTX V20

MIDSIZE 3-WAY HIGH DIRECTIVITY LINE ARRAY ELEMENT WITH D2 DUAL DRIVERS
Midsize 3-way line array element featuring patented D2 dual diaphragm dual driver technology with ultra-linear midrange transducers and patented Differential Drive® LF transducers.

- Revolutionary D2 Driver
- New dual-mode ASM suspension
- 4th Generation HF waveguide technology



VTX S25

FULL SIZE DUAL 15" SUBWOOFER WITH ULTRA LONG EXCURSION TRANSDUCERS
Suspendable dual 15" cardioid-arrayable subwoofer featuring ultra long throw, patented Differential Drive® transducers configured in a front-loaded alignment with dual large area, laminar-flow, low-turbulence central ports.

- 2 x 2267 JBL Differential Drive 15" woofers
- High peak-to-peak excursion capability
- Reverse cardioid-arrayable

VTX SERIES
TOUR SOUND PRODUCTS





VTX F SERIES

STUDIO MONITOR SOUND QUALITY IN A POINT-AND-SHOOT FILL ENCLOSURE

VTX F SERIES delivers studio monitor sound quality in a line of premium two-way multipurpose cabinets featuring point and shoot flexibility, uncompromised sound quality and the patented D2 Dual Diaphragm Dual Driver used in the VTX V25 and M2 Studio Reference Monitor. Ideal for point-and-shoot fill, F12 and F15 are a perfect sound design complement to VTX V25 due to the sonic consistency provided by common large format D2 driver technology. When paired with the F18S subwoofer, F12 and F15 provide a premium-quality, compact Front-of-House or Sidefill Monitoring solution and with their clean lines, F-Series is perfectly suited to demanding tour sound stage monitoring requirements. Standard pole mount socket, M10 mount points and an optional U-bracket accessory allow VTX F Series to be used in a wide variety of distributed fill applications – you name it – F Series is a versatile sound design tool.

VTX F SERIES
TOUR SOUND PRODUCTS



VTX F12

TWO-WAY 12" LOUDSPEAKER SYSTEM WITH D2 DRIVER

The VTX F12 is a two-way loudspeaker enclosure that features a high-power Differential Drive 2262H 12" woofer and a D2430K dual-diaphragm dual voice coil compression driver .

- D2430K Large Format D2 Dual Diaphragm Dual Driver
- Progressive Transition Waveguide (90° x 50° coverage pattern)
- Flexible installation accessories



VTX F15

TWO-WAY 15" LOUDSPEAKER SYSTEM WITH D2 DRIVER

The VTX F15 is a two-way loudspeaker enclosure that features a high-power Differential Drive 2265H 15" woofer and a D2430K dual-diaphragm dual voice coil compression driver .

- D2430K Large Format D2 Dual Diaphragm Dual Driver
- Progressive Transition Waveguide (90° x 50° coverage pattern)
- Flexible installation accessories



VTX F18S

HIGH POWER SINGLE 18" SUBWOOFER

The VTX F18S subwoofer enclosure features a single high-power Differential Drive 2269H 18" transducer with extremely high linear excursion capability. Mount brackets included for attaching F12 or F15 for drum monitoring applications.

- JBL 2269H Differential Drive 18" woofer
- High Linear Excursion Capability (3.5" Peak-to-Peak)
- Cardioid-Arrayable (front NL4 connector)
- Perfect complement to VTX F12 and VTX F15

Separately-ordered accessories for: VTX F12, F15, F18S

VTX F12-UB Universal mount bracket for F12 including pole mount socket and stabilizer legs for ground stacking

VTX F15-UB Universal mount bracket for F15 including pole mount socket and stabilizer legs for ground stacking

JBL SS5-BK Locking hand crank extension rod for use with F12 or F15 (-UB optional) and F18S featuring patented expanding mandrel

JBL POLE-MA Manual adjustable extension rod for use with F12 or F15 (-UB optional) and F18S

JBL POLE-GA Gas assist extension rod for use with F12 or F15 (-UB optional) and F18S

JBL TRIPOD-MA Manual adjustable tripod stand for use with F12 or F15 (-UB optional)

JBL TRIPOD-GA Gas assist tripod stand for use with F12 or F15 (-UB optional)



VTX ACCESSORIES

Separately-ordered accessories

FULLSIZE VTX ACCESSORIES

- VTX-V25-AF: Array Frame for suspending or ground stacking VTX V25 and/or VTX S28 enclosures
- VTX-V25-AF-EB: Extension bar for use with VTX-V25-AF
- VTX-V25-ACC: Accessory Kit: dolly/wheelboard and padded protective cover for one VTX V25
- VTX-S28-ACC: Accessory Kit: dolly/wheelboard and padded protective cover for one VTX S28
- VTX-G28-ACC: Accessory Kit: dolly/wheelboard and padded protective cover for one VTX G28
- VTX-V25-CS-K: Compression suspension kit to convert V25 to V25-CS
- VTX-V25-CS-K-LJ: Label jig installation fixture for use with VTX-V25-CS-K
- VTX-V25-VTC: Vertical transporter for 3 or 4 VTX V25-CS
- VTX-S28-VTC: Vertical transporter for 3 VTX S28 (front-firing or cardioid)
- VTX-V25-CVR: Padded protective cover for 3 or 4 V25-CS transported on V25-VTC
- VTX-S28-CVR: Padded protective cover for three S28 transported on S28-VTC (front-firing or cardioid)
- VTX-V25-PB: Pull Back accessory kit for suspension of VTX V25-CS arrays
- VTX-V25-LH: Manual lever hoist for compression of VTX V25-CS arrays

MIDSIZE VTX ACCESSORIES

- VTX-V20-AF: Array frame for suspending or ground stacking VTX V20 or S25 enclosures
- VTX-V20-AF-EB: Extension bar for use with VTX-V25-AF
- VTX-V20-VT: Vertical transporter for 3 or 4 VTX V20
- VTX-V20-VT-CVR: Padded protective cover for 3 or 4 VTX V20 transported on VTX-V20-VT
- VTX-S25-VT: Vertical transporter for up to 2 or 3 VTX S25
- VTX-S25-VT-CVR: Padded protective cover for 2 or 3 VTX S25 transported on VTX-S25-VT
- VTX-V20-PB: Pullback accessory kit for suspension of VTX V20 arrays in compression mode
- VTX-V20-LH: Manual lever hoist for compression of VTX V20 arrays

VTX/VERTEC LASER ACCESSORIES

- VTX-LZ-K: Laser Kit (Power supply and 2xVTX-LZ lasers)
- VTX-LZ: Laser only (1 piece)
- VTX-LZ-PS: Power supply only (1 piece)
- VTX-LZ-V25-MB: Mounting bracket for VTX-LZ to VTX V25
- VTX-LZ-V20-MB: Mounting bracket for VTX-LZ to VTX V20
- VTX-LZ-89-MB: Mounting bracket for VTX-LZ to VT4889
- VTZ-LZ-8788-MB: Mounting bracket for VTZ-LZ to VT4888 or VT4887

VERTEC SERIES

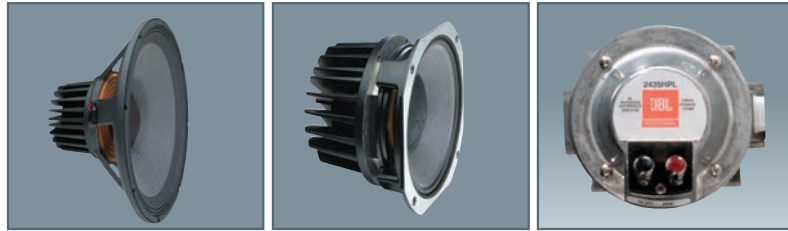

2255H 15" DIFFERENTIAL DRIVE® LOUDSPEAKER

2250H 8" MIDRANGE CONE TRANSDUCER

2435H HIGH PERFORMANCE COMPRESSION DRIVER

VT4889-1 SYSTEM COMPONENTS

VERTEC SERIES
TOUR SOUND PRODUCTS



FULLSIZE
VT4889-1

VT4889-1

FULLSIZE THREE-WAY LINE ARRAY ELEMENT

Fullsize, lightweight enclosure housing two 15" woofers, four 8" midrange transducers, and three high frequency compression drivers.



- 2000W LF, 1400W MF, 225W HF
- Includes patented Radiation Boundary Integrator
- Rigid lightweight enclosure



MIDSIZED
VT4888

VT4888

MIDSIZED THREE-WAY LINE ARRAY ELEMENT

Midsized, lightweight line array element housing two 12" woofers, four 5.25" midrange transducers, and two high frequency compression drivers.

- 2000W LF, 600W MF, 150W HF
- Includes patented Radiation Boundary Integrator
- Rigid lightweight enclosure



COMPACT
VT4887A

VT4887A

COMPACT BI-AMPED THREE-WAY LINE ARRAY ELEMENT

Compact, lightweight line array element housing two 8" woofers, four 4" midrange transducers, and two high frequency compression drivers.



- 1000W LF, 225W MF/HF
- Includes patented Radiation Boundary Integrator
- Rigid lightweight enclosure



SUBCOMPACT
VT4886

VT4886

SUBCOMPACT PASSIVE THREE-WAY LINE ARRAY ELEMENT

Subcompact passive three-way line array element fitted with two 6.5" woofers, four 2.5" midrange transducers, and two high frequency drivers with a highly refined internal passive network.



- 900W continuous power rating
- Integrated mid/high waveguide provides 110° horizontal coverage
- Highest SPL output in its class

VERTEC SERIES

SYSTEM FEATURES



PRECISION WAVEGUIDES



RBI™: RADIATION BOUNDARY INTEGRATOR



INPUT PANEL WITH PARALLEL CONNECTORS



Dual 2269H Differential Drive Woofer



VT4880
VT4880A

VT4880

FULLSIZE DUAL 18" SUBWOOFER
Fullsize, lightweight, centrally-vented arrayable subwoofer housing two 18" woofers.

- 2000 watt continuous power rating
- Dual 2258H Differential Drive woofers
- Rigid lightweight enclosure



VT4880
VT4880A

VT4880A

FULLSIZE DUAL 18" ULTRA LONG EXCURSION SUBWOOFER
Fullsize, lightweight, centrally-vented arrayable subwoofer housing two ultra long excursion 18" woofers.

- 4000 watt continuous power rating
- Dual 2269H Differential Drive woofers
- Rigid lightweight enclosure



VT4882

MIDSIZE DUAL 15" SUBWOOFER
Midsize, lightweight, centrally-vented arrayable subwoofer enclosure housing two long-excursion 15" woofers.

- 2000 watt continuous power rating
- Dual 2266H Differential Drive woofers
- Rigid lightweight enclosure



VT4881A

COMPACT 18" SUBWOOFER
Compact, lightweight, vented arrayable subwoofer enclosure housing one ultra long excursion 18" woofer.

- 2000 watt continuous power rating
- Single 2269H Differential Drive woofer
- Rigid lightweight enclosure



VT4883

SUBCOMPACT DUAL 12" CARDIOID-ARRAYABLE SUBWOOFER
Subcompact dual 12" cardioid-arrayable companion low frequency extension for the VT4886 subcompact three-way enclosure.

- 2000 watt continuous power rating
- Dual 2263H-1 Differential Drive woofers
- Rigid lightweight enclosure

VERTEC SERIES
TOUR SOUND PRODUCTS



VERTEC ACCESSORIES

Separately-ordered accessories for:
VT4889-1, VT4880, VT4880A, VT4888, VT4882, VT4887A and VT4881A

Accessory Kits

VT4889-1-ACC	Dolly/wheelboard and padded protective cover for one VT4889-1.
VT4880-ACC	Dolly/wheelboard, padded protective cover and suspension hinge bars for one VT4880.
VT4880A-ACC	Dolly/wheelboard and padded protective cover for one VT4880A.
VT4888-ACC	Dolly/wheelboard and padded protective cover for one VT4888.
VT4882-ACC	Dolly/wheelboard and padded protective cover for one VT4882.
VT4887-ACC	Dolly/wheelboard and padded protective cover for one VT4887A.
VT4881-ACC	Dolly/wheelboard and padded protective cover for one VT4881A.



VT4889-AF (Array Frame)



VT4889-SF (Short Frame)

Suspension Accessories

VT4889-AF	Array Frame for suspending or ground stacking VTX V25, VTX S28, VT4889-1, VT4880, VT4880A enclosures.
VT4889-SF	Short Frame for suspending or ground stacking VTX V25, VTX S28, VT4889-1, VT4880, VT4880A enclosures; can also be used on the bottom of arrays for rear pullback suspension.
VT4888-AF	Array Frame for suspending or ground stacking VT4888 or VT4882 enclosures.
VT4888-SF	Short Frame for suspending or ground stacking VT4888 or VT4882 enclosures; can also be used on the bottom of arrays for rear pullback suspension.
VT4887-AF	Array Frame for suspending or ground stacking VT4887A or VT4881A enclosures.
VT4887-SF	Short Frame for suspending or ground stacking VT4887A or VT4881A enclosures; can also be used on the bottom of arrays for rear pullback suspension.
VT4800-CA	Compact Adaptor, used to suspend VT4887 or VT4887A from VT4888 or VT4882.
VT4800-DA	Downfill Adaptor, used to suspend up to 4 VT4887As or VT4887 enclosures from VTX V25, VTX S28, VT4889, VT4889-1, VT4880 or VT4880A enclosures.
VT4800-UA	Universal Adaptor Frame, used to suspend midsize or compact models from VTX V25, VTX S28, VT4889, VT4889-1, VT4880 or VT4880A enclosures.

VERTEC ACCESSORIES

Separately-ordered accessories for:
VT4886 and VT4883



VT4886-AF Array frame for suspension or ground stacking of VT4883, VT4886, or mixed VT4883/VT4886 arrays.

VT4886-SF Short Array frame for suspension of smaller VT4886 arrays. Can also be used at the bottom of arrays for rear pull-back suspension.



VT4886-DF88 Downfill Adapter for suspending VT4886 under VT4888 or VT4882.

VT4886-DF89 Downfill Adapter for suspending VT4886 under VTX V25, VTX S28, VT4889-1, VT4880, VT4880A.

VT4886-UB Universal Bracket with extension arms for pole mounting, stacking, underbalcony suspension or wall mounting of 1x, 2x, 3x or 4x VT4886 enclosures, respectively.



VT4886-UB1 Basic Universal Bracket for pole mounting, stacking, underbalcony suspension or wall mounting of 1x, 2x or 3x VT4886 enclosures, respectively.



VT4886-HB Horizontal bracket for arraying VT4886 enclosures as a constant curvature horizontal line array. (Suspended or pole mounted.)

SS5-BK Adjustable extension rod with M20 thread for attachment to VT4883 subwoofer. Secure, hand crank height adjustment. Vibration isolation adapter for attachment to optional VT4886-UB, -UB1 or -HB accessories.



JBL-VERTEC-SYS1
An innovative case transport solution for the VERTEC Subcompact Series Line Array loudspeakers and accessories. The case system includes a rugged outer Molded Cover with large twist latches and spring loaded lift handles, two molded caster boards with provisions for 4886 and 4883 cabinets, and a Hardware Storage Tray with integrated Array Frame storage cradle. (Recommended accessory available from www.jblbags.com)



VT4886-UB and VT4886-UB1 are also compatible with:
JBLPOLE-MA
JBLPOLE-GA
JBLTRIPOD-MA
JBL TRIPOD-GA
manual or gas assist extension rod and speaker tripod accessories

VERTEC ACCESSORIES
TOUR SOUND PRODUCTS



VERTEC DP SERIES
TOUR SOUND PRODUCTS



VERTEC® DP SERIES

POWERED LINE ARRAY SOLUTIONS

The JBL VERTEC DP Series combines industry-leading loudspeaker technology with the innovative JBL DrivePack technology platform, delivering superb audio quality and robust power that is perfectly matched to the enclosures with comprehensive internal digital signal processing. Designed in cooperation with development partners Crown, dbx and BSS, JBL DrivePack models are designed to exceed all expectations for loudspeaker performance, power handling and audio system control.

INPUT MODULES & CONNECTIVITY

JBL DrivePacks are equipped with a modular input bay. The standard HiQnet-compatible DPDA input module offers ethernet connectivity for remote control and monitoring. The DPDA module also provides AES digital audio inputs with analog backup, BSS Audio OmniDrive HD™ signal processing with LevelMax™ multi-stage limiting, high-performance FIR/IIR filters, array/box I.D. mechanism and robust EtherCon® connectors optimized for tour/rental applications. We also offer an optional, non-networked lower-cost DPIP input module from dbx with analog audio inputs.



JBL DRIVEPACK DP-DA CONTROL PANEL
For JBL HiQnet Performance Manger™ and System Architect



POWERED BY CROWN iAPP INTERFACE

The Powered by Crown app (available from the Apple App store) allows wireless control and

monitoring of Crown Audio HiQnet networked devices and JBL Professional Drivepack DPDA models. Since the app uses the same protocols as HiQnet System Architect, it is also possible to import custom control panels from System Architect into the Powered by Crown app for added flexibility and functionality.



Mutes and Levels



Input Configuration



Signal Generator

VT4889ADP-DA

POWERED FULLSIZE THREE-WAY LINE ARRAY ELEMENT

Fullsize, lightweight powered enclosure housing two 15" woofers, four 8" midrange transducers, and three high frequency compression drivers.

- 3000W continuous, 6000W peak power rating
- Includes patented Radiation Boundary Integrator
- Rigid lightweight enclosure

VT4888DP-DA

POWERED MIDSIZE THREE-WAY LINE ARRAY ELEMENT

Midsized, lightweight powered line array element housing two 12" woofers, four 5.25" midrange transducers, and two high frequency compression drivers.

- 3000W continuous, 6000W peak power rating
- Includes patented Radiation Boundary Integrator
- Rigid lightweight enclosure

VT4887ADP-DA

POWERED COMPACT BI-AMPED LINE ARRAY ELEMENT

Compact, lightweight powered line array element housing two 8" woofers, four 4" midrange transducers, and two high frequency compression drivers.

- 1100W continuous, 2200W peak power rating
- Includes patented Radiation Boundary Integrator
- Rigid lightweight enclosure

VT4880ADP-DA

POWERED FULLSIZE DUAL 18" ULTRA LONG EXCURSION SUBWOOFER

Fullsize, lightweight, powered centrally-vented arrayable subwoofers housing two 18" woofers with ultra long excursion components.

- 3500 watt continuous power rating
- Dual 2269G Differential Drive woofers
- Rigid lightweight enclosure

VT4882DP-DA

POWERED MIDSIZE DUAL 15" SUBWOOFER

Midsized, lightweight, powered centrally-vented arrayable subwoofer enclosure housing two long-excursion 15" woofers.

- 1700 watt continuous power rating
- Dual 2266H Differential Drive woofers
- Rigid lightweight enclosure

VT4881ADP-DA

POWERED COMPACT 18" SUBWOOFER

Compact, lightweight, powered vented arrayable subwoofer enclosure housing a dual voice coil 18" woofer.

- 1800 watt continuous power rating
- Single 2269H Differential Drive woofers
- Rigid lightweight enclosure

Separately-ordered accessories for: VT4889ADP-DA, VT4888DP-DA, VT4887ADP-DA

VT4889ADP-ACC	Dolly/wheelboard and padded protective cover for one VT4889ADP-DA
VT4888DP-ACC	Dolly/wheelboard and padded protective cover for one VT4888DP-DA
VT4887ADP-ACC	Dolly/wheelboard and padded protective cover for one VT4887ADP-DA

Separately-ordered accessories for: VT4880ADP-DA, VT4882DP-DA, VT4881ADP-DA

VT4880ADP-ACC	Dolly/wheelboard and padded protective cover for one VT4880ADP-DA
VT4882DP-ACC	Dolly/wheelboard and padded protective cover for one VT4882DP-DA
VT4881ADP-ACC	Dolly/wheelboard and padded protective cover for one VT4881ADP-DA



VP SERIES
INSTALLATION PRODUCTS

VP SERIES

SELF-POWERED INTEGRATED AUDIO SYSTEMS

Venue Performance Series is a family of self-powered loudspeaker systems consisting of ten models, suitable for portable or fixed installation sound reinforcement applications where high output, low-distortion, and the highest quality sound are required.

JBL DrivePack®

A key feature of the VP Series are the highly adaptable JBL DrivePack amplifier and signal processing modules. The two channel DP-2 module provides 1100 watts of total continuous power to each fullsize, full-range system while the DP-1 sub-woofer module provides 1800 watts continuous power to the loudspeaker.

The JBL DP-1 and DP-2 DrivePacks operate on auto-selecting line voltages at 50 or 60 Hz for worldwide operation. The compact three channel DPC-2 module used on the smaller VP Series models uses two of the three amplifier channels to enable JBL's Dual Bridge Technology™ (DBT) allowing the most efficient power transfer to the JBL Differential Drive® woofers. DP-1 and DP-2 DrivePack models incorporate Crown's BCA™ (Balanced Current Amplification) Class-I circuitry with temperature-compensated modulation and state of the art feedback circuitry. An extraordinarily efficient passive cooling system eliminates expensive and noisy fans, effecting heat dissipation for optimal cooling.



DPDA Input Module – HiQnet™ Network Compatible with AES Digital Audio and BSS OMNIDRIVE™ HD Signal Processing

Input Modules & Connectivity

JBL DrivePacks DP-1 and DP-2 are equipped with a modular input bay. Standard DPIP input modules from dbx feature analog audio inputs and sophisticated DSP technology incorporating digital pre-equalization filters, frequency dividing networks, and limiter circuitry from one of the most trusted names in signal processing.

DPDA Input Module

The optional DPDA Input Module can be used as a retrofit sub-assembly with any JBL DrivePack equipped loudspeaker system utilizing the DP-1, DP-2, or DP-3 amplifier modules. Upgrading to the DPDA module provides powered loudspeakers users with AES/EBU digital audio capabilities, the sonic benefits of advanced signal processing features and a variety of input and connectivity options.

The VP Series also includes:

- JBL Differential Drive cone transducers
- JBL 2452H-SL 1.5" exit, 4" diaphragm compression driver
- Newly-created stylized, ergonomically designed powder-coated steel handle
- Multiple attachment points for ultimate rigging flexibility with overhead suspension

VP7210/95DP

10" POWERED TWO-WAY INTEGRATED SPEAKER SYSTEM

10" two-way system with the 2452H-SL compression driver. This model features a 90 x 50 rotatable horn. The system is driven by an 875W continuous power three channel DPC-2 JBL DrivePack.

- 875 watts continuous power rating
- 10" Differential Drive woofer for extended low frequency
- 90° x 50° rotatable horn

VP7212MDP

12" POWERED TWO-WAY HIGH IMPACT STAGE MONITOR

Dedicated 12" two-way floor monitor and features 2452H-SL 4" voice coil compression driver. The VP7212MDP is equipped with the JBL DrivePack model DPC-2 with 875W continuous power available.

- 875 watts continuous power rating
- Field rotatable baffle for easy left/right configurations
- 50° x 90° coverage optimized for use as a stage monitor

VP7212/95DPC

12" POWERED TWO-WAY INTEGRATED SPEAKER SYSTEM

A 12" two-way compact system with a 2452H-SL compression driver featuring a 90° x 50° PT waveguide. System is equipped with the JBL DrivePack model DPC-2 with 875W of continuous power.

- 875 watts continuous power rating
- 12" Differential Drive woofer for extended low frequency
- 90° x 50° PT waveguide

VP7215/95DPC

15" POWERED TWO-WAY INTEGRATED SPEAKER SYSTEM

15" two-way compact system with a 2452H-SL compression driver. This model features a 90° x 50° PT waveguide. The system is equipped with the JBL DrivePack model DPC-2 with 875W of continuous power.

- 875 watts continuous power rating
- 15" Differential Drive woofer for extended low frequency
- 90° x 50° PT waveguide

VP7212/64DP (60° x 40°) & VP7212/95DP (90° x 50°)

12" POWERED TWO-WAY INTEGRATED SPEAKER SYSTEM

Two-way speaker systems housing one 12" Differential Drive low frequency transducer and 2452H-SL compression driver. Available with 60° x 40° or 90° x 50° JBL Progressive Transition waveguide.

- 1100 watts continuous power rating
- HiQnet compatible and network controllable
- 60° x 40° or 90° x 50° coverage options

VP7215/64DP (60° x 40°) & VP7215/95DP (90° x 50°)

15" POWERED TWO-WAY INTEGRATED SPEAKER SYSTEM

Two-way speaker systems housing one 15" Differential Drive low frequency transducer and 2452H-SL compression driver. Available with 60° x 40° or 90° x 50° JBL Progressive Transition waveguide.

- 1100 watts continuous power rating
- HiQnet compatible and network controllable
- 60° x 40° or 90° x 50° coverage options

VP7315/64DP

15" POWERED THREE-WAY INTEGRATED SPEAKER SYSTEM

Three-way system with one 15" Differential Drive low frequency transducer, CMCD82H 8" midrange transducer and 2452H-SL compression driver on a JBL PT-K64-MHF Progressive Transition waveguide.

- 1100 watts continuous power rating
- HiQnet compatible and network controllable
- 60° x 40° PT waveguide

VPSB7118DP

18" POWERED INTEGRATED SUBWOOFER SYSTEM

Features one 18" Differential Drive low frequency transducer and an integrated pole mount. The speaker is sized to readily combine into arrays of various configurations using other models in the line.

- 1800 watts continuous power rating
- HiQnet compatible and network controllable
- Fly track suspension points and M10 fittings



MARQUIS DANCE CLUB SERIES
INSTALLATION PRODUCTS



MARQUIS DANCE CLUB SERIES

POWERFUL LOUDSPEAKER SYSTEMS

Designed for high performance dance clubs

As a club designer, your creativity, vision and passion are the heart of an electrifying experience, whether it's a world-class mega-club or an intimate lounge. Knowing this illuminated our vision in creating the new JBL Marquis Dance Club Series - specifically designed for the extreme requirements of large and mega-size clubs.

The Marquis Series comprises eight powerful multi-way systems and subwoofer models that combine JBL's extraordinary sound, proven reliability and state-of-the-art technology with striking architectural design and versatile configurability. From thumping mega dance floors to tranquil VIP lounges, from eclectic chill rooms to complex sound booths, the Marquis Series systematic loudspeaker designs are scalable to smaller venues, ultra lounges, and mega clubs alike. Regardless of the application, the Marquis Series is a multi faceted tool for you to achieve your vision.

JBL Selenium Ultra High Frequency Bullet Drivers

Super high frequencies are handled by the MD1 Super Tweeter module, ensuring extremely high sensitivity and low distortion for transparent response, excellent coverage and long throw.

JBL Progressive Transition™ Waveguides

JBL's patented Progressive Transition™ Waveguides direct the sound of all the Marquis Series compression drivers to provide outstanding pattern control with smooth sound and extremely low distortion even at extraordinarily high dance club volume levels.

JBL Differential Drive® Technology

The entire complement of Marquis Series drivers employ JBL's patented Differential Drive technology which incorporates two voice coils and two magnetic gaps providing higher peak output with less power compression. The MD7 subwoofer also employs JBL's Vented Gap Cooling™ that provides immediate heat transfer for reduced operating temperatures. The result of these technologies is consistent sound quality even at non-stop, mega-club volumes.

MARQUIS

DANCE CLUB SERIES



MD1

DUAL JBL SELENIUM SUPER TWEETERS

Ultra high frequency module with dual JBL Selenium ST400 super tweeters for superior high frequency response. Designed for use with MD2, MD3 and MD7 elements.

- 130 watt continuous power rating
- High fidelity and low distortion
- Dual 40° x 40° coverage pattern

MD2

HIGH POWER MID-HIGH LOUDSPEAKER SYSTEM

Mid-high module utilizing two of JBL's 8" 2169H Differential Drive transducers for mid-band reproduction and the 2453H-SL for high frequencies. Designed for use with MD1, MD3 and MD7 elements.

- 700 watt MF continuous power rating and 100W HF rating
- Dual 8" Differential Drive mid drivers with 4" titanium diaphragm compression driver
- Handles frequencies from 300 Hz to 20 kHz

MD3

HIGH POWER DUAL 15" LOW-FREQUENCY LOUDSPEAKER

Dual 15" low frequency system utilizing dual 2265H Differential Drive transducers in a horn-loaded enclosure. Designed for use with the MD1, MD2, and MD7 elements.

- 1600 watt continuous power rating
- Dual JBL 2265H Differential Drive woofers with 3" dual voice coil
- Handles frequencies from 300 Hz down to 80 Hz

MD7

ULTRA LONG EXCURSION HIGH POWER DUAL 18" SUB

Dual 18" subwoofer system fitted with two JBL 2269H Differential Drive woofers. The MD7 is intended to be used in conjunction with the MD1, MD2, and MD3 elements.

- 4000 watt continuous power rating
- Dual JBL 2269H Differential Drive woofers with 4" dual voice coil
- Capable of frequency response down to 25 Hz

MARQUIS

DANCE CLUB SERIES



MARQUIS DANCE CLUB SERIES
INSTALLATION PRODUCTS



MD52

MEDIUM POWER 90 X 50 12" 2-WAY FULL-RANGE LOUDSPEAKER

Designed for the mobile DJ requiring a light weight high fidelity portable system. The multiangle enclosure features a 45° angle on one side for use as a floor monitor and a pole mount cup for use on a pole or tripod.

- 550 watt continuous power rating
- 90° x 50° rotatable PT waveguide
- Pole mount socket for portable applications

MD55

MEDIUM POWER 90 X 50 15" 2-WAY FULL-RANGE LOUDSPEAKER

Designed for the mobile DJ requiring a light weight high fidelity portable system. The multiangle enclosure features a 45° angle on one side for use as a floor monitor and a pole mount cup for use on a pole or tripod.

- 550 watt continuous power rating
- 90° x 50° rotatable PT waveguide
- Pole mount socket for portable applications

MD46

HIGH POWER 60 X 40 DUAL 15" 4-WAY FULL-RANGE LOUDSPEAKER SYSTEM

High power 60° x 40° dual 15" low frequency system utilizing dual 2265H woofers, CMCD82H 8" mid-range driver, 2432H 3" diaphragm compression driver, and dual ST400 super tweeters.

- Four-way quad amplified system
- 60° x 40° PT waveguide
- Perfect for high energy dance music

MD49

HIGH POWER 90 X 50 DUAL 15" 4-WAY FULL-RANGE LOUDSPEAKER SYSTEM

High power 90° x 50° dual 15" low frequency system utilizing dual 2265H woofers, CMCD82H 8" mid-range driver, 2432H 3" diaphragm compression driver, and dual ST400 super tweeters.

- Four-way quad amplified system
- 90° x 50° PT waveguide
- Perfect for high energy dance music



VLA SERIES

VARIABLE LINE ARRAY LOUDSPEAKERS

Variable Line Array Series (VLA Series) is a revolutionary product providing high-impact sound reinforcement at throw distances beyond the reach of traditional loudspeaker designs. The modular design concept provides the system designer the ability to build large line array systems for larger venue applications or to design smaller line array systems for use as distributed clusters in arenas, domed stadiums and larger performance spaces, including houses of worship.

VLA301

THREE-WAY FULL RANGE LOUDSPEAKER

Three-way full range loudspeaker featuring 2 x 15" LF, 2 x 8" MF, and 3 x 1.5" HF sections with 30° horizontal dispersion.

- 30° horizontal dispersion
- Comprehensive rigging points for line arrays
- JBL's WRC or WRX weather protections finish available as options

VLA301H

HIGH OUTPUT THREE-WAY FULL RANGE LOUDSPEAKER

High output three-way full range loudspeaker featuring 2 x 15" LF, 4 x 8" MF, and 6 x 1.5" HF sections with 30° horizontal dispersion.

- High output design with 30° horizontal dispersion
- Comprehensive rigging points for line arrays
- JBL's WRC or WRX weather protections finish available as options

VLA601

THREE-WAY FULL RANGE LOUDSPEAKER

Three-way full range loudspeaker featuring 2 x 15" LF, 2 x 8" MF, and 3 x 1.5" HF sections with 60° horizontal dispersion.

- 60° horizontal dispersion
- Comprehensive rigging points for line arrays
- JBL's WRC or WRX weather protections finish available as options

VLA601H

HIGH OUTPUT THREE-WAY FULL RANGE LOUDSPEAKER

High output three-way full range loudspeaker featuring 2 x 15" LF, 4 x 8" MF, and 6 x 1.5" HF sections with 60° horizontal dispersion.

- High output design with 60° horizontal dispersion
- Comprehensive rigging points for line arrays
- JBL's WRC or WRX weather protections finish available as options

VLA901

THREE-WAY FULL RANGE LOUDSPEAKER

Three-way full range loudspeaker featuring 2 x 15" LF, 2 x 8" MF, and 3 x 1.5" HF sections with 90° horizontal dispersion.

- 90° horizontal dispersion
- Comprehensive rigging points for line arrays
- JBL's WRC or WRX weather protections finish available as options

VLA901H

HIGH OUTPUT THREE-WAY FULL RANGE LOUDSPEAKER

High output three-way full range loudspeaker featuring 2 x 15" LF, 4 x 8" MF, and 6 x 1.5" HF sections with 90° horizontal dispersion.

- High output design with 90° horizontal dispersion
- Comprehensive rigging points for line arrays
- JBL's WRC or WRX weather protections finish available as options



PD700 SERIES

PRECISION DIRECTIVITY®

One of the challenges in large arenas, stadiums, houses of worship and performance spaces is to provide quality sound to every seat with the volume and clarity demanded by today's concert, sporting and special events. JBL's Precision Directivity line of speakers uses a full range, full bandwidth total system approach that allows contractors and consultants to design a fully integrated sound system solving the audio challenges inherent to these types of large installations.

PD743

HIGH OUTPUT MID-HIGH LOUDSPEAKER SYSTEM

The PD743 is a mid-high loudspeaker system providing high-impact sound reinforcement at throw distances that are beyond the reach of traditional single-driver designs. This system may be used in arrays with other PD series modules or singly as part of a distributed system.

- 40° x 30° coverage pattern
- IFS dual HF driver module eliminates destructive interference
- Pattern control maintained to below 400 Hz

PD764

HIGH OUTPUT MID-HIGH LOUDSPEAKER SYSTEM

The PD764 is a mid-high loudspeaker system providing high-impact sound reinforcement at throw distances that are beyond the reach of traditional single-driver designs. This system may be used in arrays with other PD series modules or singly as part of a distributed system.

- 60° x 40° coverage pattern
- IFS dual HF driver module eliminates destructive interference
- Pattern control maintained to below 400 Hz

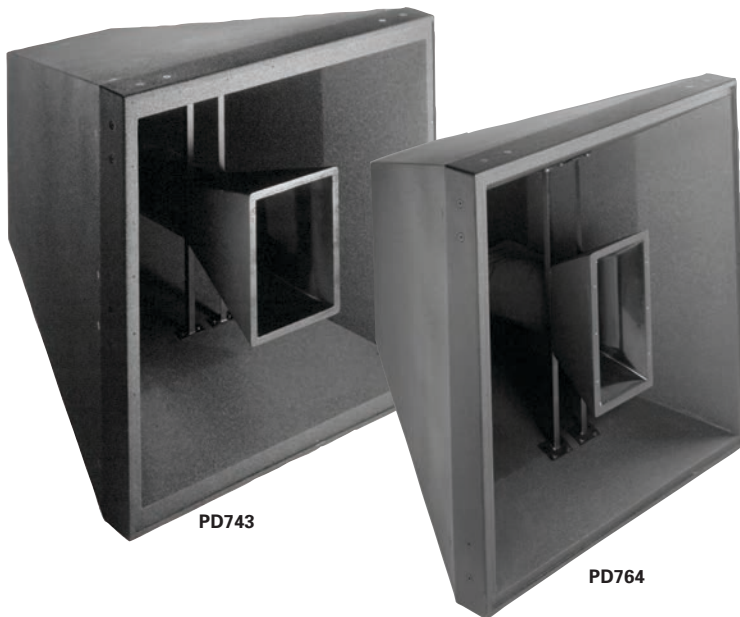

PD700 SERIES
INSTALLATION PRODUCTS





PD6200/43,
PD6200/64 (shown),
PD6200/66,
PD6200/95

PD6000 SERIES

HIGH POWER AND CONSTANT COVERAGE
IN A LOW PROFILE FORM

The PD6000 Series joins JBL's broad lineup of installed sound loudspeakers, complementing the larger PD700 mid-high cabinets with a more compact size and supplementing the smaller AE Series cabinets with higher SPL capability and larger horns for pattern control to a lower frequency. The PD6000 series loudspeakers deliver high power and constant coverage in a low profile form. All speakers include M10 threaded suspension points

PD6200

HIGH OUTPUT MID-HIGH LOUDSPEAKER SYSTEM

Mid-high frequency loudspeakers are designed for applications requiring high output capability with excellent pattern control. The system features a 8" CMCD-82H midrange compression driver and the 2432H large format high frequency compression driver.

MODELS AVAILABLE:

PD6200/43 (40° x 30°)
PD6200/64 (60° x 40°)
PD6200/66 (60° x 60°)
PD6200/95 (90° x 50°)

PD6212

12" FULL-RANGE TWO-WAY LOUDSPEAKER SYSTEM

Full range two-way loudspeakers feature a 12" M222-8A horn-loaded low frequency woofer and a 2453H large format high frequency driver. The speakers can be utilized alone in music or speech systems where frequency extension to 80 Hz is adequate or combined with subwoofers to create extended bandwidth systems.

MODELS AVAILABLE:

PD6212/43 (40° x 30°)
PD6212/64 (60° x 40°)
PD6212/66 (60° x 60°)
PD6212/95 (90° x 50°)

PD6322

DUAL 12" FULL-RANGE THREE-WAY SPEAKER SYSTEMS

Full range three-way loudspeakers feature dual 12" 2206H slot-loaded low frequency woofers, a CMCD-82H cone midrange compression driver and a 2432H large format high frequency driver. The speakers can be utilized alone in music or speech systems where frequency extension to 40 Hz is adequate or combined with subwoofers to create extended bandwidth full range systems.

MODELS AVAILABLE:

PD6322/43 (40° x 30°)
PD6322/64 (60° x 40°)
PD6322/66 (60° x 60°)
PD6322/95 (90° x 50°)

PD5122

DUAL 12" HIGH POWER LOW FREQUENCY MODULE

Designed for use as a flown or ground supported, high power low frequency module used in conjunction with mid/high only or full range systems of the PD6000 series to construct arrays with extended low frequency pattern control.

PD5125

DUAL 15" HIGH POWER LOW FREQUENCY MODULE

Designed for use with mid/high or full range systems of the PD6000 and PD700 series, however it will perform well in any application where high output low bass is required.



PD6212/43 (shown),
PD6212/64, PD6212/66,
PD6212/95



PD6322/43, PD6322/64,
PD6322/66,
PD6322/95 (shown)

AE SERIES

application engineered



AE SERIES

APPLICATION ENGINEERED™: A COMPLETE LINE OF PERMANENT INSTALLATION LOUDSPEAKERS

AE Series loudspeakers are ideal for a wide variety of fixed installation applications including performing arts facilities, theatrical sound design, auditoriums, houses of worship, live music clubs, dance-clubs/discotheques, sports facilities and themed entertainment venues. The special mid-high frequency models can be used without LF reinforcement in voice-only PA and delay-fill applications. The smaller models are ideal in lecture halls and corporate learning centers as well as in delay-fill locations of larger systems.

AE Series models provide a wide variety of building blocks for your system design, stair-stepped to give you just the right solution for your installation.

Within the AE Series are three power levels. The high output level models are found in the 7000 and 6000 Series, the medium output models are found in the 5000 and 4000 Series, and the lower output power level is found in the 2000 Series.

Many AE Series speakers offer selectable crossover modes: tri-amp/bi-amp or bi-amp/passive switchable. In addition, AE Series models incorporate sophisticated crossover designs for outstanding sound quality and consistent coverage. To minimize overlap between adjacent frequency bands, steep slopes are utilized in passive crossovers — most are 4th order (24 dB/octave). This reduces off-axis lobing, providing consistent coverage throughout the crossover region. Conjugate networks are added in some models to fine tune the frequency response for optimum sound quality.



Differential Drive Technology

JBL's exclusive Differential Drive technology is at the core of the AM5212, AM5215, AM7212, AM7215, AM7315, AM7200 and AL7115 as well as the ASB6112, ASB6115, ASB6125, ASB7118 and ASB7128.

This technology reduces weight while enhancing all critical performance parameters.



PT Progressive Transition Waveguides

JBL's new patent pending Progressive Transition waveguides represent the latest in horn technology. In addition to providing smooth, low distortion sound, PT waveguides deliver uniform off-axis frequency response to every point within the intended coverage area.

CMCD™ Cone Midrange Compression Drivers

Incorporated into all cone midrange models — patented CMCD technology is more than a simple displacement plug. In addition to providing increased output and lower distortion, this cone-based true compression driver design extends operational bandwidth (both up and down in frequency) to cover the entire vocal range seamlessly, allows for better waveguide pattern control, and improves phase coherency of the midrange signal for clearer, more intelligible audio quality.



AM7315/xx

AM7315/95 & /64

HIGH-POWER 15" THREE-WAY

The AM7315 loudspeaker system is comprised of a 15" low frequency woofer, one 8" CMCD compression driver, and one 1.5" exit compression driver. The multi-band PT mid-high frequency waveguide provides well controlled coverage and is rotatable for cabinet positioning in either horizontal or vertical orientation.

- Bi-amp and tri-amp switchable
- Includes M10 threaded suspension points
- Available in two models:
AM7315/95 - 90° x 50°
AM7315/64 - 60° x 40°



AM7200/xx

AM7200/95 & /64

HIGH-POWER MID HIGH

The AM7200 loudspeaker system is comprised of one 8" CMCD compression driver and one 1.5" exit compression driver. The multi-band PT mid-high frequency waveguide provides well controlled coverage and is rotatable for cabinet positioning in either horizontal or vertical orientation.

- Bi-amp and tri-amp switchable
- Includes M10 threaded suspension points
- Available in two models:
AM7200/95 - 90° x 50°
AM7200/64 - 60° x 40°



AM7212/xx

AM7212/64-66-95-00-26

HIGH-POWER 12" TWO-WAY

The AM7212 loudspeaker system is comprised of one 12" Differential Drive 2262H woofer and a 2432H high frequency compression driver. The large format PT waveguide provides excellent coverage and is rotatable for use in either the vertical or horizontal orientation. Available in black or white and WRC/WRX finishes.

- 700 watt continuous power rating
- Available in five models:
AM7212/64: 60° x 40°
AM7212/66: 60° x 60°
AM7212/95: 90° x 50°
AM7212/00: 100° x 100°
AM7212/26: 120° x 60°



AM7215/xx

AM7215/64-66-95-26

HIGH-POWER 15" TWO-WAY

The AM7215 loudspeaker system is comprised of one 15" Differential Drive 2265H woofer and a 2432H high frequency compression driver. The large format PT waveguide provides excellent coverage and is rotatable for use in either the vertical or horizontal orientation.

- 750 watt continuous power rating
- Available in four models:
AM7215/64: 60° x 40°
AM7215/66: 60° x 60°
AM7215/95: 90° x 50°
AM7215/26: 120° x 60°



AM5212/xx

AM5212/64-66-95-00-26

MEDIUM-POWER 12" TWO-WAY

The AM5212 loudspeaker system is comprised of one 12" Differential Drive 262H-1 woofer and a 2408H-1 high frequency compression driver. The large format PT waveguide provides excellent coverage and is rotatable for use in either the vertical or horizontal orientation. Available in black or white and WRC/WRX finishes.

- 300 watt continuous power rating
- Available in five models:
AM5212/64: 60° x 40°
AM5212/66: 60° x 60°
AM5212/95: 90° x 50°
AM5212/00: 100° x 100°
AM5212/26: 120° x 60°



AM5215/xx

AM5215/64-66-95-26

MEDIUM-POWER 15" TWO-WAY

The AM5215 loudspeaker system is comprised of one 15" Differential Drive 265H-1 woofer and a 2408H-1 high frequency compression driver. The large format PT waveguide provides excellent coverage and is rotatable for use in either the vertical or horizontal orientation.

- 350 watt continuous power rating
- Available in four models:
AM5215/64: 60° x 40°
AM5215/66: 60° x 60°
AM5215/95: 90° x 50°
AM5215/26: 120° x 60°



AC2212/xx

AC2212/95, /64 & /00

LOWER-POWER 12" TWO-WAY

The AC2212 loudspeaker system is comprised of one 12" JBL M112-8 woofer and a 2412H/MTA high frequency compression driver. The PT waveguide provides good pattern control with low distortion.

- 250 watt continuous power rating
- Optional U-Bracket and planar array frame kit
- Available in three models:
AC2212/95: 90° x 50°
AC2212/64: 60° x 40°
AC2212/00: 100° x 100°



AC2215/xx

AC2215/95, /64 & /00

LOWER-POWER 15" TWO-WAY

The AC2215 loudspeaker system is comprised of one 15" JBL M115-8A woofer and a 2412H/MTA high frequency compression driver. The PT waveguide provides good pattern control with low distortion.

- 250 watt continuous power rating
- Optional U-Bracket for easy installation
- Available in three models:
AC2215/95: 90° x 50°
AC2215/64: 60° x 40°
AC2215/00: 100° x 100°



AL7115

AL7115

HIGH POWER 15" LOW FREQUENCY TRAPEZOIDAL LOUDSPEAKER SYSTEM

The AL7115 loudspeaker system is comprised of one 15" JBL Differential Drive 2265H woofer in a front-loaded, vented configuration. This model arrays with various AE series mid-high frequency and compact two-way models.

- 600 watt continuous power rating
- Large vented area for high output with low distortion
- Fitted with M10 threaded suspension points





ASB6118

ASB6118

HIGH POWER 18" SUBWOOFER SYSTEM

The ASB6118 subwoofer system is comprised of one 18" JBL 2242H SVG woofer in a vented, front-loaded configuration.

- 800 watt continuous power rating
- Large vented area for high output with low distortion
- Arrays with AM7200 mid-high speakers and AM2212 full-range speakers.



ASB6128

ASB6128

HIGH POWER DUAL 18" SUBWOOFER

The ASB6128 subwoofer system is comprised of two 18" JBL 2242H SVG woofers in a vented, front-loaded configuration. The deep cabinet allows for extended low frequency bandwidth with minimal frontal profile.

- 1600 watt continuous power rating
- Large vented area for high output with low distortion
- Arrays with various AE series models



ASB4128

ASB4128

MEDIUM POWER DUAL 18" SUBWOOFER

The ASB4128 subwoofer system is comprised of two 18" JBL 2042H woofers in a vented, front-loaded configuration. The deep cabinet allows for extended low frequency bandwidth with minimal frontal profile.

- 600 watt continuous power rating
- Large vented area for high output with low distortion
- Arrays with various AE series models



ASB6128V

ASB6128V

HIGH POWER DUAL 18" SUBWOOFER

The ASB6128V subwoofer system is comprised of two 18" JBL Differential Drive 2258H woofers in a folded baffle V configuration. The V configuration provides additional sensitivity in the deep-bass region as well as tighter clustering of drivers for better mutual coupling in arrays.

- 1600 watt continuous power rating
- Large vented area for high output with low distortion
- Arrays with various AE series models

ASH6118

HIGH POWER 18" HORN-LOADED SUB

The ASH6118 subwoofer system is comprised of one horn-loaded 18" JBL 2242H SVG woofer. The slow expansion internal folded horn provides maximum sensitivity, output level and subwoofer impact.

- 800 watt continuous power rating
- Designed to be used singly or in multiples
- Excellent "punch" with true sub-bass extension



ASH6118



ASB6115

ASB6115

HIGH POWER LIGHTWEIGHT 15" SUB

The ASB6115 subwoofer system is comprised of one 15" JBL Differential Drive 2265H-1 woofer in a vented, front-loaded enclosure. This system is for ground-stacked or suspended applications in combination with other AE series products.

- 800 watt continuous power rating
- Can be used ground-stacked or in stand-alone arrays
- Integrated M10 threaded suspension points



ASB6125

ASB6125

HIGH POWER LIGHTWEIGHT DUAL 15" SUB

The ASB6125 subwoofer system is comprised of two 15" JBL Differential Drive 2265H-1 woofer in a vented, front-loaded enclosure. This system is for ground-stacked or suspended applications in combination with other AE series products.

- 1600 watt continuous power rating
- Parallel or discrete switchable input mode
- Integrated M10 threaded suspension points



ASB7128

ASB7128

HIGH POWER ULTRA LONG EXCURSION 18" SUBWOOFER

The ASB7128 high power subwoofer system is comprised of two 18" JBL Differential Drive 2269H ultra long excursion woofers. JBL's exclusive vented gap cooling and ultra robust composite cone ensure extra long life.

- 4000 watt continuous power rating
- Woofers capable of peak-to-peak excursion of 3.5" (89mm)
- Can be used ground-stacked or in stand-alone arrays



ASB7118

ASB7118

HIGH POWER ULTRA LONG EXCURSION DUAL 18" SUBWOOFER

The ASB7118 high power subwoofer system is comprised of one 18" JBL Differential Drive 2269H ultra long excursion woofer. JBL's exclusive vented gap cooling and ultra robust composite cone ensure extra long life.

- 2000 watt continuous power rating
- Woofer capable of peak-to-peak excursion of 3.5" (89mm)
- Can be used ground-stacked or in stand-alone arrays



ASB6112

ASB6112

HIGH POWER COMPACT 12" SUBWOOFER SYSTEM

The ASB6112 compact subwoofer system is comprised of one 12" JBL Differential Drive 2263H woofer.

- 1000 watt continuous power rating
- Large vent area for high output with low distortion
- Can be used ground-stacked or in stand-alone arrays



AE SERIES COMPACT MODELS



AE SERIES COMPACT MODELS

AN EXTENSION OF THE INDUSTRY LEADING AE SERIES

AC15

Ultra compact enclosure with one 5.25" LF transducer and 90° x 90° waveguide with 25 mm (1in) dome tweeter. It is equipped with attachment points for a U-bracket and OmniMount® type bracket.

AC25

The features of the AC15 with two 5.25" LF transducers.

AC16

Ultra compact enclosure with one 6.5" LF transducer and a 90° x 90° Progressive Transition™ Waveguide with a 25 mm (1 in) exit compression driver. It is equipped with attachment points for a U-bracket, OmniMount® type bracket and stand mount adapter.

AC26

The features of the AC16 with two 6.5" LF transducers.

AC18/95 & AC18/26

Compact enclosures with one 8" LF transducer and a 90° x 50° Progressive Transition Field Rotatable Waveguide with a 1" exit compression driver (AC18/95) or 120° x 60° Progressive Transition™ Field Rotatable Waveguide with a 1" exit compression driver (AC18/26). They are equipped with attachment points for a U-bracket, OmniMount type bracket and stand mount adapter

AC28/95 & AC28/26

The features of the AC18/95 & AC18/26 with two 8" LF transducers.

An extension of the industry leading AE Series, the AE Compact family consists of high output, 2-way loudspeaker systems combining flexibility with high fidelity. Ranging from a single 5.25" point-and-shoot box to dual 8" loudspeaker system that are specifically designed for better serving the needs of both designers and artists alike.

The ultra-compact AC15 and AC25 models include a 1" dome tweeter while the AC16, AC26, AC18, and AC28 models feature 1" exit compression drivers providing sonic clarity and crisp detail. The AC18 and AC28 featuring JBL's Progressive Transition™ Rotatable Waveguides, offer the system designer a choice of coverage patterns in either 90° x 50° or 120° x 60°.



The measured response of the CWT128 is even throughout the frequency spectrum.

CWT SERIES

EXTREMELY WIDE-ANGLE COVERAGE LOUDSPEAKER SYSTEM

To provide high quality, full bandwidth sound evenly dispersed across a coverage area greater than 100 degrees, often two speaker systems are mounted and splayed to achieve wider horizontal coverage. But this approach produces interference where the coverage patterns overlap resulting in uneven sound fields and compromised intelligibility. JBL engineers created an innovative solution to this problem: the CWT128 loudspeaker system featuring CWT Crossfired Waveguide Technology. Drawing on its vast experience in the art and science of loudspeaker technology, JBL continually sets new standards for the audio industry while creating elegant solutions for the challenges that face all sound professionals.

Crossfire Waveguide Technology

At the heart of the CWT128 is the CWT Waveguide featuring a wide coverage pattern designed to provide seamless horizontal coverage across a full 160°. Based on JBL patented technology, the CWT Waveguide is essentially split in half and loaded with two compression drivers facing in different directions. The waveguide delivers wide angle coverage in a single enclosure, exhibiting no interference, and providing remarkable off-axis response. By eliminating multiple sets of speakers that interfere with each other, the overall fidelity of the system is greatly improved, intelligibility is increased, and a more pleasant listening experience is provided for the audience.

CWT128

HIGH OUTPUT DUAL 8" LOUDSPEAKER SYSTEM

The CWT128 is a compact full-range system with dual 8" SFG drivers and a 1" exit compression driver. It is designed to provide maximum bandwidth and SPL in a single package system.

- 850 watt continuous power rating
- Unique CWT waveguide for seamless horizontal coverage across a full 160 degrees
- Includes 70/100V transformer taps
- Dual 8" JBL SFG™ (Symmetrical Field Geometry) LF drivers
- Designed to work in a variety of performance spaces, especially those where a speaker system configuration is required in smaller, architecturally sensitive environments.



AE ALL WEATHER SERIES

ALL WEATHER SERIES: EXCELLENT PROTECTION IN THE HARSHTEST ENVIRONMENTS

The JBL ALL WEATHER SERIES is a family of high power, lightweight, 2-way, full-range loudspeaker systems comprised of the JBL Differential Drive® dual voice coil and dual magnetic gap low frequency 12" and 15" woofers and 2432H high-frequency 38mm (1.5 in) exit, 75mm (3 in) voice-coil compression driver. The large format Progressive Transition wave-guides provide excellent high-frequency coverage patterns. The waveguides are rotatable so the loudspeaker system can be used in either the vertical or horizontal orientation. AW200-LS and AW500-LS are EN54-24 compliant.

The enclosures are constructed of multilayer glass composite and are heavily braced to maximize low-frequency performance. The 14-gauge stainless steel grille, backed with open cell foam and stainless steel mesh, provides excellent protection in the harshest environments. All systems are equipped with a 400W 70/100V transformer.

AE SERIES ALL WEATHER

- Weather-resistant, all fiberglass enclosure
- Differential Drive® low frequency driver
- U-Type mounting bracket included
- Variety of coverage patterns for versatile installation use
- Available in an -LS model for EN54-24 compliance

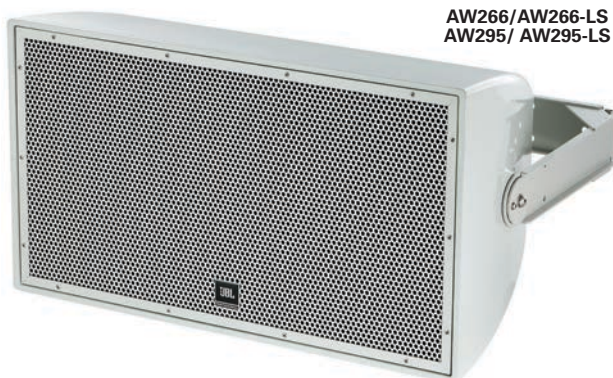

AW266/ AW266-LS
AW295/ AW295-LS



AW526/ AW526-LS
AW566/ AW566-LS
AW595/ AW595-LS

AW266 & AW266-LS

HIGH POWER 12" TWO-WAY FULL-RANGE ALL-WEATHER LOUDSPEAKER

The AW266 loudspeaker is comprised of one 12" JBL Differential Drive 2262H woofer and 2432H high-frequency compression driver. The large format Progressive Transition waveguide provides excellent coverage and allows for vertical or horizontal orientation.

- 400 watt continuous power rating (-LS)
- 60° x 60° coverage pattern
- 400W 70/100V transformer included
- Durable U-type mounting bracket included

AW295 & AW295-LS

HIGH POWER 12" TWO-WAY FULL-RANGE ALL-WEATHER LOUDSPEAKER

The AW295 loudspeaker is comprised of one 12" JBL Differential Drive 2262H woofer and 2432H high-frequency compression driver. The large format Progressive Transition waveguide provides excellent coverage and allows for vertical or horizontal orientation.

- 400 watt continuous power rating (-LS)
- 90° x 50° coverage pattern
- 400W 70/100V transformer included
- Durable U-type mounting bracket included

AW526 & AW526-LS

HIGH POWER 15" TWO-WAY FULL-RANGE ALL-WEATHER LOUDSPEAKER

The AW526 loudspeaker is comprised of one 15" JBL Differential Drive 2265H woofer and 2432H high-frequency compression driver. The large format Progressive Transition waveguide provides excellent coverage and allows for vertical or horizontal orientation.

- 400 watt continuous power rating (-LS)
- 120° x 60° coverage pattern
- 400W 70/100V transformer included
- Durable U-type mounting bracket included

AW566 & AW566-LS

HIGH POWER 15" TWO-WAY FULL-RANGE ALL-WEATHER LOUDSPEAKER

The AW566 loudspeaker is comprised of one 15" JBL Differential Drive 2265H woofer and 2432H high-frequency compression driver. The large format Progressive Transition waveguide provides excellent coverage and allows for vertical or horizontal orientation.

- 400 watt continuous power rating (-LS)
- 60° x 60° coverage pattern
- 400W 70/100V transformer included
- Durable U-type mounting bracket included

AW595 & AW595-LS

HIGH POWER 15" TWO-WAY FULL-RANGE ALL-WEATHER LOUDSPEAKER

The AW595 loudspeaker is comprised of one 15" JBL Differential Drive 2265H woofer and 2432H high-frequency compression driver. The large format Progressive Transition waveguide provides excellent coverage and allows for vertical or horizontal orientation.

- 400 watt continuous power rating (-LS)
- 90° x 50° coverage pattern
- 400W 70/100V transformer included
- Durable U-type mounting bracket included



Available in light gray or black (-BK)

AWC SERIES

COMPACT FULL-RANGE 2-WAY COAXIAL AND LOW FREQUENCY LOUDSPEAKER SYSTEMS

The AWC Series is ideal for speech and music in a wide variety of applications, including sports facilities, racetracks, stadiums, fairgrounds, rodeos, skating rinks, themed entertainment venues, cruise ships, water parks, outdoor background music/paging systems, swimming pools, and a wide variety of other outdoor or indoor venue types.

The AWC82 has a high-power coaxial 200 mm (8 in) low frequency driver and 25 mm (1 in) high frequency compression driver, while the AWC129 is comprised of a high-power co-axial 300 mm (12 in) low frequency driver and 25 mm (1 in) high frequency compression driver. The AWC159 is comprised of a high-power co-axial 380mm (15 in) low frequency driver and 38mm (1.5 in) high frequency compression driver, and the AWC15LF utilizes a 380mm (15 in) low frequency driver for consistent LF output. All full-range models feature a unique tapered pole-piece design that transitions to the cone of the low frequency driver to form a large diameter pattern control waveguide for the high frequencies, both eliminating high-frequency beaming, which is common among this category of speaker, and extending pattern control to the lowest possible frequencies. The result is extremely consistent coverage – wide 120° for AWC82 and more focused 90° for AWC129 and AWC159 – on a broadband basis. Available in light gray or black.

AWC82

COMPACT 8" ALL-WEATHER TWO-WAY COAXIAL LOUDSPEAKER

The AWC82 is a compact two-way highly weather-resistant full-range loudspeaker system which is ideal for speech and music-fill in a wide variety of applications.

- 250 watt power handling provides high SPL capability
- Consistent 120° x 120° broadband pattern control
- Highly weather-resistant IP56 rating

AWC129

COMPACT 12" ALL-WEATHER TWO-WAY COAXIAL LOUDSPEAKER

The AWC129 is a compact two-way highly weather-resistant full-range loudspeaker system which is ideal for speech and music-fill in a wide variety of applications.

- 400 watt power handling provides high SPL capability
- Consistent 90° x 90° broadband pattern control
- Highly weather-resistant IP56 rating

AWC159

COMPACT 15" ALL-WEATHER TWO-WAY COAXIAL LOUDSPEAKER

The AWC159 is a compact two-way highly weather-resistant full-range loudspeaker system which is ideal for speech and music-fill in a wide variety of applications.

- 500 watt power handling provides high SPL capability
- Consistent 90° x 90° broadband pattern control
- Highly weather-resistant IP56 rating

AWC15LF

COMPACT 15" ALL-WEATHER LOW-FREQUENCY SPEAKER

The AWC15LF is a compact highly weather resistant loudspeaker for augmenting the low frequency capability of a sound system, and is ideal for use with other AWC full-range loudspeakers.

- 500 watt power handling capacity
- low frequency extension down to 45 Hz
- Highly weather-resistant IP56 rating



CBT SERIES

LINE ARRAY COLUMN LOUDSPEAKERS

The JBL CBT Series line array columns with Constant Beamwidth Technology break new ground in performance, versatility, and affordability. Designed for venues that would typically use larger point-and-shoot speakers or powered columns, the CBT models incorporate patented technical advancements that allow them to vastly outperform competitive systems, with a level of user-friendliness that virtually eliminates the challenges of delivering great sound. With a slim compact design in fiberglass reinforced ABS enclosures, the CBT Series fits well into virtually any decor. Available in black or white.

CBT SERIES
COMMERCIAL SOUND PRODUCTS



CBT 50LA-1

CBT LINE ARRAY COLUMN WITH EIGHT 2" DRIVERS

The CBT 50LA-1 is the most compact of the models. At 150 watts, it holds its own against larger competitive columns. Response to 80 Hz works well for speech or music. Voicing can be set for music (flat) or speech via a switch.

- 150 watt power handling provides high SPL capability
- Built-in 70V/100V transformer plus 8 ohm direct capability
- Swivel (pan)/tilt wall bracket included

CBT 50LA-LS

CBT LINE ARRAY COLUMN WITH EN54 CERTIFICATION

Same as above CBT 50LA-1 but certified for EN54 applications.

- 150 watt power handling provides high SPL capability
- Built-in 70V/100V transformer plus 8 ohm direct capability
- Swivel (pan)/tilt wall bracket included

CBT 100LA-1

CBT LINE ARRAY COLUMN WITH SIXTEEN 2" DRIVERS

The CBT 100LA-1 contains sixteen 2" drivers in a slim, compact cabinet, providing excellent pattern control. Vertical coverage is adjustable via a switch and voicing is switchable between music (flat) or speech setting, making this model a great choice for a wide variety of environments.

- 325 watt power handling for high SPL
- Vertical coverage switchable between 40 degrees and 15 degrees
- Built-in 70V/100V transformer plus 8 ohm direct capability

CBT 100LA-LS

CBT LINE ARRAY COLUMN WITH EN54 CERTIFICATION

Same as above CBT 100LA-1 but certified for EN54 applications.

- 325 watt power handling for high SPL
- Vertical coverage switchable between 40 degrees and 15 degrees
- Built-in 70V/100V transformer plus 8 ohm direct capability

CBT 70J-1

CBT TWO-WAY LINE ARRAY COLUMN WITH ASYMMETRICAL VERTICAL COVERAGE

The CBT is a two-way speaker with high fidelity and response down to 60 Hz, 500W power handling, high sensitivity and high SPL capability. This model provides Asymmetrical Progressive Gradient coverage sending more sound toward the far area of the listening space.

- 500 watt power handling provides high SPL capability
- Vertical coverage switchable between 45 degrees and 15 degrees
- Sixteen 1" soft dome tweeters and four high power LF drivers

CBT 70JE-1

The CBT 70JE-1 extension speaker is purpose-built for use with CBT 70J-1, lengthening the line array to extend the pattern control, extending the bass response, and increasing power handling and SPL levels in the LF range.

- 500 watt power handling
- Four high power 125 mm (5 in) LF drivers
- Matches form factor of CBT 70J-1. Coupler plate included.

CBT 70J-1 + CBT70JE-1

PURPOSE DESIGNED EXTENSION FOR CBT70J-1 LINE ARRAY COLUMN

The CBT 70J-1 + 70JE-1 array system is twice the height of a 70J-1, extending the pattern control down to below 400Hz, including the voice range and much of the music range. This unobtrusive column array system provides 1000 watts of continuous power handling (peaks of 4000 watts), high sensitivity and very high maximum output capability, with a frequency response that extends down to 45 Hz.

- 1000 watt power handling provides high SPL capability
- 70JE-1 has built-in crossover network for combining with 70J-1
- Provides extended pattern control down to 400 Hz and frequency response to 45 Hz.

CBT 200LA-1

CBT LINE ARRAY COLUMN WITH THIRTY-TWO 2" DRIVERS

With a height of 200 cm (6.6 ft), CBT 200LA-1 is the tallest model, providing useful pattern control down to below 200 Hz. The top and bottom speaker modules allow individual adjustment of music (flat)/ speech voicing and vertical pattern settings. Setting in Asymmetrical Progressive Gradient coverage mode (top narrow; bottom broad) sends more sound toward the far listening area versus close for more even SPL near-to-far in the listening space.

- 650 watt power handling provides high SPL capability
- Vertical coverage switchable between 30 degrees and 15 degrees
- Provides extended pattern control down to 200 Hz

ACCESSORIES

MTC-CBT-70T - Transformer module for CBT 70J-1 or 70J-1+70JE-1 array, bolts onto back, 70V/100V taps at 120W, 60W, 30W (plus 15W for 70V), gland nuts for water tight seal.

MTC-CBT-SMB1 – Stand Mount Bracket fits all models for portable applications. Note: For stability, CBT 70J+E array system and CBT 200LA-1 requires larger, heavier-duty stand than JBL SS2-BK.

MTC-CBT-FM1 – Low-profile, close-to-wall mounting bracket for use with CBT 50LA-1, CBT50LA-LS, and CBT 100LA-1 and CBT 100LA-LS.

MTC-CBT-FM2 – Low-profile, close-to-wall mounting bracket for use with CBT 70J-1 and CBT 70J-1/70JE-1 array.

CBT Calculator Software – For designing CBT speakers into projects. Download from jblpro.com website.

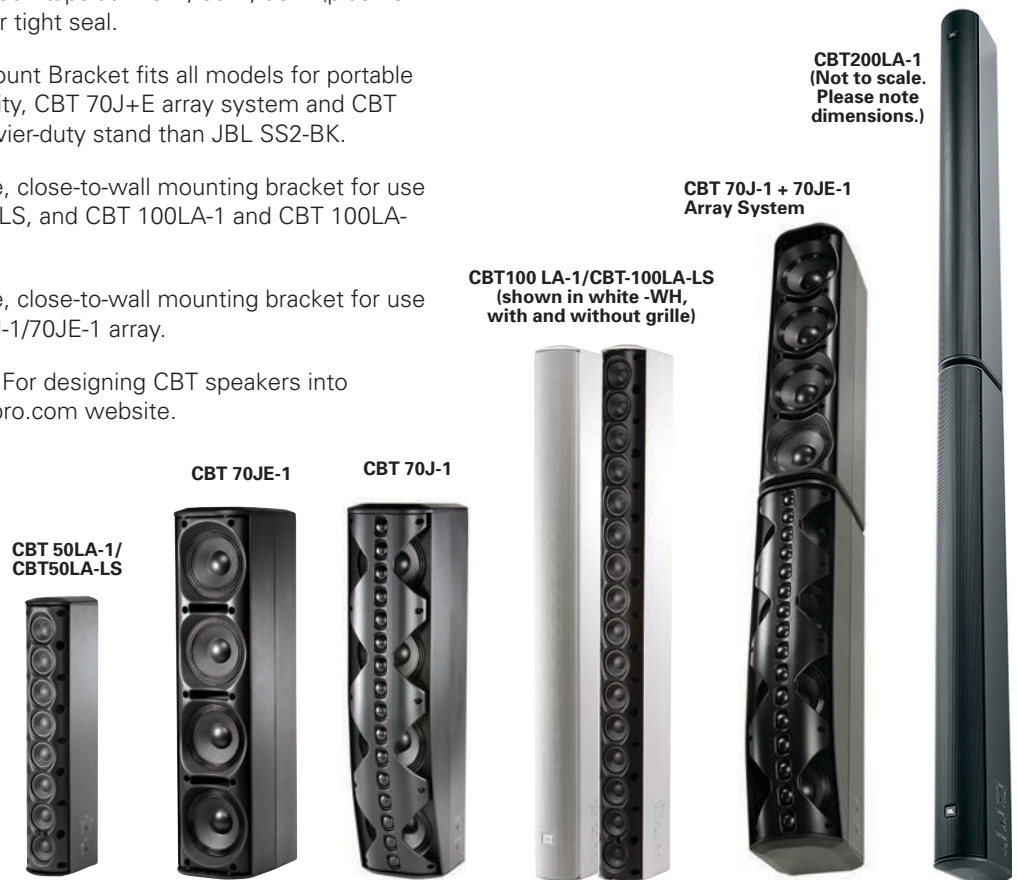

All models include grilles, which are removed in photos to illustrate driver composition.

COMMERCIAL SOUND PRODUCTS
CBT SERIES





CONTROL® 60 SERIES

HIGH PERFORMANCE PENDANT LOUDSPEAKERS

The Control 60 Series bring renowned JBL sound and outstanding coverage to rooms and venues with open architecture or high-ceilings, while providing superior voice and musical clarity for rooms with difficult acoustics. Easy to install hanging hardware is included, featuring redundant suspension cables and UL listed adjustable height hangers.

CONTROL 60 SERIES
COMMERCIAL SOUND PRODUCTS



CONTROL 62P

2.5" ULTRA COMPACT SATELLITE PENDANT SPEAKER

The Control 62P is great for speech and mid-high music applications (external high-pass required) in visually sensitive applications. For full-range applications, up to 4 pieces can be driven from a Control 50S/T or 40CS/T subwoofer. Available in Black or White.

- 25 watt continuous power rating
- Can intermix with Control 52 and Control 42C satellite speakers
- 140° nominal coverage angle

CONTROL 65P/T

5.25" COMPACT FULL-RANGE PENDANT SPEAKER

The Control 65P/T incorporates JBL's exclusive RBI Radiation Boundary Integration technology to provide very consistent, wide coverage throughout the listening space. Available in Black or White.

- 75 watt continuous power rating
- 120° conical coverage pattern
- Max SPL @1m: 105dB pink noise, 111 dB peak

CONTROL 67P/T

6.5" EXTENDED FULL-RANGE PENDANT SPEAKER

The Control 67P/T incorporates a larger enclosure and high power 6.5" transducer for extended bass output capability. Available in Black or White.

- 75 watt continuous power rating
- 120° conical coverage pattern
- Max SPL @1m: 109dB pink noise, 115 dB peak

CONTROL 67HC/T

6.5" HIGH CEILING PENDANT SPEAKER

The Control 67HC/T has well controlled narrow coverage, ideal for improved voice intelligibility and musical clarity in high-ceiling venues or in rooms with difficult acoustics. Available in Black or White.

- 75 watt continuous power rating
- Well-controlled 75° conical coverage pattern
- Max SPL @1m: 112dB pink noise, 118 dB peak

Control 60PS/T

8" PENDANT SUBWOOFER WITH CROSSOVER

The Control 60 PS/T provides bass and extension, high impact and good transient response for high-fidelity sound systems. Available in Black or White.

- 150 Watt continuous power rating
- Low Frequency extension down to 42 Hz
- Max SPL @ 1m: 107 dB pink noise, 113 dB peak

ACCESSORIES

MTC-PC60: Terminal Cover for C65P/T, C67P/T, C67HC/T & C60PS/T

MTC-PC62: Terminal Cover for C62P

CONTROL® 50 SERIES

SURFACE-MOUNT SUBWOOFER-SATELLITE SYSTEM

The Control 50 Series subwoofer-satellite loudspeaker system provides high fidelity sound in any location where full-range high fidelity foreground/background music is required from a surface-mount system.

The Control 50S/T subwoofer can be utilized with either two of four Control 52 satellite speakers. The Control 50 system is mono. Both the Control 50S/T and Control 52 can be intermixed in systems along with the Control 40 Series in-ceiling models – Control 40CS/T subwoofer and Control 42 satellite speaker – to match the form factor requirements of a wide variety of applications.



The C50PACK includes 4) Control 52 satellite speakers and 1) Control 50 subwoofer as shown. The Control 50 Series is also available individually.

CONTROL 52

2.5" SURFACE-MOUNT SATELLITE LOUDSPEAKER

The Control 52 satellite loudspeaker produces superb high fidelity sound via a low distortion 2.5" driver. The included wall bracket allows each speaker to be angled up to 45 degrees off-axis.

- 50 watt continuous power rating
- Wall-mount brackets included
- 150° x 150° nominal coverage angle

CONTROL 50S/T

8" SURFACE-MOUNT SUBWOOFER SYSTEM

The Control 50S/T subwoofer contains a high-power, long excursion, 8" driver which provides extended low frequency response. The Control 50S/T installs quickly with its included two-piece easy-mount wall-bracket.

- 300 watt continuous power rating
- Selectable 70V/100V for distributed lines or low impedance
- Usable with Control 42C and Control 62P Models

CONTROL 50PACK

PACKAGED SURFACE-MOUNT SUBWOOFER-SATELLITE LOUDSPEAKER SYSTEM

The Control 50Pack includes four Control 52 satellite speakers and one Control 50S/T subwoofer. Available in Black and White.

- Versatile four satellite speaker system
- Wall mount brackets included
- Low Frequency Down to 32 Hz (-10dB)

CONTROL® CONTRACTOR

SURFACE MOUNT SPEAKERS



The CONTROL 25AV-LS is Kitemark approved and UL1480 UUMW listed for use in fire alarm and/or emergency communication systems.

The Control Contractor Surface speakers are compact systems with rugged, molded high impact polystyrene shells. Designed for wide-ranging indoor and outdoor (except SB-2) applications, the Control Contractor Series offers versatility, ease-of-installation and paintability. JBL's Invisiball® mounting technology revolutionizes ease-of-installation with built-in hardware easily secured with a standard hex wrench from the front (except Control CRV). Mounting bracket is included. Available in black or white (except Control SB2).

CONTROL 23 & 23T

HIGH OUTPUT TWO-WAY MID-HIGH LOUDSPEAKER

The Control 23 has a 3.5" woofer and horn-loaded titanium-coated tweeter ideal for mid/high operation in limited space environments. The Control 23T model has a pre-installed transformer.

- 50 watt continuous program power rating
- Conforms to Mil Spec 810 and IEC529 IP-X4
- Readily paintable to match decor

CONTROL 25 & 25T

COMPACT BACKGROUND/FOREGROUND LOUDSPEAKER

The Control 25 incorporates a 5.25" low frequency loudspeaker with a horn-loaded 1" titanium coated tweeter ideal for moderately large venues. The Control 25T model has a pre-installed transformer.

- 150 watt continuous program power rating
- Conforms to Mil Spec 810 and IEC529 IP-X4
- Readily paintable to match decor

CONTROL 25AV & 25AV-LS

COMPACT BACKGROUND/FOREGROUND LOUDSPEAKER

The Control 25 is an especially wide band-width, smooth response speaker. It features a top quality 70V/100V transformer for distribution systems which can also be bypassed for use as an 8 ohm speaker.

The Control 25AV-LS is UL1480 UUMW listed for use in fire alarm and/or emergency communication systems. Also EN52-24 certified.

- 200 watt continuous program power rating
- 60 watt transformer for 70V or 100V, and 8 ohm
- Especially wide bandwidth and smooth response.

CONTROL 28 & 28T-60

HIGH OUTPUT BACKGROUND/FOREGROUND SPEAKER

The Control 28 offers high power, performance, bandwidth and sensitivity in a compact full range speaker with an 8" woofer and 1" tweeter. Control 28T-60 contains a multi-tap transformer.

- 175 watt continuous program power rating
- Conforms to Mil Spec 810 and IEC529 IP-X4
- Readily paintable to match decor

CONTROL CRV

CONTEMPORARY CURVED DESIGN LOUDSPEAKER

The Control CRV brings high design and versatility to both indoor and outdoor commercial applications. The CRV incorporates dual 4" woofers and a 3/4" titanium tweeter.

- 75 watt continuous program power rating
- Combinable in half-round or full-round clusters
- Available in black or white finish



CONTROL CRV



L to R:
CONTROL 23/23T
CONTROL 25/25T
CONTROL 25AV & AV-LS
CONTROL 28/28T-60

CONTROL CONTRACTOR SERIES
COMMERCIAL SOUND PRODUCTS



CONTROL 29AV-1

PREMIUM INDOOR/OUTDOOR MONITOR SPEAKER

The Control 29AV-1 utilizes high power components and a complex network to achieve smooth high fidelity performance and a well-controlled defined coverage from a compact loudspeaker.

- 300 watt continuous program power rating
- Compression driver HF
- 110° x 85° HF coverage with rotatable horn

CONTROL 30

HIGH OUTPUT THREE-WAY MONITOR SPEAKER

The Control 30 is a three-way high output speaker designed for multiple uses. Weather resistance has been maximized, making the Control 30 suitable for outdoor applications. Includes 70V/100V multi-tap transformer.

- 500 watt continuous program power rating
- Conforms to Mil Spec 810 and IEC529 IP-X4
- 120° x 120° HF coverage

CONTROL SB2

STEREO INPUT DUAL COIL 10" SUBWOOFER

The Control SB-2 functions as the subwoofer section of left/right music systems, preserving the stereo separation. The dual coil 10" transducer has been optimized to compliment four Control 23 speakers.

- 340 watt continuous program power rating
- Slot loaded vented bandpass design
- Not outdoor capable

CONTROL SB210

DUAL 10" INDOOR/OUTDOOR HIGH OUTPUT SUBWOOFER

The Control SB210 subwoofer contains two high power 10" woofers suitable for both indoors and out. Its compact size, durable enclosure, insert points, and stacking options making it one of the most versatile subwoofers on the market.

- 800 watt continuous program power rating
- Fully outdoor capable design
- Integrated M6 inserts for optional U-bracket or suspension

ACCESSORIES

MTC-PC2: The MTC-PC2 Panel Cover provides sealed entrance protection for input terminals and strain relief for incoming speaker wire.

MTC-xxSSG and MTC-xxWGM: SSG stainless steel retrofit grilles for Control 23, 25, and 28. WGM WeatherMax™ grilles add a foam and tight-weave backing to break up driving rain.

MOUNTING BRACKETS

MTC-xxUB*: U-brackets for installing Control 29AV, 30 and SB210. Available in black or white.

MTC-xxH* Horizontal Array Brackets: Allows horizontal arraying of two Control 23, 25 or 28 speakers. MTC-H brackets can be interconnected to form a suspended ring for mounting 6 or 3 speakers in a 360° cluster module.

MTC-xxV* Vertical Array Brackets: Allows vertical end-to-end mounting of up to three Control 23, 25, or 28 speakers.

MTC-xxCM* Ceiling Brackets: The curved arm allows installation of Control 23, 25, 28, 29AV or 30 speakers down from a ceiling.

MTC-30MK-WH: Marine grille kit for Control 30 (white only).

SB-2 Installation Brackets: The MTC-SB2W wall/corner bracket allows mounting of the subwoofer onto a wall surface or into a corner. The MTC-SB2C ceiling bracket enables suspension of the SB-2 from above, projecting downward into the listening area.

PMB-BK and PMB-WH: Control CRV pole-mount bracket for 4-speaker 360° hanging pendant cluster.

Various adaptors for installing via threaded pipe or rod available from third party. Contact JBL for information.

* These models are available in different sizes. Specify speaker model when ordering.



CONTROL 29AV-1 CONTROL 30-WH



CONTROL SB2

CONTROL SB210

CONTROL® CONTRACTOR

EASY TO INSTALL IN-WALL SPEAKERS



126W/WT

128W/WT

The Control 100 Speakers are premium in-wall speakers designed for applications where top performance from a loudspeaker with minimal visual impact is required. The Control 100 Series speakers are voiced similarly to other JBL control Contractor models, allowing mixing with surface-mount and in-ceiling speakers within a single listening space. The premium sound quality makes these loudspeakers ideal for critical listening environments, yet they are high power and rugged enough to handle venues requiring high-SPL heavy duty-cycle music.

CONTROL 126W/WT and CONTROL 128W/WT

PREMIUM IN-WALL HIGH PERFORMANCE SPEAKERS

The Control 126W and Control 128W feature high performance woofers with a polymer coated aluminum cone, pure butyl rubber surround for long life and high reliability, and extended polepiece magnet design for long excursion and high reliability. The pure titanium dome high frequency driver is loaded with a built-in EOS™ (Elliptical Oblate Spheroidal) waveguide for low distortion and a smooth frequency response. A low-diffraction swivel mounting system enables the user to direct high frequencies where required without the diffraction distortion inherent in other aimable tweeter designs. A high-slope crossover network maintains natural midrange sound and produces more even coverage throughout the listening area.

The Control 126W has a 6.5" woofer and 1" titanium dome tweeter. The Control 128W has an 8" woofer and 1" titanium dome tweeter. Both are ideal for critical listening applications where top performance and minimal visual impact is required.

The speakers fit into the wall space of ordinary stud-wall construction. An optional rough-in frame is available for installing the speakers into standard stud walls in new construction projects. As is the case with all Control Contractor speakers, the baffles and grilles are paintable to match any décor.

The optional Control 126WT and Control 128WT include 70V/100V transformers for use on distributed loudspeaker lines.

- 200 watt continuous power rating
- High-slope crossover for natural midrange sound
- Includes cutout template & paint shield

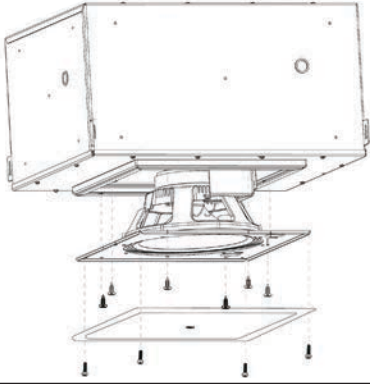

CONTROL® 300 SERIES

LARGE FORMAT CEILING SPEAKERS

Control 300 Series represents the state of the art in large-format ceiling loudspeaker systems. True point-source coax designs, multiple power levels and transformer choices, plus an in-ceiling subwoofer, make it easy to fulfill any system performance requirements. Premium components include Kevlar-reinforced cones, low-saturation transformers and legendary JBL compression drivers. Advanced high-slope crossover networks, combined with low system distortion and smooth frequency response provides full, natural music along with exceptional speech intelligibility.

CONTROL 328C & 328CT

8" COAXIAL CEILING LOUDSPEAKER

The Control 328C has a 8" woofer and 1" compression driver engineered from the ground up to deliver exceptional performance in a coaxial point source design ceiling speaker. The optional Control 328CT includes 70V/100V multi-tap transformer.

- 250 watt continuous power rating
- Excellent clarity for speech and vocals
- Consistent 120° broadband pattern control

CONTROL 321C & 321CT

12" COAXIAL CEILING LOUDSPEAKER

The Control 321C has a 12" woofer and 1" compression driver engineered from the ground up to deliver exceptional performance in a coaxial point source design ceiling speaker. The optional Control 321CT includes 70V/100V multi-tap transformer.

- 250 watt continuous power rating
- Excellent clarity for speech and vocals
- Consistent 90° broadband pattern control

CONTROL 322C & 322CT

HIGH OUTPUT 12" COAXIAL CEILING LOUDSPEAKER

The Control 322C has a high output 12" woofer and 1" compression driver engineered from the ground up to deliver exceptional performance in a coaxial point source design ceiling speaker. The optional Control 322CT includes 70V/100V multi-tap transformer.

- 400 watt continuous power rating
- Excellent clarity for speech and vocals
- Consistent 90° broadband pattern control

CONTROL 312CS

HIGH OUTPUT 12" CEILING LOUDSPEAKER

The Control 312CS is a high output 12" subwoofer that is an excellent addition to JBL Control 321, 322, and 328 loudspeaker systems.

- 400 watt continuous power rating
- Kevlar reinforced 12" woofer
- Clean contemporary grille and optional back box

ACCESSORIES

Premium accessories include best-in-class back boxes made of heavy 16 gauge metal and lined with 1/2" MDF, as well as contemporary grilles and an optional higher power transformer. A variety of grilles. Please visit our website for more information.





CONTROL 226C/T

Control 200 models are available both in an independent backcan design (Control 227C & 227CT) and in an integrated backcan version (Control 226C/T).

CONTROL® 200 SERIES

MEDIUM FORMAT CEILING SPEAKERS

Control 226C/T, 227C and 227CT are premium in-ceiling speakers designed to meet the increasing market demand for premium quality sound in ceiling-mount applications. The Control 200 Series loudspeakers incorporate breakthrough performance features such as best-in-class pattern control to provides a consistent sound throughout the listening area. Especially wide coverage allows fewer speakers to cover the space, reducing both the material and labor cost for the installation. The high-power kevlar-reinforced 6.5 in (165 mm) low-frequency driver along with the titanium-diaphragm compression driver and the advanced-technology steep-slope crossover provide superb, wide-bandwidth sound quality.

Control 226C/T

6.5" COAXIAL CEILING LOUDSPEAKER

Control 226C/T is a compact, easy-to-install speaker with integrated backcan for blind-mounting into ceilings. It features a top-quality 60W multi-tap transformer for 70V/100V line distribution systems. The transformer may be bypassed, allowing the Control 226C/T to be used as a low-impedance 8 ohm speaker. C-ring, tile rails and grille are included. This model is designed to be able to utilize the optional MTC-19NC new construction ring and MTC-19MR plaster-ring for new construction projects requiring pre-installation rings.

- 150 watt continuous power rating
- Excellent clarity for speech and vocals
- Consistent 120° broadband pattern control

Control 227C & 227CT

6.5" COAXIAL CEILING LOUDSPEAKER

Control 227C is a high-output, low-impedance 8 ohm speaker assembly for installation with the separate MTC-200BB8 backcan and MTC-RG6/8 grille (both sold separately). Optional accessories include MTC-19NC new construction ring, MTC-19MR plaster-ring, and MTC-TB6/8 tile bridge. **Control 227CT** is a 70V/100V version of Control 227C, featuring a top-quality 60W multi-tap transformer for 70V/100V line distribution systems.

- 150 watt continuous power rating
- Excellent clarity for speech and vocals
- Consistent 120° broadband pattern control

PREMIUM ACCESSORIES

MTC-200BB6: Backcan for Control 227C and 227CT. 13.3 inches (337 mm) max diameter x 8.1 inches (206 mm) deep.

MTC-RG6/8: Round grille for Control 227C and 227CT. Also fits Control 328C & 328CT. 13.6 inches (345 mm) in diameter

MTC-SG6/8: Square grille for Control 227C and 227CT. Also fits Control 328C & 328CT. 13.4 inches (340 mm) x 13.4 inches (340 mm).

MTC-TB6/8: Tile bridge for Control 227C and 227CT. Also fits Control 328C & 328CT.

MTC-19NC & MTC-19MR: New-construction and mud rings fit Control 226 for new construction applications requiring pre-installation rings.



CONTROL 227C & 227CT Assembly with Backcan and Grille

CONTROL 227C

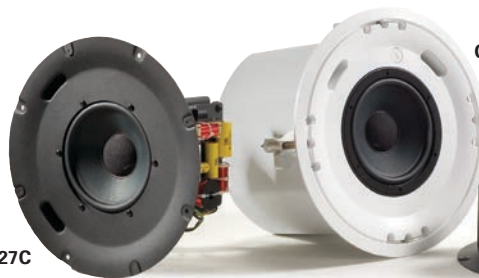

CONTROL 226C/T



CONTROL 227CT





CONTROL 45C/T
Shown without grille

CONTROL® 40 SERIES

EXTENDED PERFORMANCE SMALL FORMAT CEILING SPEAKERS WITH CONICAL RBI

The Control 40 Series Ceiling Speakers are designed to work perfectly in environments that require a premium, in-ceiling speaker with an extremely wide bandwidth and consistent coverage. Consisting of three 6.5" coaxial models, a 2.5" ultra-compact satellite speaker and in-ceiling subwoofer, the Control 40 Series can be configured in many different ways to accommodate a full range of applications. JBL focused on ease-of-installation by including an integrated backcan, grille and tile rails (except Control 42C), locking 2-pin connectors and two knockouts. The Control 40 Series speakers are designed for use in air handling spaces.

CONTROL 47C/T & CONTROL 47LP

6.5" COAXIAL CEILING LOUDSPEAKER

The Control 47C/T and Control 47LP are designed for applications that require extremely wide bandwidth and very consistent coverage. The Control 47LP (Low Profile Backcan) is identical to the Control 47 but equipped with a shallow backcan for use in areas with restricted mounting depths.

- 150 watt continuous program power rating (8 ohm)
- 8 ohm and 70V/100V operation
- Consistent 120° broadband pattern control

CONTROL 47HC

6.5" COAXIAL CEILING LOUDSPEAKER

The Control 47HC is designed for applications that require a narrow focused beamwidth pattern and very consistent coverage, such as for increasing clarity, intelligibility and SPL when in high-ceiling applications.

- 150 watt continuous program power rating (8 ohm)
- 8 ohm and 70V/100V operation
- Narrow 75° coverage pattern

Control 45C/T

5.25" COAXIAL CEILING LOUDSPEAKER

The Control 45C/T is a premium loudspeaker designed for applications that can benefit from extremely wide bandwidth and very consistent coverage from a ceiling speaker with a small footprint.

- 150 watt continuous program power rating (8 ohm)
- 8 ohm and 70V/100V operation
- Consistent 120 broadband pattern control

CONTROL 42C

2.5" ULTRA COMPACT SATELLITE SPEAKER

The Control 42C is an ultra-compact in-ceiling satellite loudspeaker designed for use with the Control 40CS/T subwoofer. It offers an unobtrusive design which is ideal for a wide range of installations.

- 30 watt continuous program power rating
- Small unobtrusive design
- High fidelity sound for subwoofer-satellite systems

CONTROL 40CS/T

8" HIGH IMPACT CEILING SUBWOOFER

The Control 40CS/T is a direct radiating, high impact 8" subwoofer designed for powerful bass response in an in-ceiling loudspeaker. It features a built in crossover network and four high-passed outputs enabling it to be used as a sub/sat system.

- 100 watt continuous program power rating
- Switchable 70V/100V or Low-z
- Passive crossover network for easy system install



CONTROL 42C

CONTROL 47C/T

CONTROL 47LP
Shown without grille

CONTROL 47HC
Shown without grille

CONTROL 40CS/T
Shown without grille





CONTROL® 20 SERIES

PREMIUM SMALL FORMAT CEILING SPEAKERS

The Control 20 Series ceiling speakers deliver high power handling, overload protection and exceptional sound level capability and are packaged as complete assemblies, including integral backcan, front grille and tile bridge support hardware (except Control 26-DT). Innovative design features such as titanium-coated tweeters and JBL's unique diffraction-horn loading provide broad, even coverage through the listening area.

CONTROL 24C MICRO, 24CT MICRO & 24CT MICROPLUS

4.5" BACKGROUND MUSIC CEILING LOUDSPEAKER

The Control 24C/CT Micro and 24CT MicroPlus are compact and easy to install in-ceiling speakers providing full, high quality sound for background music and music-plus paging systems. The 24CT Micro includes a 9W multi-tap transformer and the 24CT MicroPlus includes a 25W multi-tap transformer.

- 30 watt continuous program power rating (24C Micro)
- Can depth of 4.1" (105mm) for shallow ceiling spaces
- Extremely wide 150° coverage pattern



24C/CT MICRO
24CT MICROPLUS

CONTROL 24C, 24CT & 24CT-BK

4" COAXIAL CEILING SPEAKER

The Control 24C contains a coaxially mounted 4" woofer and 3/4" titanium coated tweeter providing high fidelity sound over a wide coverage area. The 24CT provides a 70V/100V multi-tap transformer. The 24CT is available in black (C24CT-BK).

- 80 watt continuous program power rating
- Extremely wide 130° coverage pattern

CONTROL 26C, 26CT & 26CT-LS

6.5" COAXIAL CEILING SPEAKER

The Control 26C contains a coaxially mounted 6.5" woofer and 3/4" titanium coated tweeter, able to deliver maximum sound level over a defined area. The 26CT provides a 70V/100V multi-tap transformer. The 26CT-LS is UL1480/UUMW life-safety certified.

- 150 watt continuous program power rating
- Extremely wide 110° coverage pattern

CONTROL 26-DT

6.5" COAXIAL CEILING SPEAKER

The Control 26-DT is an 6.5" coaxial ceiling speaker designed to fit into a standard 8" ceiling speaker backcan. A high quality transformer is included for 70V/100V distributed lines.

- 60 watt transformer for 70V/100V distributed lines
- 90° nominal coverage angle



26-DT

CONTROL 19CS & 19CST

8" CEILING SUBWOOFER

The Control 19CS uses advanced technology to produce powerful bass from a low profile ceiling speaker. The optional 19CST has a special subwoofer band transformer for 70V/100V operation.

- 200 watt continuous program power rating
- Simple installation and wire connecting method
- Low frequency response down to 42Hz (-10dB)

ACCESSORIES

New Construction Bracket: MTC-xxNC*
Plaster Ring Bracket: MTC-xxMR*

Trim Rings: Allow for installation into existing ceiling speaker cutouts that are larger than the speaker's normal cutout size. MTC-xxTR*.

MTC-48TRx12: Tile Rails for 4' x 4' ceiling tiles (pack of 12 rails)

* These models are available in different sizes. Specify speaker model when ordering.



CONTROL 12C/T-BK
Shown without grille

CONTROL® 10 SERIES

AFFORDABLE BLIND-MOUNT CEILING SPEAKERS

Control 10 Series in-ceiling loudspeakers meet the increased market demand for superior sound quality, installation-friendly features and value, delivering a level of sonic performance unmatched by comparably priced products. They are ideal for applications where excellent sound quality is needed for medium-volume music playback and paging.

Control 10 Series models feature wide bandwidth, wide coverage, and combined 70V/100V and 8 ohm operation in each speaker. Dual conduit clamp allows separate strain reliefs for the input and loop out cables. Available in either white or black (-BK).

CONTROL 12C/T

3" FULL-RANGE COMPACT CEILING SPEAKER

The Control 12C/T is a high fidelity speaker with a 3" full-range driver and a wide frequency range of 68 Hz to 17 kHz. The short (4.7in./120mm) blind-mount backcan allows easy installation in shallow ceiling spaces.

- 40 watt continuous program power rating
- 130° conical coverage angle
- Max SPL@1m: 97dB average, 103dB peak

CONTROL 14C/T

4" TWO-WAY COAXIAL CEILING SPEAKER

The Control 14C/T contains a co-axially mounted 4" woofer and ¾" soft dome tweeter. The liquid-cooled soft dome tweeter provides clear, pleasant sound over a wide coverage area. Blind-mount backcan for quick and easy installation.

- 60 watt continuous program power rating
- 120° conical coverage angle
- Max SPL@1m: 102dB average, 108dB peak

CONTROL 16C/T

6.5" TWO-WAY COAXIAL CEILING SPEAKER

The Control 16C/T is the largest Control 10 Series model, containing a co-axially mounted 6-1/2" woofer and ¾" soft dome tweeter. High 91 dB sensitivity allows for high maximum SPL with wide bandwidth. Blind-mount backcan for quick and easy installation.

- 100 watt continuous program power rating
- 110° conical coverage angle
- Max SPL@1m: 108dB average, 116dB peak

ACCESSORIES

New Construction Brackets & Trim Rings: The Control 10 Series speaker utilize the Control 20 Series NC New Construction Brackets, MR Plaster Ring Brackets, and TR Trim Rings.

Control 12C/T and 14C/T utilize MTC-24NC, MR & TR.

Control 16C/T utilizes MTC-26NC, MR & TR.

MTC-48TRx12: Tile Rails for 4' x 4' ceiling tiles (pack of 12 rails).



Each speaker is equipped with a selector for 100V, 70V or 8 ohm direct operation.

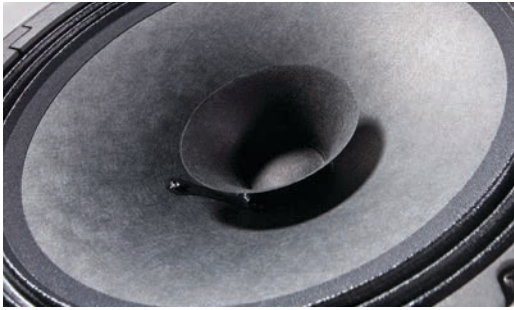

The 8124 4-inch (100 mm) full-range loudspeaker and the two 8-inch (200 mm) full-range loudspeakers feature high sensitivity drivers that deliver maximum sound levels using minimal amplifier power. (8128/8138 shown)

8100 SERIES

SCULPTED GRILLE DUAL-CONE CEILING SPEAKERS

High sensitivity at a cost-effective price point, the 8100 Series is an easy to install loudspeaker solution for a wide variety of commercial sound applications. With its contemporary grill design, the 8100 Series loudspeakers are ideal for a variety of settings ranging from restaurant and retail settings to professional offices and reception areas. All models feature 6 watt transformer for 70V/100V distributed lines.

8124

4" FULL-RANGE CEILING SPEAKER

The 8124 is a 4-inch (100 mm) full-range loudspeaker, featuring a high sensitivity driver that provides 130° conical coverage in a lightweight (2.5 lb) package.

- Frequency response (-10dB): 60 Hz -18 kHz
- Dog-ears for easy Blind Mount installations
- For areas not requiring backcan

8128

8" FULL-RANGE CEILING SPEAKER

The 8128 is an 8-inch (200 mm) full-range loudspeaker, featuring a high sensitivity driver that provides 90° conical coverage in a lightweight (3.0 lb) package.

- Frequency response (-10dB): 50 Hz -16 kHz
- Dog-ears for easy Blind Mount installations
- For areas not requiring a backcan

8138

8" FULL-RANGE CEILING SPEAKER

The 8138 is an 8-inch (200 mm) full-range loudspeaker designed for use with MTC-BB8 pre-install in-ceiling backcan, resulting in high sensitivity performance at a cost effective price point.

- Frequency response (-10dB): 95 Hz -18 kHz
- Installs to in-ceiling backboxes with 4 mounting points on an 11.25" mounting circle
- Clear, high-fidelity performance when used in JBL pre-install backcan

ACCESSORIES

Because of the very light weight of 8124 and 8128, tile rails may not be required for some in-ceiling applications. They are not packaged with these models, however MTC-RAIL tile rail sets and MTC-8124C and MTC-8128C C-Rings are available separately. The 8138 is designed for use with MTC-81BB8 backcan and MTC-81TB8 tile bridge.

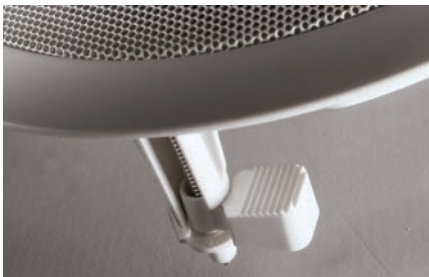

The 8124 and 8128 Ceiling Speakers are designed with built-in dog-ears for fast and easy installations, and are lightweight with open-back design for applications not requiring an in-ceiling backcan.



The 8100 Series is equipped with a contemporary grille, allowing the speakers to blend with a variety of interiors.





COMMERCIAL SOLUTION SERIES

CSS CEILING AND SURFACE-MOUNT SPEAKERS

The JBL Commercial Series provides affordable performance for paging and background music applications in retail stores, restaurants, schools and other facilities.

CSS8004

4" COMMERCIAL CEILING SPEAKER

The CS8004 is a 4" ceiling speaker designed for paging and background music applications. High sensitivity across the product line provides maximum sound level, even at low tap settings.

- 30W continuous program power rating
- 5W multi-tap transformer for 25V/70V/100V operation
- Very wide 175° coverage pattern

CSS8008

8" COMMERCIAL CEILING SPEAKER

The CS8008 is a 8" ceiling speaker designed for paging and background music applications. High sensitivity across the product line provides maximum sound level, even at low tap settings.

- 30W continuous program power rating
- 5W multi-tap transformer for 25V/70V/100V operation
- Very wide 120° conical coverage pattern

CSS8018

8" COMMERCIAL CEILING SPEAKER

The CS8018 is a 8" ceiling speaker designed for paging and background music applications. High sensitivity across the product line provides maximum sound level, even at low tap settings.

- 40W continuous program power rating
- 10W multi-tap transformer for 25V/70V/100V operation
- Very wide 110° conical coverage pattern

ACCESSORIES FOR CSS8004, CSS8008 and CSS8018

MTC-BB4x6: Pre-install backcan for CSS8004. Pack of 6 pcs.

MTC-BB8x6: Pre-install backcan for CSS8008 and CSS8018. Pack of 6 pcs.

MTC-TR4/8x12: Tile rails for CSS-BB4 and CSS-BB8 backcans. Pack of 12 pcs. for 6 speakers.

CSS-1S/T

5.25" COMPACT TWO-WAY LOUDSPEAKER

The CSS-1S/T is a versatile, compact two-way loudspeaker designed for use on 100V or 70V distributed speaker lines or in 8 ohm direct mode. Aimable wall-mount bracket is included.



CSS-1S/T

- 60W continuous program power rating
- 10W multi-tap transformer for 70V/100V operation
- 120° x 120° coverage pattern

CSS-H15 / CSS-H30

15 WATT / 30 WATT PAGING HORNS

The CSS-H15 and H30 paging horns provide excellent voice range clarity. The wide coverage pattern allow the horns to cover larger audience areas, and they are designed for demanding environmental conditions.



CSS-H15 / CSS-H30

- 15W or 30W continuous program power rating
- 15W or 30W multi-tap transformer for 70V/100V operation
- 70° x 90° (H15) or 50° x 70° (H30) coverage pattern

INTELLIVOX

DIGITALLY CONTROLLABLE, BEYOND BEAM STEERING

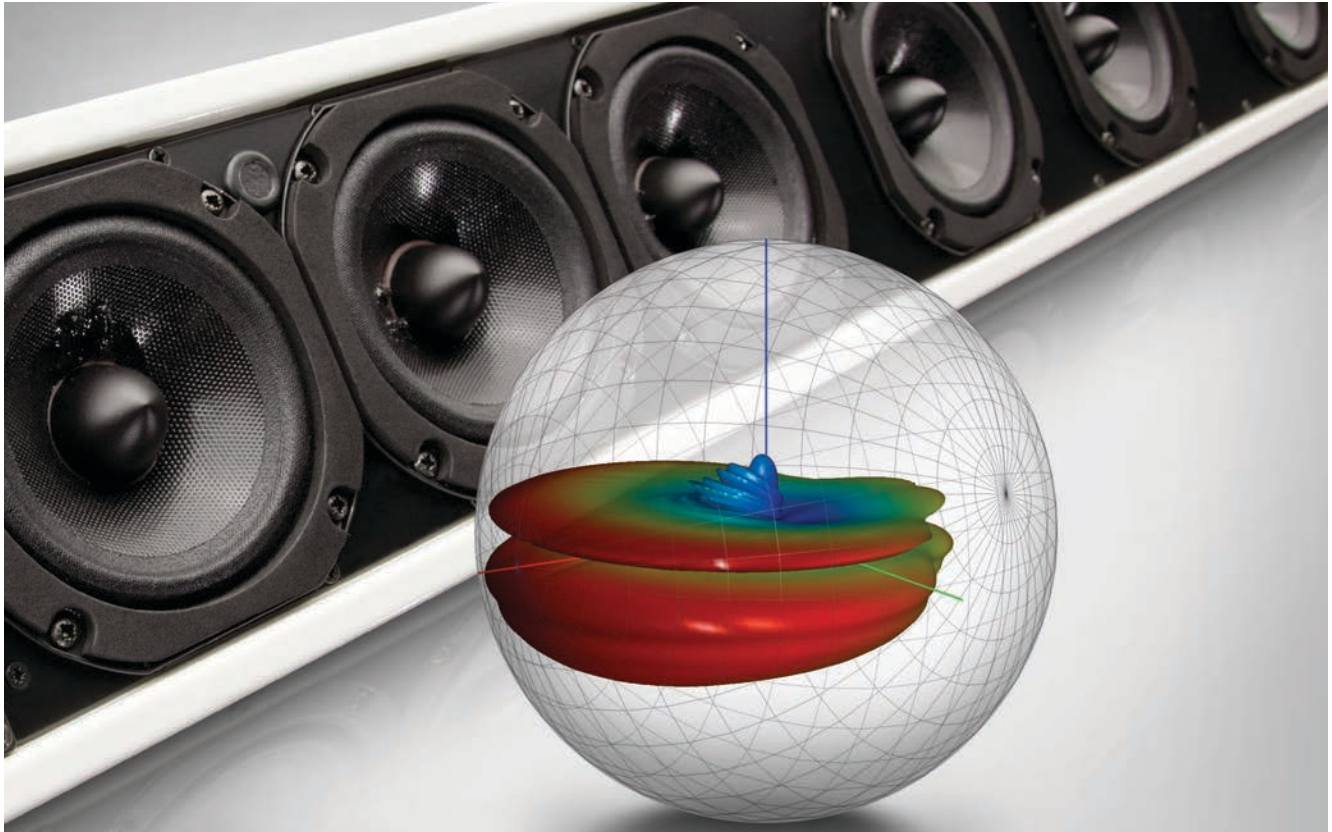

INTELLIVOX
COMMERCIAL SOUND PRODUCTS

The biggest challenge facing a sound system designer is devising a system which will have a high direct to reverberant sound ratio, maximizing the sound that arrives directly to the listeners ear, while reducing the sound energy from walls, ceilings and other acoustically reflective surfaces. With the Intellivox DDC (Digital Directivity Control), DDS (Digital Directivity Synthesis) technologies, and WinControl software it's possible to control the vertical directivity pattern of Intellivox products and aim the sound where you want it - at the listener.

The standard Intellivox DC and DS column speakers are 134mm wide, 92 mm deep and available in 6 lengths. 1150mm, 1800mm, 2800mm, 3800mm, 4300mm and 5000mm. The longer the array, the more control you have over the directivity. They each have an array of 4 inch drivers with built in amplification and DSP. The DC/DS 115 has 2 additional tweeters to extend the frequency range.

The Intellivox DSX products have the same dimensions as their DC/DS equivalent, and include a small horn array, extending the frequency response to 18 kHz.

For an even wider frequency range we also manufacture the DC/DS 808 and 1608 with 6.5 inch drivers, making the speakers better suited to Music as well as speech. The electronics module for these units comes separated in a 3RU enclosure.



INTELLIVOX DC & DS FAMILIES

DC115 DS115 DC180 DS180 DC280 DS280 DC380 DS380 DC430 DS430 DC500 DS500 DC808 DS808 DC1608 DS1608

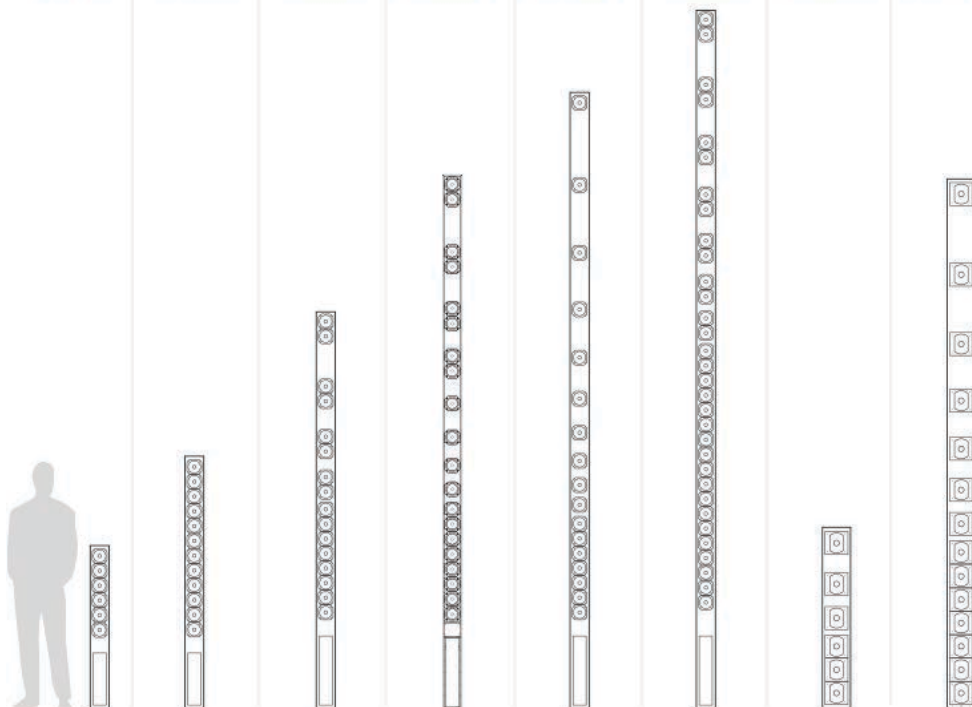

INTELLIVOX DSX FAMILIES

DSX180 DSX280 DSX380 DSX430 DSX500

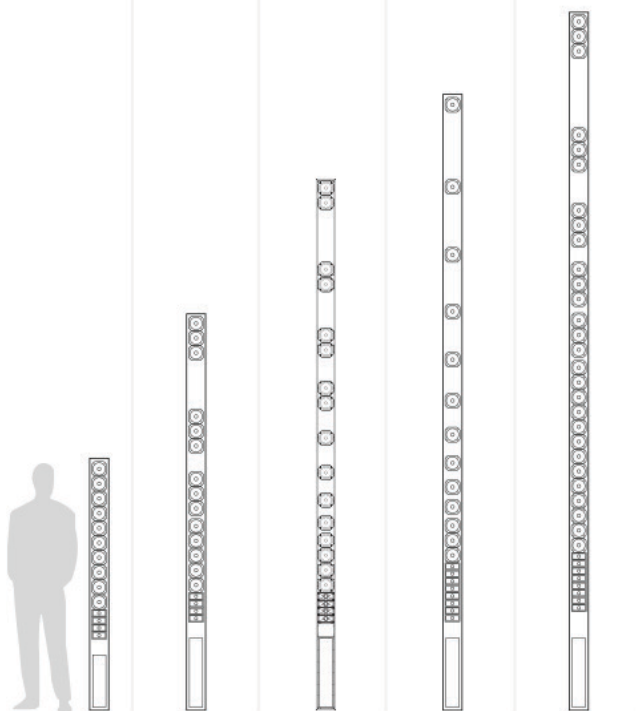

INTELLIVOX
COMMERCIAL SOUND PRODUCTS





M2 Master Reference Monitors at The Village Studios, Los Angeles, CA

STUDIO MONITORS

SMOOTH ACCURATE RESPONSE AT THE MIX POSITION

JBL Studio Monitors go “beyond accurate” all the way to “stunning” by incorporating features that reduce the effect of problems in the room. We start with the latest JBL transducer and network technologies for ultra-flat response and exceptional dynamic range. Then we incorporate features that optimize monitoring accuracy in your workspace. So even if you work in a small home studio, you’ll have clear sound at the mix position. All models in the line are engineered for use in the most demanding production environments. With JBL Studio Monitors mixing is a pleasure.

JBL PROFESSIONAL IS THE PROUD RECIPIENT OF THE 2005 TECHNICAL GRAMMY®

The National Academy Of Recording Arts and Sciences Presented the 2005 Technical GRAMMY® Award to JBL Professional for Continual Mastery and Innovation in Concert, Studio, Cinema and Broadcast Sound and Monitors to Ensure Exacting Standards for the Most Accurate Sonic Experience.

Linear Spatial Reference (LSR) Technology

Much of what you hear at the mix position is reflected - not direct sound. LSR Technology ensures mid and high frequency response of our speakers is neutral at the mix position. As a result, the reflected sound that reaches the mix position is smooth and accurate.

Stunning Sound

Starting with application-designed and built transducers engineered for extremely accurate response and superb power handling, the stunning sound of the JBL Studio Monitors makes long mix sessions a pleasure. Meeting higher standards than any other loudspeaker manufacturer, JBL's demanding tests ensure that our speakers give you accurate mixes year after year.



M2 MASTER REFERENCE MONITOR

THE NEW STANDARD OF ACCURACY AND PERFORMANCE

Until now, the impressive large-format monitoring experience has been unattainable in small and medium-size rooms. With the introduction of the M2 Master Reference Monitor, JBL brings world-class large-format monitoring to a broad range of production spaces. Leveraging a new generation of high-output, ultra-low distortion JBL transducers, the M2 provides an in-room response of 20 Hz to 40 kHz, with the high SPL and dynamic range required for demanding music and film production. The M2's revolutionary Image Control waveguide ensures stunning imaging across a wide listening area. With a footprint of only 14 inches deep and 20 inches wide, the M2 two-way system outperforms many larger and more costly 3-way and 4-way systems, making big, detailed sound an option for artist studios, mastering facilities, small mix stages and screening rooms.



M2 (shown with removable grille)

D2 Dual-Diaphragm Dual Voice Coil Compression Driver

The D2 high-frequency compression driver in the M2 provides smooth extended high frequency response to 40 kHz, with extraordinary output and ultra-low distortion. The advanced Image Control waveguide produces remarkable imaging, neutral broad-band in-room response and enhanced high-frequency coverage.



2216ND Differential Drive Low Frequency Transducer

The 2216ND is made with two neodymium magnets and dual voice coils employing patented low thermal coefficient of resistance wire. This allows very high output with minimal power compression, resulting in deep distortion-free bass even at very high SPL.



Crown Power

The M2 System is bi-amplified and tuned with Crown iTech 5000HD or iTech4x3500HD amplifiers for unmatched power and transient response. Multiple systems can be networked and centrally controlled using Harman System Architect™ Software. Optional configurations include BSS Soundweb™ London signal processing and I/O. Each speaker can be calibrated and optimized for room placement and acoustics.



M2 MASTER REFERENCE MONITOR
STUDIO MONITORS





7 SERIES

NEXT GENERATION MONITORING DEVELOPED FROM THE GROUND UP FOR POST AND BROADCAST FACILITIES.

JBL's new 7 Series Studio Monitors answer the call for next generation multi-channel monitoring in post and broadcast production control rooms. Leveraging patented technologies developed for JBL's flagship M2 Master Reference Monitor, 7 models deliver detailed imaging, extended frequency response and remarkable output from compact enclosures. Centrally amplified and tuned, and easily installed, 705i and 708i Studio Monitors are the heart of an elegant, scalable system for broadcast and post facilities working in 5.1, 7.1 surround sound and immersive audio formats.

Next Generation Transducers

Meeting the dynamic range and extended frequency response requirements of today's production formats, 7 Series models leverage JBL next generation ultra-low distortion drivers that deliver extraordinary output and remarkable frequency response.



Patent-Pending Image Control Waveguide

First introduced in the JBL M2 Master Reference Monitor, the Image Control Wave Guide technology delivers detailed imaging, neutral response in the critical dialog range, and greater room-to-room consistency.



Centrally Processed and Amplified

The system is centrally processed and powered leveraging the superb performance and high density of eight channel Crown power amps and BSS Soundweb London Processors. Centralized electronics eliminate the expense of providing power outlets at each speaker location and allow comprehensive system control and tuning

Compact, Install-Friendly Enclosures

- Compact front-ported enclosures are designed to minimize interference with sight lines and reduce the impact on available space
- Integrated mounting points and a range of mounting options allow the 705i and 708i to go where others can't

Next Generation Scalable Systems for any size Post or Broadcast control room

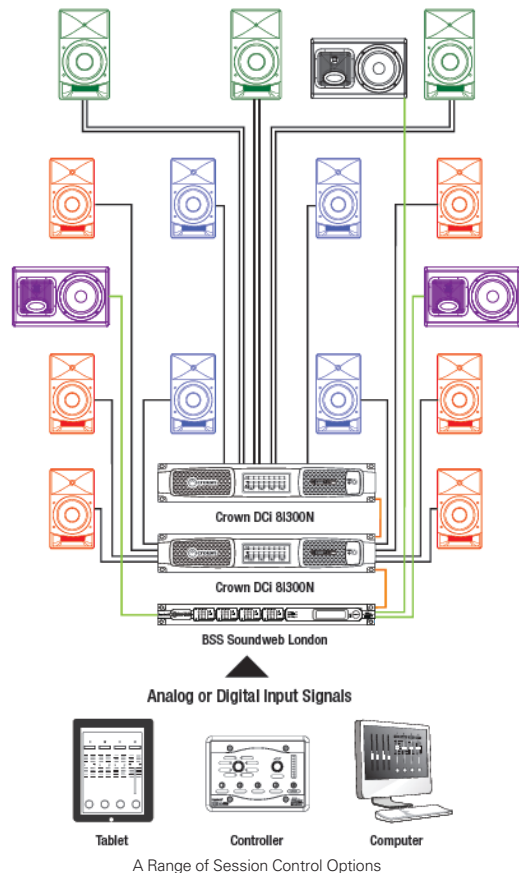

7 SERIES STUDIO MONITORS



LSR708i

8" TWO-WAY STUDIO MONITOR

- RESPONSE -1.5 dB @ 45 – 23kHz
- FREQUENCY RANGE 35Hz – 36 kHz
- MAX SPL (80 Hz - 20 kHz) >108 dB SPL / 1m

Dimensions (H x W x D): 17.25 x 9.75 x 11 in.
(438 x 248 x 280 mm)



LSR705i

5" TWO-WAY STUDIO MONITOR

- RESPONSE -1.5 dB @ 45 – 23kHz
- FREQUENCY RANGE 39Hz – 36 kHz
- MAX SPL (80 Hz - 20 kHz) >101 dB SPL / 1m

Dimensions (H x W x D): 10.5 x 5.875 x 8.125 in.
(267 x 149 x 206 mm)



LSR6300 SERIES

EXCEPTIONAL ACCURACY AND PERFORMANCE

The award-winning JBL LSR6300 Series professional loudspeakers deliver the exceptional accuracy and performance needed in demanding music, post audio and broadcast applications. Each model provides ultra-flat response, extraordinary SPL capability and technology to optimize performance in any size production environment. All models are shielded, ready for mounting and THX pm3[®] approved.



LSR6325P-1

COMPACT POWERED 5.25" TWO-WAY STUDIO MONITOR

The LSR6325P-1 provides exceptional performance for use in applications where accuracy is a must, but space is limited. With a 5.25" high-excursion woofer, 1" damped titanium composite tweeter, and 150 watts of amplification, it outperforms many larger systems.



- Peak SPL of 109dB
- Front panel volume and power controls
- Integrated mounting points

LSR6328P

8" POWERED TWO-WAY STUDIO MONITOR

The LSR6328P is the choice for stereo and multi-channel music and post audio applications where accuracy and high SPL are required. With ruler flat response from 50 Hz to 20 kHz, low frequency extension to 36 Hz, boundary compensation and JBL's new RMC system, the LSR6328P gives you exceptional low frequency performance in any room.



- Peak SPL of 111dB
- Differential Drive technology for extended low frequency response
- Integrated mounting points for installation

LSR6332

12" PASSIVE HIGH SPL THREE-WAY STUDIO MONITOR

The LSR6332 is the ideal choice if you need a larger monitor with high SPL for mid-field, soffit or behind the screen applications. This three-way non-powered system features a 12" Differential Drive woofer, 5" Kevlar midrange speaker, and 1" titanium composite tweeter.



- Peak SPL of 112dB
- Differential Drive technology with dynamic braking
- Rotatable sub-baffle for horizontal or vertical orientation

LSR6312SP

12" POWERED SUBWOOFER

The LSR6312 powered subwoofer is based on a 12" Differential Drive woofer and 260 watts of power. An integral bass-management system provides all the features you need for today's multi-format surround production. JBL's RMC Calibration Kit included.



- Peak SPL of 115dB
- Sophisticated LCR bass management system
- Direct LFE input with selectable input sensitivity

LSR4300 SERIES



LSR4300 SERIES
STUDIO MONITORS



LSR4328P

8" POWERED TWO-WAY STUDIO MONITOR

The LSR4328P is a bi-amplified system with a 8" woofer and a 1" silk-dome tweeter. It also features JBL's exclusive RMC Room Mode Correction that analyzes and corrects the response of each speaker in the room for absolute accuracy at the mix position.

- Peak SPL of 112dB
- Convenient mounting points for mounted installation
- Integrated handles for ease of positioning



System calibration is accomplished by simply plugging the LSR4300 calibration microphone into the speaker and pushing a button.

LSR4300 Accessory Kit includes:



- LSR4300 Calibration Mic and mic clip
- Remote Control
- LSR4300 Control Center Software
- USB Cable

Included in the LSR4328P/PAK



LSR310S

LSR305

LSR308

3 SERIES

EXCEPTIONAL PERFORMANCE REMARKABLE IMAGING
PRICED WITHIN REACH OF ANY STUDIO

The 3 Series Powered Studio Monitors are the first to incorporate JBL's groundbreaking Image Control Waveguide from our flagship M2 Master Reference Monitors. Unprecedented detail, imaging and depth clearly reveal micro-dynamics in reverb tails, subtleties of mic placement, and a tangible sense of a center channel speaker. A broad, room-friendly sweet spot ensures equal dimension and transparency for everyone in the room. With legendary JBL transducers and custom-designed power amplifiers, the 3 Series will boost the image in your studio.

LSR305

5" Two-Way Powered Monitor

- Frequency range : 43 Hz - 24 kHz
- Max Peak SPL : 108 dB
- Amplifier Power : 80 w

LSR308

8" Two-Way Powered Monitor

- Frequency range : 37 Hz - 24 kHz
- Max Peak SPL : 112 dB
- Amplifier Power : 100 w

LSR305

5" TWO-WAY POWERED MONITOR

Bi-amplified studio monitor with magnetically-shielded 5" low frequency transducer and 1" soft-dome high frequency transducer and Image Control Wave Guide. Class-D 41 watt RMS amplifier for LF, and 41 watt RMS amplifier for HF.

LSR308

8" TWO-WAY POWERED MONITOR

Bi-amplified studio monitor with magnetically-shielded 8" low frequency transducer and 1" soft-dome high frequency transducer and Image Control Wave Guide. Class-D 56 watt RMS amplifier for LF, and 56 watt RMS amplifier for HF.

LSR310S

10" POWERED STUDIO SUBWOOFER

Down-firing high excursion subwoofer system with a 10" woofer and JBL's patented Slip Stream port which deliver impressive low frequency extension and output. Class-D 200 watt RMS amplifier. A JBL first, the included XLF Extended Low Frequency setting lets you hear your tracks with the augmented bass tuning used in today's dance clubs.

CONTROL® MONITORS

COMPACT PROFESSIONAL INSTALLATION MONITORS

The JBL Control Series speakers offer well balanced sound and exceptional power handling, making these speakers ideal for any installation requiring professional control monitor performance from a compact source.



CONTROL 1 PRO



CONTROL 1 PRO-WH

CONTROL 1 PRO

COMPACT 5.25" PASSIVE TWO-WAY LOUDSPEAKER SYSTEM

The Control 1 Pro is a high-performance compact loudspeaker system incorporating monitor-grade, magnetically shielded transducers, a professional crossover network and full-range SonicGuard overload protection.

- 80 Hz to 20 kHz Frequency Range
- Includes mounting bracket
- Available in black or white finishes



CONTROL 2P

CONTROL 2P

COMPACT 5.25" POWERED TWO-WAY LOUDSPEAKER SYSTEM

The Control 2P compact powered reference monitor system combines JBL's legendary loudspeaker design with powerful amplification to deliver rich, accurate performance for demanding audio applications.

- 80 Hz - 20 kHz Frequency Range
- Stereo headphone jack for headphone monitoring
- Can be wall mounted with optional MTC-2P kit

CONTROL 5

COMPACT 6.5" PASSIVE TWO-WAY LOUDSPEAKER SYSTEM

The Control 5 is a high-performance, wide range control monitor suitable for use as the primary sound source in a variety of applications. All transducers are magnetically shielded for use in close proximity to video monitors.

- Molded enclosure with shielded magnet structure
- 55 Hz - 20 kHz Frequency Range
- Available in black or white finishes



CONTROL 5

CONTROL MONITORS
STUDIO MONITORS



SCREENARRAY® SERIES

ULTRA HIGH POWER LARGE FORMAT LOUDSPEAKER SYSTEMS

The 5742 four-way and 5732 three-way Ultra High Power ScreenArray speakers provide extreme power for large format auditoriums and are designed as the ideal large format loudspeaker system. Both systems feature a 150 watt, 4" titanium diaphragm high frequency driver on JBL's patented Optimized Aperture waveguide.

- THX® approved
- Ultra high power for large auditoriums
- Both 3-way and 4-way speakers



5742



5732

SCREENARRAY SERIES
CINEMA LOUDSPEAKER SYSTEMS



5742
(Rear View)



5732
(SideView)

5742

DUAL 18" FOUR-WAY CINEMA LOUDSPEAKER SYSTEM

The 5742 quad-amplified system features true four-way design with a quad midrange array of four 8" Differential Drive cone midrange drivers providing 1400 watts of smooth coverage coupled with a dual 18" low frequency section.

- Peak SPL of 136dB
- Flat front waveguide for easy baffle wall installation
- Shallow 24" depth for minimum behind-screen depth requirements

5732

DUAL 15" THREE-WAY CINEMA LOUDSPEAKER SYSTEM

The 5732 tri-amplified system is ideal for premier cinemas and post production facilities requiring enhanced power and headroom. The 5732 features a powerful 700 watt midrange section with dual 8" Differential Drive transducers coupled with a dual 15" low frequency section.

- Peak SPL of 128dB
- Flat front waveguide for easy baffle wall installation
- Shallow 18" depth for minimum behind-screen depth requirements

SCREENARRAY® SERIES

THE MOST POPULAR CINEMA LOUDSPEAKERS
THROUGHOUT THE WORLD

With the advent of digital cinema, today's cinema patron is even more demanding of perfect coverage in every seat of the auditorium, wide dynamic range and extended bandwidth and inaudible levels of distortion. Continuing to provide cinema exhibition venues and post production facilities with unprecedented audio performance and advanced technology, JBL introduced the "Next Generation" of its award winning ScreenArray digital cinema loudspeakers. Since their introduction, JBL ScreenArray systems have become the choice for premium cinemas throughout the world. With significant improvements in performance and design, the new ScreenArray systems will continue to be the most popular cinema loudspeakers throughout the world.

JBL offers two ScreenArray systems to meet the challenges posed by lower cost installations. All systems products provide ultra smooth and accurate sound reproduction in a compact and highly cost effective system. The 3722N Passive system and 3722 Bi-amplified system, the 4722N Passive system and the 4722 Bi-amplified system feature the ultra-low distortion ScreenArray high frequency horn with SSC and dual 15" low-frequency sections.



SCREENARRAY SERIES
CINEMA LOUDSPEAKER SYSTEMS

3722 & 3722N

DUAL 15" TWO-WAY CINEMA LOUDSPEAKER SYSTEM

The 3722 and 3722N provide smooth and accurate reproduction of cinema soundtracks in a compact and very cost effective passive system. The system is comprised of two parts: the 3722-HF high frequency pack and the 3739 low-frequency system.

- Peak SPL of 127dB
- 3722 available as passive model with network (3722N)
- High quality in a compact and very cost effective system

4722 & 4722N

DUAL 15" TWO-WAY CINEMA LOUDSPEAKER SYSTEM

The 4722 and 4722N provide smooth and accurate reproduction of cinema soundtracks in a compact and very cost effective passive system. The system is comprised of two parts: the 4722-HF high frequency pack and the 4739 low-frequency system.

- Peak SPL of 130dB
- 4722 available as passive model with network (4722N)
- High quality in a compact and very cost effect system

JBL
PROFESSIONAL
SPEAKERS

SCREENARRAY® SERIES

THE MOST POPULAR CINEMA LOUDSPEAKERS THROUGHOUT THE WORLD

The ScreenArray Series features true three-way system design enhanced by advanced engineering. JBL Professional's best technical innovations are integrated in a system design that provides superior coverage, maximum power handling, and uniform acoustic power output, along with extremely low distortion.

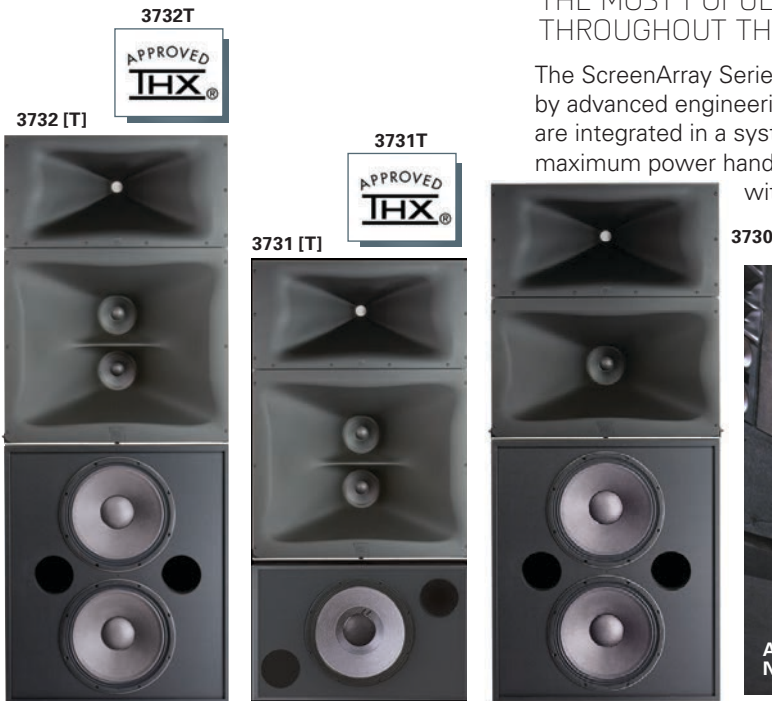

SCREENARRAY SERIES
CINEMA LOUDSPEAKER SYSTEMS

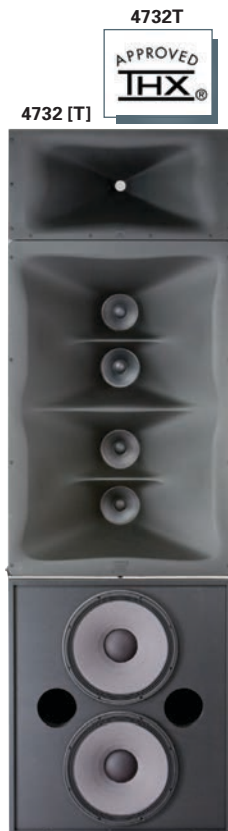

4732 & 4732T

15" THREE-WAY CINEMA SPEAKER SYSTEM
The 4732 and 4732-T feature true three-way system design enhanced for critical film sound reproduction in medium to large cinema environments. The system comes as a bi-amplified (4732) or tri-amplified (4732-T) solution.

- Peak SPL of 130dB
- Second generation Optimized Aperture Waveguide

3732 & 3732T

15" THREE-WAY CINEMA SPEAKER SYSTEM
The 3732 and 3732-T feature true three-way system design enhanced for critical film sound reproduction in small to medium cinema environments. The system comes as a bi-amplified (3732) or tri-amplified (3732-T) solution.

- Peak SPL of 125dB
- Second generation Optimized Aperture Waveguide

3731 & 3731T

15" THREE-WAY CINEMA SPEAKER SYSTEM
The 3731 and 3731-T feature true three-way system design enhanced for critical film sound reproduction in small to medium cinema environments. The system comes as a bi-amplified (3731) or tri-amplified (3731-T) solution.

- Peak SPL of 125dB
- Second generation Optimized Aperture Waveguide

3730

15" THREE-WAY CINEMA SPEAKER SYSTEM
The 3730 provides smooth and accurate reproduction of cinema soundtracks in a compact and very cost effective system.

- Bi-amplified or fully passive switchable operation
- Shallow profile
- Second generation Optimized Aperture Waveguide



5674

JBL STANDARD CINEMA SYSTEMS

COMPACT AND COST EFFECTIVE CINEMA SOLUTIONS

In order to meet the requirements for JBL quality at lower prices, the 3000 and 5000 Series ScreenArray speaker systems were developed. The systems provide smooth and accurate reproduction of cinema soundtracks while being compact and very cost-effective.

The 5674 has earned THX® Approval and is the same system used in The Academy of Motion Picture Arts and Sciences Samuel Goldwyn Theater and The Directors Guild Theater in Los Angeles. The JBL 5674, truly the world's finest three-way loudspeaker.



3252N



3677



3678



Academy of Motion Picture Arts and Sciences, Samuel Goldwyn Theater, Hollywood, California
"Academy Award" and "Oscar" image © AMPAS®. THX® Lucasfilm, LTD.

5674

QUAD 15" THREE-WAY CINEMA LOUDSPEAKER SYSTEM

The 5674 features four JBL 15" low-frequency transducers in a unique DiamondQuad array. This array orientation allows the four drivers to create maximum output, while minimizing destructive interference caused by multiple drivers operating in the same band-pass region.

- Peak SPL of 117dB
- Flat-front design for easy baffle wall installation
- Fully adjustable horn bracket for precise directional control

3252N

DUAL 15" TWO-WAY CINEMA LOUDSPEAKER SYSTEM

The JBL 3252N Screen Channel system provides smooth and accurate reproduction of cinema soundtracks in a compact and cost effective 400 watt system. The convenient single enclosure, featuring dual 15" low frequency drivers and a Teonex diaphragm high frequency driver, requires no field assembly.

- Peak SPL of 124dB
- Fully passive operation
- All in one enclosure for simple installation

3677

15" TWO-WAY CINEMA LOUDSPEAKER SYSTEM

The 3677 combines classic JBL performance with a natural sound quality for both music and dialog. The ideal small system when minimum depth behind the screen is required. For extraordinary convenience, the all-in-one enclosure requires no field assembly.

- 90° x 40° Flat Front Bi-Radial horn
- Shallow cabinet profile minimizes behind screen space requirements
- All in one enclosure for simple installation

3678

15" TWO-WAY CINEMA LOUDSPEAKER SYSTEM

The 3678 is a THX® approved design in the bi-amplified mode. JBL's patented Vented Gap Cooling™ keeps the 2226H low Frequency working optimally while the JBL 2342 Bi-Radial® horn and 2426 pure titanium compression driver ensures a smooth even coverage with natural sound and unsurpassed reliability.

- Flat power response 100° x 100° Bi-Radial® horn
- Operable bi-amp or passive mode.
- Includes adjustable bracket for horn aiming.

CINEMA SURROUND SYSTEMS

SURROUND SOLUTIONS FOR THE MODERN CINEMA

No other manufacturer provides a wider, more cost effective range of surround speaker solutions to meet the demands of modern cinema sound reproduction than JBL Professional.



9320

12" HIGH POWER CINEMA SURROUND

The 9320 Cinema Surround speaker offers high power handling with extended bass response for extended dynamic range required for large format cinemas and multi-channel surround formats. The 9320 is a powerful, two-way full range surround comprised of an M12-8 300mm (12") low frequency driver and a 2408H-1 380mm (1.5") voice coil compression driver. The large format Progressive Transition waveguide provides exceptional 120° x 60° coverage and is rotatable for speaker use in a vertical or horizontal position.

- High power 400 watt, 12" large format cinema surround
- Large PT™ Progressive Transition Waveguide
- 120° x 60° coverage
- Multiple M10 threaded mounting points on top, bottom and sides

SCS 8

8" SPATIALLY CUED CINEMA SURROUND

The SCS 8 is a two-way, full range cinema surround loudspeaker ideal for multi channel surround formats for medium sized auditoriums. The SCS 8 is comprised of a high-power coaxial 203 mm (8 in) low frequency driver and a 25 mm (1 in) high frequency compression driver.

- 250 watt power handling
- 120° x 120° consistent broadband pattern control
- Overload protection

SCS 12

12" SPATIALLY CUED CINEMA SURROUND

The SCS 12 is a two-way, full range, high power cinema surround loudspeaker ideal for multi channel surround formats and is designed for overhead installation as well as for the standard on-wall installations. The SCS 12 is comprised of a high power coaxial 305 mm (12 in) low frequency driver and a 25 mm (1 in) high frequency compression driver.

- 400 watt power handling
- Extraordinary clarity surround with extended frequency response
- High power passive crossover network



8320

CINEMA SURROUND SYSTEMS

SURROUND SOLUTIONS FOR THE MODERN CINEMA

No other manufacturer provides a wider, more cost effective range of surround speaker solutions to meet the demands of modern cinema sound reproduction than JBL Professional.



8340A



8350

8320

COMPACT 8" CINEMA SURROUND

Features a 8" low frequency driver and a 1" soft dome driver combined with Internal Thermomaster technology allowing for 150 watts of power.

- Peak SPL of 122dB
- 100° x 90° coverage
- Special cabinet shape incorporates 20° angled front baffle

8340A

10" HIGH POWER CINEMA SURROUND

An unbeatable choice when very high power handling, high sensitivity, extended bass response and a remarkably compact cabinet are the requirements.

- Peak SPL of 126dB
- 100° x 80° coverage
- Special cabinet shape incorporates 20° angled front baffle



8350

10" VERY HIGH POWER CINEMA SURROUND

Offers very high power handling, high sensitivity, and extended bass response required for the extended dynamic range required by today's digital cinemas.

- Peak SPL of 130dB
- 100° x 80° coverage
- Special cabinet shape incorporates 20° angled front baffle



Mann Grauman's Chinese Theatre; Hollywood, California

SUBWOOFERS

HIGH PERFORMANCE 18" SUBWOOFERS FOR CINEMA



3635

The perfect choice for small cinemas with small budgets. Features one 18" transducer, an unobtrusive shallow enclosure, true JBL performance and a surprising price.

- 300 watt continuous power rating
- Single 2042H LF driver
- Shallow cabinet profile

4181

Cost effective 500 watt subwoofer system featuring an advanced technology 18" transducer mounted in a direct radiator, bass-reflex enclosure. It's ideal for use with digital soundtracks.

- 500 watt continuous power rating
- Usable response to 28 Hz
- Low power compression

4641

When a 600 watt cinema subwoofer is what you need, the 4641 is the perfect cost effective choice. The 4641 features one 18" JBL 2241 low frequency transducer.

- 600 watt continuous power rating
- Usable response to 25 Hz
- Approved by Lucasfilm, Ltd. for THX® installations

4642A

Dual 18" subwoofer system featuring two JBL 2241H low frequency transducers. This high-performance, cost effective system is ideal when smooth response at the lowest audible frequencies is required.

- 1200 watt continuous power rating
- Usable response to 22 Hz
- Approved by Lucasfilm, Ltd. for THX® installations

4645C

The industry standard and features a single JBL 2242 SVG low frequency transducer for the highest output with lowest distortion.

- 800 watt continuous power rating
- Usable response to 22 Hz
- Approved by Lucasfilm, Ltd. for THX® installations

5628

5628 Dual 18" ultra high power, lightweight, subwoofer featuring two JBL 2269H Ultra Long Excursion 18" Differential Drive® woofers.

- 4000 Watts Continuous power rating
- Usable response to 18Hz
- 16,000 W peak power handling



CONE TRANSDUCERS & COMPRESSION DRIVERS

HIGH QUALITY COMPONENTS FROM JBL

Manufacturing our own component transducers has historically set JBL apart from most other loudspeaker system manufacturers, and some of our numerous component transducers are available as sales models. All low-frequency units and compression drivers have been pre-qualified during the design phase with JBL's rigorous 100-hour 'torture test'. Units shown are legendary workhorses, often purchased in quantity for use in custom system designs.

2206H, 2226H/J, 2241H

VGC™ SERIES CONE TRANSDUCERS

Incorporate JBL's patented Vented Gap Cooling technology in an improved Symmetrical Field Geometry (SFG) magnet structure. JBL engineers optimized both magnet weight, flux density and field saturation resulting in reduction of overall driver weight and a significant reduction in harmonic distortion.

2242H

SVG™ SERIES CONE TRANSDUCERS

Incorporates JBL's patented Super Vented Gap™ technology for improvement in power handling capability while minimizing power compression.

2426H/J

25MM 1" EXIT COMPRESSION DRIVER

Incorporates JBL's titanium diamond diaphragm for ruggedness and outstanding frequency response.

2451H/J

38MM 1.5" EXIT COMPRESSION DRIVER

The 38 mm exit on the 2451H/J compression driver allows the Coherent Wave™ phasing plug to directly couple with Optimized Aperture™ Bi-Radial® horns for lower distortion and better coverage control. The large format 100 mm (4 in) diaphragm design includes JBL's exclusive three dimensional diamond pattern which increases the driver's output in the 5 kHz to 20 kHz range when combined with the Coherent Wave phasing plug.

2450H/J

49MM 2" EXIT COMPRESSION DRIVER

The 2450H/J uses the optimized configuration of the Coherent Wave phasing plug design, offering coherent summation of acoustical power up to much higher frequencies than previous designs. It also incorporates a neodymium rare-earth magnet assembly that provides the equivalent electromechanical conversion efficiency at two-thirds the size and one-third the weight required by previous large format compression driver designs.

HORNS & ACCESSORIES

HIGH QUALITY COMPONENTS FROM JBL

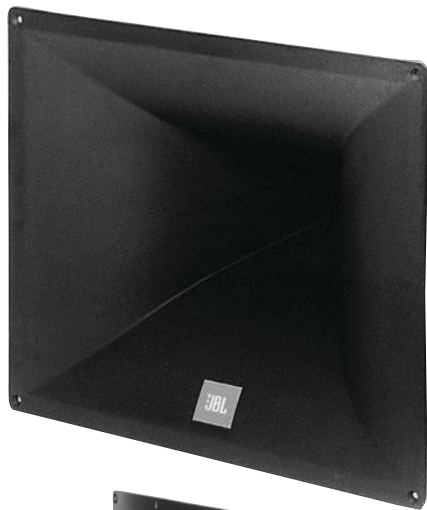

OPTIMIZED APERTURE™
MID-SIZE BI-RADIAL® HORN
MODEL 2352



2370A



2382A



2509A

2352

OPTIMIZED APERTURE™ MID-SIZE BI-RADIAL® HORN

The Optimized Aperture Mid-Size Bi-Radial Horns are designed to provide high sound pressure level at low distortion over the bandwidth of 630 Hz to beyond 18 kHz with very uniform horizontal and vertical coverage from an optimum size horn. Extensive modeling was used to optimize the coverage pattern, reducing both distortion and size.

2370A, 2380A, 2382A, 2385A

FLAT-FRONT BI-RADIAL® HORNS

The Flat-Front Bi-Radial Horns are designed for flush cabinet mounting or compact cluster applications. The horns provide uniform on and off axis frequency response at the rated frequencies.

The horn's small vertical mouth dimension (just slightly larger than the compression driver used to drive the horn) allows very compact single and multiple horn/driver systems to be put together. Should vertical pattern control be required below 2 kHz, two or more horns may be stacked vertically to restore full Bi-Radial™ performance.

2509A

HORN/DRIVER MOUNTING SYSTEM

The 2509 Professional Mounting Bracket is designed to facilitate easy installations and quick adjustability in a variety of applications. It is manufactured of rugged 1/8" steel and finished in black matte. The 2509 Professional Mounting Bracket is not intended for suspension applications.

The 2509A is a two piece system that allows aiming and rotation in three planes—vertical, horizontal and rotation around axis. The width of the mounting slots and an included adaptor gasket allow use with the 2350 Series and the 2380 Series.



18SWS1000

SURROUND
DETAILS

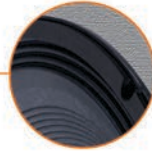

COOLING SYSTEM
DETAIL

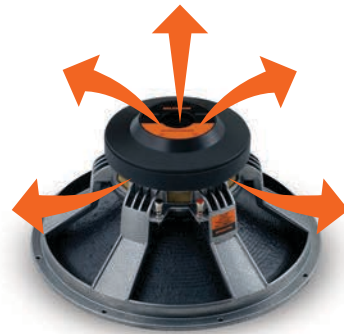

SUBWOOFER LINE

HIGH POWER SUBWOOFER

for professional use.

- Recommended for use as a subwoofer in a bass reflex or horn loaded cabinets.
- Capabilities: High power handling, Large linear excursion.
- Bandpass extension into the very low frequency zone.
- High power output with low distortion.
- Magnetic assembly was designed with Finite Element Analysis (FEA) for precise utilization and distribution of the magnetic field.
- Double poly-cotton spider for precise centering and increased linear displacement of the cone & coil.

COMPONENTS LINE

- 4" diameter spun laced fiberglass former withstands high temperatures and is mechanically strong.
- Cone is reinforced with non pressed synthetic fibers that greatly improve mechanical stability during large excursions.
- Fabric surround treated with rubberized materials for greater durability, better damping, and reduced standing waves.
- Exclusive MCS™ - Multi Cooling System for high SPL with less power compression.
- Die-cast Aluminum frame is durable and made to perform.
- High strength structural adhesives combined with materials that have good thermal resistance increase durability and reliability.

SUBWOOFERS LINE



SPECIFICATIONS

MODEL	15SWS800	15SWS1000	15SWS1100	15SWS1200	18SWS800	18SWS1000	18SWS1100	18SWS1200
Diameter	15"	15"	15"	15"	18"	18"	18"	18"
Impedance (Ω)	8	8	8	8	8	8	8	8
RMS (W)	800	1,000	1,100	1,200	800	1,000	1,100	1,200
Musical Program (W)	1,600	2,000	2,200	2,400	1,600	2,000	2,200	2,400
SPL 1W @ 1m (dB)	93	95	95	95	95	96	97	96
Frequency Resp. @ -10dB (Hz)	35 to 1,500	38 to 2,000	35 to 3,500	40 to 20,000	30 to 1,500	37 to 2,000	30 to 3,000	37 to 20,000
Resonance (Hz)	37	36	37	41	32	37	34	35
Voice Coil diameter in. (mm)	4 (100)							
Voice Coil	4 Layer Cu	4 Layer Al	Edge wound Al	4 Layer Al	4 Layer Cu	4 Layer Al	Edge wound Al	4 Layer Al
Magnet Weight oz. (g)	120 (3,400)			121.34 (3,400)	120 (3,400)	120 (3,400)	120 (3,400)	121.34 (3,440)
Basket	Die cast aluminum with epoxy finish							



MIDBASS LINE

MIDBASS EFFICIENT

- For midbass cabinets that require high power handling, efficiency, high fidelity, and low distortion.
- Extremely versatile these speakers can be used in two-way, three-way and line array systems.
- Magnet structure was designed with Finite Element Software (FEA) so that the magnetic field was optimized and evenly distributed. The 12" model has a copper shorted turn on the pole piece to lower distortion and extended the upper frequency response.
- Specially treated paper cone is reinforced with special fibers making it lighter, stronger and better sounding in the midbass.

COMPONENTS LINE

- Edge treated surrounds are either accordion or m-roll style to increase linearity during large excursions. Added advantages include the reduction of standing waves and improved acoustic coupling.
- Efficient venting cools the voice coil which reduces power compression, increases reliability and raises maximum SPL.
- Low profile die cast aluminum frame is easier to install in smaller, shallower and horn loaded enclosures.
- High temperature structural adhesives form a material bond with high shear strength greatly improving the durability and reliability of the product.

MIDBASS LINE



MODEL	SPECIFICATIONS		
	8MB4P	10MB3P	12MB3P
Diameter	8"	10"	12"
Impedance (Ω)	8	8	8
RMS (W)	250	300	500
Musical Program (W)	500	600	1,000
SPL 1W @ 1m (dB)	97	100	101
Frequency Resp. @ -10dB (Hz)	80 to 5,000	150 to 12,000	90 to 4,000
Resonance (Hz)	105	80	61
Voice Coil Diameter in.(mm)	1.8 (47)	3 (75)	2.4 (61)
Voice Coil	Kapton®/Aluminum		
Magnet weight oz.(g)	45 (1,280)	91 (2,570)	93 (2,640)
Frame Material	Die cast aluminum with epoxy finish		

Kapton® - Trademark, Du Pont



6W4P



8W4P

MIDBASS LINE

W4P

- Recommended for use in systems that require flat frequency response with extended range from the midbass to the upper midrange.
- An excellent choice when small unobtrusive speakers are called for in houses of worship, hotels, schools, clubs, restaurants and retail localizations.
- Durable copper voice coil on Kapton® is large enough to handle a lot of power but light enough for extended frequency response.
- Special resins are used to treat the long fiber paper cone increasing strength and improving sound quality.
- Cloth (8") and foam (6") half roll surrounds are treated to improve stability during high excursions, increase acoustic coupling and help dampen standing

COMPONENTS LINE

waves.

- Stamped steel epoxy coated frame is resistant to oxidation and won't bend even under harsh conditions.

MIDBASS LINE



MODEL	SPECIFICATIONS	
	6W4P	8W4P
Diameter	6"	8"
Impedance (Ω)	8	8
RMS (W)	100	150
Musical Program (W)	200	300
SPL 1W @ 1m (dB)	91	96
Frequency Resp. @ -10dB (Hz)	80 to 9,000	100 to 6,500
Resonance (Hz)	76	107
Voice Coil Diameter in.(mm)	1.3 (32)	1.8 (47)
Voice Coil	Kapton®/Copper	
Magnet weight oz.(g)	20 (560)	44 (1,240)
Frame Material	Stamped steel epoxy finish	

Kapton® - Trademark Du Pont



125W600



155W600



185W600

WOOFER LINE

WS

- Recommended for smaller low frequency cabinets where high power handling, seamless linearity and low distortion sound is required.
- Ideal for touring and fixed installations. Recommended for use in sidefill and stage monitor speakers.
- Magnet assembly design optimized by finite element software (FEA) to improve the control of the flux in the gap.
- Double spiders control the alignment of the cone during high excursions.
- 4" diameter Copper voice coil on a high temperature Kapton® former for increased power handling and structural durability.

COMPONENTS LINE

- Composite cellulose cone that is reinforced with long synthetic fibers improves mechanical stiffness, damping, and reduces standing waves.
- Efficient vented cooling system reduces power compression and improves efficiency.
- High temperature structural adhesives permanently bonds components increasing durability and reliability.

MIDBASS LINE



MODEL	SPECIFICATIONS			
	12WS600	15WS600	18WS600	15WS700
Diameter	12"	15"	18"	15"
Impedance (Ω)	8	8	8	8
RMS (W)	600	600	600	700
Musical Program (W)	1,200	1,200	1,200	1,400
SPL 1W @ 1m (dB)	95	97	98	98
Frequency Resp. @ -10dB (Hz)	45 to 3,000	40 to 3,500	35 to 3,000	50 to 4,5000
Resonance (Hz)	46	35	33	37
Voice Coil Diameter in. (mm)	4 (100)			
Magnet Weight oz.(g)	94 (2,700)	94 (2,700)	94 (2,700)	121.34 (3440)
Frame Material	Die cast aluminum with epoxy finish			

Kapton® - Trademark Du Point



10CV5



12CV5



15CV5

WOOFER LINE

CV5

- Professional woofer, recommended for mid and low frequencies reinforcement and designed to meet the most diverse needs, ideal for mobile units or in environments such as auditoriums, ballrooms and nightclubs.
- The high efficiency in sound reproduction is due to the excellent combination of its components.
- The paper cone reinforced with long fibers, provides the array great stability, high yield and low distortion.
- The voice coil is made of a very resistant to high Temperatures wire and winding in Kapton former[®].

COMPONENTS LINE

- Frame in reinforced steel and epoxy paint gives the set high strength and mechanical structure.
- The aluminum cap ensures a perfect heat dissipation that comes from the voice coil.
- The use of high strong adhesive guarantees an optimal cohesion and durability to the components.

WOOFER LINE



MODEL	SPECIFICATIONS		
	10CV5	12CV5	15CV5
Diameter	10"	12"	15"
Power (W)	100 W	150 W	150 W
Musical Program (W)	250 W	350 W	400 W
SPL (dB)	91 dB 1W @ 1m (dB)	97 dB 1W @ 1m (dB)	99 dB 1W @ 1m (dB)
Frequency Resp	65Hz ~ 5500 KHz	70Hz ~ 5000 KHz	70Hz ~ 4000 KHz
Resonance (Hz)	80 Hz	70 Hz	70 Hz
Voice Coil diameter	32 mm	46 mm	46 mm
Magnet Weight (g)	440 g	560 g	920 g
Impedance	8 Ω		
Die cast	Aluminum with epoxy finish		



8PW7



15PW6



15PW7

WOOFER LINE

PW

- Recommended for use in small and medium-size venues where high performance reproduction of the critical midrange frequencies and low frequencies are desired.
- The right choice for two way loudspeakers that are used for sound reinforcement in auditoriums, ballrooms, nightclubs, and live music stages.
- Precision wound copper voice coil is bonded to a Kapton® former and coated so that it holds it's structural shape under high power conditions.
- Paper cone reinforced with long fibers is specially treated to ensure faithful reproduction and tone in the voice band.
- Accordion edge fabric surround is specially treated to reduce fatigue and lower

COMPONENTS LINE

- distortion.
- Aluminum dust cap dissipates heat from the voice coil improving power handling and reducing power compression. No aluminum dust cap on (8PW7, 10PW7, 12PW7, and 15PW7).
- Mechanically strong and weather resistant epoxy coated stamped steel frame.

WOOFER LINE



MODEL	SPECIFICATIONS				
	8PW7	10PW7	12PW7	15PW7	15PW6
Diameter	8"	10"	12"	15"	15"
Impedance (Ω)	8	8	8	8	8
RMS (W)	140	150	250	300	400
Musical Program (W)	300	300	500	600	800
SPL 1W @ 1m (dB)	93	95	95	97	97
Frequency Resp. @ -10dB (Hz)	70 to 8,000	60 to 4,000	40 to 4,500	40 to 4,500	60 to 4,000
Resonance (Hz)	79	67	42	43	37
Voice coil Diameter in.(mm)	1.3 (32)	1.8 (46)	2.4 (60)	2.4 (60)	3 (75)
Magnet Weight oz. (g)	20 (560)	32 (920)	46 (1300)	46 (1300)	86 (2440)
Frame Material	Stamped steel with epoxy finish				



COMPRESSION DRIVER LINE

COMPRESSION DRIVER

PHENOLIC

- Recommended for midrange applications in multi-way PA's, stage monitors, side fills and high SPL car audio systems.
- High sensitivity, low distortion and smooth response.
- Precisely formed phenolic diaphragm produces high fidelity sound through out the midrange.
- Diaphragm voice coil is bonded to Kapton™ with high temperature adhesives to increase durability and raise power handling.
- "Phase Plug" is an acoustic transformer with optimized geometry to reduce phase cancellations.

COMPONENTS LINE

- Magnetic Fluid in the gap (models D305 and D405) helps center the coil, improves heat dissipation, and reduces distortion.
- Quick change drop in diaphragm for easy repair.



MODEL	SPECIFICATIONS			
	D200	D250-X	D305	D405
Throat diameter	1"		2"	
impedance (Ω)	8			
RMS (W)	50 ⁽¹⁾	100 ⁽²⁾	75 ⁽²⁾	100 ⁽²⁾
Musical Program (W)	100	200	150	200
SPL 1W @ 1m (dB)	107	107	110	110
Frequency Resp. @ -10dB (Hz)	500 to 7,000	400 to 9,000	400 to 9,000	300 to 7,000
Rec. a 12 dB/8° (Hz)	500	500	500	
Voice coil diameter in(mm)	51	51	75	100
Magnet weight oz.(g)	290	332	1,600	2,640
Housing material	Plastic	Aluminum	Plastic	
Horn connection	Screw on		Bolt on	

(1) Xover 1,200Hz 12dB/oct (2) Xover 2,000Hz 12dB/oct



COMPRESSION DRIVER TITANIUM

- Recommended for use in high performance compact, two-way, multi-way and line array systems.
- For use in sound reinforcement, side fill and stage monitor loudspeakers.
- World class drivers with excellent performance.
- High sensitivity and linear frequency response.
- Pure TITANIUM Diaphragm is accurately shaped to produce high frequencies with clarity.
- Innovative IPF® - Impregnated Polymer Fiber (model D3305Ti) diaphragm surround reduces ringing and makes the high frequencies more linear.

COMPONENTS LINE

- DPD® - Driver Protection Device protection circuit (model D3305Ti), protects the compression driver by reducing the input power during clipping and overload conditions.
- Precisely designed "Phase Plug" is an acoustic transformer that helps prevent phase cancellations.
- Copper shorting ring on the pole piece reduces the modulation of the magnetic field, lowers distortion and increases high frequency output.
- Magnetic Fluid in the gap (model D3305Ti) lowers distortion, helps to center the voice coil and wicks away heat.
- Repair of the driver is easy because the quick change diaphragm indexes to center and has a unique gold-plated contact system (model D3305Ti).

COMPRESSION DRIVER LINE



MODEL	SPECIFICATIONS						
	D202Ti	D220Ti	D220Ti OMF	D3305Ti DPD	D409Ti	D405Ti	D4400Ti
Throat diameter	1"			2"			
Impedance (Ω)	8						
RMS (W)	60 ¹	80 ¹		75 ²	150	125 ³	125 ³
Musical Program (W)	120	160		150	300	250 ³	250 ³
SPL 1W @ 1m (dB)	106	109		108	111	109	112
Frequency Resp. @ -10dB (Hz)	1,000 to 20,000	1,000 to 21,000		500 to 20,000	400 to 20,000	400 to 18,000	400 to 20,000
Rec. X-over, 12dB/oct min. (Hz)	1,500			800		800	800
Voice coil diameter in (mm)	1.7 (44)			3(75)	4 (100)	4 (100)	4 (100)
Voice coil	Kapton®/CCAW			Kapton®/CCAW edgewound	CCAW	Kapton®/CCAW	
Magnet Weight oz.(g)	8 (210)	24 (675)		57(1,600)	93 (2,640)	93 (2,640)	121.34 (3,440)
Housing material	Plastic				Aluminum	Plastic	Aluminum
Horn connection	Screw on			Bolt on		Screw on	

Kapton® - Trademark Du Pont

(1) Xover 1.200Hz 12dB/oct (2) Xover 2.000Hz 12dB/oct



HORN LINE

HORN LINE

LONG THROW

- Ideal for sound reproduction in small, medium and large-size environments.
- Several models available with different sound dispersion designed to fit almost any application.
- Optimized to increase directivity which raises max SPL, and to improve loading of the driver which magnifies efficiency.
- Designed to couple with Selenium drivers to produce high clarity sounds.



MODEL	SPECIFICATIONS		
	HL 14-25	HL 14-50N	HL 4750-SLF
Throat	1"	2"	2"
Material	Plastic	Aluminum	Fiberglass
Sound Dispersion HxV	45° x 45°	45° x 45°	40° x 20°
Low Frequency Limit. (Hz)	600	600	400
Driver Connection	Screw on	Bolt on	Bolt on
Width in. (mm)	6.1 (156)	6.1 (176)	17.5 (445)
Height in. (mm)	6.1 (156)	6.1 (165)	11 (280)
Length in (mm)	10.1 (258)	5.1 (134)	13.8 (352)



HORN LINE

MEDIUM AND SHORT THROW

- Ideal for sound reproduction in small, medium and large-size environments.
- Several models available with different sound dispersion designed to fit almost any application.
- Optimized to increase directivity which raises max SPL, and to improve loading of the driver which magnifies efficiency.
- Designed to couple with Selenium drivers to produce high clarity sounds.

HORN LINE



	SPECIFICATIONS					
MODEL	HM11-25	HM17-25	HM25-25	HM3950-SLF	HM4750-SLF	HC2325
Throat	1"	1"	1"	2"	2"	1"
Material	Plastic	Plastic	Aluminum	Fiberglass		Plastic
Sound Dispersion HxV	60° x 60°	60° x 40°	90° x 60°	60° x 30°	90° x 40°	100° x 40°
Low Frequency Limit (Hz)	1,200	1,500	1,200	400	400	600
Driver Connection	Screw on	Screw on	Screw on	Bolt on	Bolt on	Screw on
Width in (mm)	4.5 (115)	6.3 (160)	10.8 (274)	15.3 (390)	17.5 (445)	10 (254)
Height in (mm)	4.5 (115)	5.7 (145)	6.5 (164)	8.1 (206)	11.4 (290)	5 (128)
Length in (mm)	3 (75)	4.1 (103)	5.9 (151)	9.2 (234)	8.3 (210)	5.7 (145)



ST350



ST400BLK



ST304

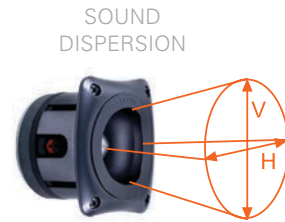

SUPER TWEETER LINE

ST

- Ideal super tweeter when the reproduction of high frequencies must define the instruments.
- Recommended for PA systems, stage monitors and most sound reinforcement systems in general.
- Extremely high sensitivity and lower distortion.
- The geometry of the magnetic circuit was optimized with Finite Element Analysis (FEA) in order to efficiently utilize and distribute the magnetic field in the gap.

COMPONENTS LINE

- The Phenolic diaphragms ability to hold it's shape is key to the production of high fidelity, high frequency sound.
- Durability of the super tweeter is increased by using a high temperature voice coil that's bonded to a Kapton® former.
- Components are bonded with high temperature structural adhesives to increase durability and improve reliability.
- Easy diaphragm replacement for faster repairs.

SUPERTWEETER LINE



MODEL	SPECIFICATIONS				
	ST200	ST304	ST350	ST400 BLK	ST302-X
Impedance (Ω)	8	8	8	8	8
RMS (W)	70 ⁽¹⁾	40 ⁽²⁾	100 ⁽²⁾	150 ⁽²⁾	125 ⁽²⁾
Musical Program (W)	140	80	100 ⁽²⁾	150 ⁽²⁾	250
SPL 1W @ 1m (dB)	105	106	111	111	106
Frequency Resp. @ -10dB (Hz)	2,000 to 20,000	3,500 to 18,000	2,500 to 20,000	3,000 to 20,000	3,500 to 20,000
Voice Coil Diameter	1.8 (46)		1.7 (42)		1.8 (46)
Sound Dispersion HxV	40° x 40°		120° x 40°	40° x 40°	
Magnet weight	8 (220)	11 (320)	17 (470)	15 (430)	440
Diaphragm	Phenolic				
Housing material	Plastic				

Product Index

PRODUCT	PAGE	PRODUCT	PAGE	PRODUCT	PAGE
2206H	296	AM7315/95 & /64	257	CONTROL 28 & 28T-60	270
2226H/J	296	ASB4128	259	CONTROL 29AV-1	271
2241H	296	ASB6112	260	CONTROL 2P	288
2242H	296	ASB6115	260	CONTROL 30	271
2352	297	ASB6118	259	CONTROL 312CS	273
2370A	297	ASB6125	260	CONTROL 321C & 321CT	273
2380A	297	ASB6128	259	CONTROL 322C & 322CT	273
2382A	297	ASB6128V	259	CONTROL 328C & 328CT	273
2385A	297	ASB7118	260	CONTROL 40CS/T	275
2426H/J	296	ASB7128	260	CONTROL 42C	275
2450H/J	296	ASH6118	259	CONTROL 45C/T	275
2451H/J	296	AW266 & AW266-LS	264	CONTROL 47C/T	275
2509A	297	AW295 & AW295-LS	264	CONTROL 47HC	275
3252N	292	AW526 & AW526-LS	264	CONTROL 47LP	275
3635	295	AW566 & AW566-LS	264	CONTROL 5	288
3677	292	AW595 & AW595-LS	264	CONTROL 50PACK	269
3678	292	AWC129	265	CONTROL 50S/T	269
3722 & 3722N	290	AWC159	265	CONTROL 52	269
3730	291	AWC15LF	265	CONTROL 60PS/T	268
3731 & 3731T	291	AWC82	265	CONTROL 62P	268
3732 & 3732T	291	CBT 100LA-1	266	CONTROL 65P/T	268
4181	295	CBT 100LA-LS	266	CONTROL 67HC/T	268
4641	295	CBT 200LA-1	267	CONTROL 67P/T	268
4642A	295	CBT 50LA-1	266	CONTROL CRV	270
4645C	295	CBT 50LA-LS	266	CONTROL SB2	271
4722 & 4722N	290	CBT 70J-1	266	CONTROL SB210	271
4732 & 4732T	291	CBT 70J-1 + CBT70JE-1	267	CSS-1S/T	279
5628	295	CBT 70JE-1	266	CSS-H15	279
5674	292	CONTROL 1 PRO	288	CSS-H30	279
5732	289	CONTROL 126W/WT	272	CSS8004	279
5742	289	CONTROL 128W/WT	272	CSS8008	279
8124	278	CONTROL 12C/T	277	CSS8018	279
8128	278	CONTROL 14C/T	277	EON206P	228
8138	278	CONTROL 16C/T	277	EON610	227
8320	294	CONTROL 19CS & 19CST	276	EON612	227
8340A	294	CONTROL 226C/T	274	EON615	227
8350	294	CONTROL 227C & 227CT	274	INTELLIVOX DC & DS	281
9320	293	CONTROL 23 & 23T	270	INTELLIVOX DSX	281
AC2212/95, /64 & /00	258	CONTROL 24C MICRO	276	JRX212	232
AC2215/95, /64 & /00	258	24CT MICRO	276	JRX215	232
AL7115	258	24CT MICROPLUS	276	JRX218S	232
AM5212/64-66-95-00-26	258	CONTROL 24C, 24CT & 24CT-BK	276	JRX225	232
AM5215/64-66-95-26	258	CONTROL 25 & 25T	270	LSR305	287
AM7200/95 & /64	257	CONTROL 25AV & 25AV-LS	270	LSR308	287
AM7212/64-66-95-00-26	257	CONTROL 26-DT	276	LSR310S	287
AM7215/64-66-95-26	257	CONTROL 26C, 26CT & 26CT-LS	276	LSR4328P	286

Product Index

JBL PROFESSIONAL PRODUCT INDEX

PRODUCT	PAGE	PRODUCT	PAGE	PRODUCT	PAGE
LSR6312SP	285	PRX718XLF	231	VRX918S.	237
LSR6325P-1	285	PRX725	230	VRX918SP.	237
LSR6328P	285	PRX735	231	VRX928LA	237
LSR6332	285	SCS 12.	293	VRX932LA-1	237
LSR705I	284	SCS 8	293	VRX932LAP	237
LSR708I	284	STX812M	235	VT4880	243
MD1	251	STX815M	235	VT4880A.	243
MD2	251	STX818S.	235	VT4880ADP-DA	247
MD3	251	STX825	235	VT4881A.	243
MD46	252	STX828S.	235	VT4881ADP-DA	247
MD49	252	STX835	235	VT4882	243
MD52	252	VLA301	253	VT4882DP-DA	247
MD55	252	VLA301H	253	VT4883	243
MD7	251	VLA601	253	VT4886	242
PD5122	255	VLA601H	253	VT4887A.	242
PD5125	255	VLA901	253	VT4887ADP-DA	247
PD6200	255	VLA901H	253	VT4888	242
PD6212	255	VP7210/95DP	249	VT4888DP-DA	247
PD6322	255	VP7212/64DP (60° X 40°)	249	VT4889-1	242
PD743	254	VP7212/95DP (90° X 50°)	249	VT4889ADP-DA	247
PD764	254	VP7212/95DPC	249	VTX F12	240
PRX412M	233	VP7212MDP.	249	VTX F15	240
PRX415M	233	VP7215/64DP (60° X 40°)	249	VTX F18S	240
PRX418S.	233	VP7215/95DP (90° X 50°)	249	VTX G28	239
PRX425	233	VP7215/95DPC	249	VTX S25	239
PRX710	230	VP7315/64DP	249	VTX S28	239
PRX712	230	VPSB7118DP	249	VTX V20	239
PRX715	230	VRX915M	237	VTX V25	239
PRX715XLF	231	VRX915S.	237		

JBL AUDIO ENGINEERING FOR SOUND REINFORCEMENT

by John Eargle and Chris Foreman



This book comprehensively covers all aspects of speech and music sound reinforcement. It is divided into four sections: Section 1 provides the tutorial fundamentals that all audio engineers will need, discussing subjects such as fundamentals of acoustics, psychoacoustics, basic electrical theory and digital processing. Section 2 deals with the fundamental classes of hardware that the modern engineer will use, such as loudspeaker systems and components, microphones, mixers, amplifiers and signal processors. Special attention is given to digital techniques for system control and to audio signal analysis. Section 3 deals with the basics of system design, from concept to final realization. It covers topics such as basic system type and speech intelligibility, site survey, user needs analysis and project management. Section 4 discusses individual design areas, such as sports facilities, large-scale tour sound systems, high-level music playback, systems for the theater, religious facilities, and other meeting spaces. The book is written in an accessible style, but does not lack for ample amounts of technical information. JBL and HPro brand products are prominently featured as examples to illustrate the principles and applications. Available at bookstores and on line.



Celebrating sixty years of success in the speaker industry, this book offers details on the people and products that have made JBL famous. It features full-color photos, historical advertisements, and hundreds of diagrams and images, many taken right from JBL's archives. Topics include stories behind the development of innovative applications for consumer products, as well as systems installations for stadiums, tour sound, movie theaters, recording studios, and places of worship. In addition to the technical info that explains the innovation, this book covers the brilliant engineers, and colorful record producers, musicians and technicians who had the vision to pursue a "better way." Available at bookstores and on line.

JBL LIMITED WARRANTY

The JBL Warranty on professional loudspeaker products (except for enclosures) remains in effect for five years from the date of the first consumer purchase. JBL amplifiers are warranted for three years from the date of the original purchase. Enclosures and all other JBL products are warranted for two years from the date of the original purchase.

Your JBL Warranty protects the original owner and all subsequent owners as long as: A.)Your JBL product has been purchased in the Continental United States, Hawaii or Alaska. (This Warranty does not apply to JBL products purchased elsewhere except for purchases by military outlets. Other purchasers should contact the local JBL distributor for warranty information.) and B.)The original dated bill of sale is presented whenever warranty service is required.

Except as specified below, your JBL Warranty covers all defects in material and workmanship. The following are not covered: Damage caused by accident, misuse, abuse, product modification or neglect; damage occurring during shipment; damage resulting from failure to follow instructions contained in your Instruction Manual; damage resulting from the performance of repairs by someone not authorized by JBL; claims based upon any misrepresentations by the seller; any JBL product on which the serial number has been defaced, modified or removed. JBL will pay all labor and material expenses for all repairs covered by this warranty.

JBL continually engages in research related to product improvement. New materials, production methods and design refinements are introduced into existing products without notice as a routine expression of that philosophy. For this reason, any current JBL product may differ in some respect from its published description but will always equal or exceed the original design specifications unless otherwise stated.

Telephone (818) 894-8850
Domestic Sales Fax (818) 830-7801
International Sales Fax (818) 830-7802
Customer Service Fax (818) 830-7881



JBL Professional
8500 Balboa Boulevard
Northridge, CA 91329 USA
Visit us online at www.jblpro.com