

Key Features:

- ▶ Advanced Linear Spatial Reference design ensures flatter-off-axis response for greater clarity at the mix position.
- ▶ RMC™ Room Mode Correction provides electronic control of room modes. User measurement and calibration kit available.
- ▶ Differential Drive® technology with dynamic braking for extended low frequency response and minimal power compression.
- ▶ Integrated bi-amplification with factory calibrated sensitivities.
- ▶ Titanium composite high frequency transducer with elliptical oblate spheroidal waveguide for precise pattern control.
- ▶ Magnetically shielded high frequency transducer minimizes interference when used in close proximity to video monitors.
- ▶ High-Density baffle for high inertial ground and low resonance.
- ▶ Linear Dynamics Aperture port design eliminates port turbulence and reduces port compression.
- ▶ Reinforced enclosure and convenient mounting points for mounted installation.
- ▶ Integral handles facilitate ease of positioning.

The LSR6328P studio monitor is designed for use in critical stereo and multi-channel monitoring applications that require exceptional spectral accuracy and high SPL capability. The LSR6328P combines the latest in JBL's renowned transducer and system technology with psychoacoustically derived spatial response criteria, resulting in a more accurate studio monitoring reference system. In this design process, the system's frequency response over the forward listening range ($\pm 15^\circ$ vertically and $\pm 30^\circ$ horizontally) is optimized, as opposed to the conventional approach of optimizing the response directly on-axis. This design approach involved careful component design, selection of crossover frequency, and precise baffle geometry and detail. The result is a system that can be used for the most critical judgements of recording balance, image placement, and equalization. The matching of the LSR6328P system to the listening environment is further enhanced through the use of RMC, an analysis/correction system that identifies and corrects response to compensate for the dominant low frequency standing wave in the system's room response. In addition to a rich array of performance features, the LSR6328P has a reinforced enclosure and integral



mounting points to facilitate wall mounting. Recessed handles facilitate easy positioning of the loudspeaker in the environment and aid in transportability.

218F Low Frequency Transducer

The 8" woofer is based on JBL's patented Differential Drive® technology. With dual 1.5" voice coils, power compression is kept at a minimum to reduce spectral shift as output power levels increase. An added third coil located between the drive coils acts as a dynamic brake to limit excess excursion and reduces audible distortion at maximum levels. The cone is made of a carbon fiber composite forming a rigid piston and is supported by a soft butyl rubber surround.

053TiS High Frequency Transducer

The high frequency transducer has a 1" composite diaphragm integrated with an Elliptical Oblate Spheroidal (EOS) Waveguide with wide uniform dispersion that is critical to the smooth spatial response required in today's working environments. The driver is shielded to minimize the interference when used in close proximity to video monitors.

Bi-amplified Power System

The LSR6328P combines two high power amplifiers with an active dividing network. Included are over 250 watts of continuous low frequency power and 120 watts for the high frequency section. The active dividing network produces a 36/dB-per-octave Linkwitz-Riley type response for smooth transition between transducers, both in the frequency and time domains. This results in exceptional imaging and a lack of time smear, and the circuitry also yields a tonal-artifact-free noise floor.

Input Sensitivity and Equalization:

User adjustments include level calibration settings for use with professional and semiprofessional equipment, as well as fine tuning with variable level trim. Neutrik "Combi" input receptacles accommodate both XLR and $\frac{1}{4}$ " connectors, either balanced or unbalanced. DIP switch 1 inserts a variable input trim for up to 13 dB of input attenuation. DIP switches 2 & 3 allow selection of either -10 dBV, +4, or +8 dBu calibrated input sensitivities on the $\frac{1}{4}$ " or XLR inputs. A Very Low Frequency (VLF) high-pass filter provides protection from excess woofer excursion at maximum playback levels. DIP Switch 4 disables this filter providing slightly extended deep bass response below the enclosure port tuning and allowing the user to observe cone motion caused by sub-sonic signal.

Boundary compensation is user-selectable to correct low frequency and mid-bass build-up when the speakers are placed close to a corner or wall. Three settings (-1.5 dB, -3 dB, -4.5 dB) are provided using DIP switches 5 & 6. DIP switches 7 & 8 provide 1.5 dB high-frequency boost and attenuation to allow compensation for dull or bright listening environments.

► LSR6328P Linear Spatial Reference Bi-amplified Studio Monitor

RMC™ Equalization

Through the use of a test CD, sound level meter and Q template, the user can identify any dominant room mode over the tuning range from 26 to 96 Hz that effects the LF response at the listening position. The inverse curve can then be entered into the system's electronics – to exactly compensate the offending peak. Using the RMC Calibration Kit*, the user is also instructed specifically what to look for, and potentially poor room locations can be avoided. RMC kit contains all items required to carry out the RMC system calibration process. *(Purchased separately. Kit is included with each LSR6312SP Subwoofer)

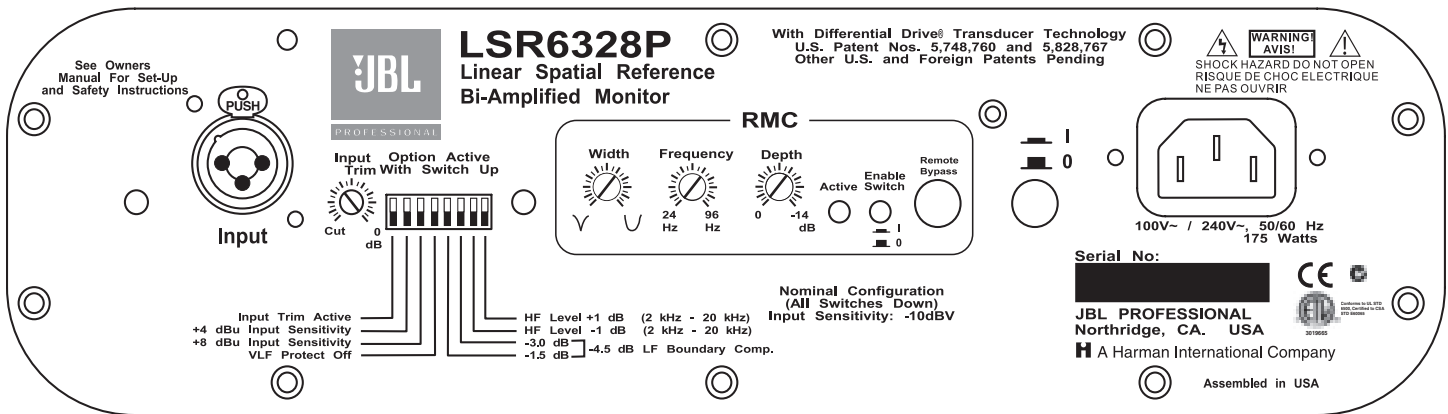

Linear Spatial Reference Design and Measurement Techniques

We all know that many loudspeakers have similar measurements but sound different. By going beyond simple on-axis frequency response measurements, JBL defines the ultimate performance specification for new systems – what it will sound like in your room.

While other manufacturers use a single on-axis frequency response measurement taken at one point in space, JBL measures monitor systems over a sphere that encompasses all power radiated into the listening room – in every direction. This data reflects 1296 times the information of a single on-axis response curve. Seventy-two measure-

ments of the direct sound field, the reflected sound field, and the reverberant field, the entire sound field heard by the listener, is correlated to optimize response at the listening position. In place of spectral smoothing used by some manufacturers, which actually conceals data, the JBL approach actually exposes flaws in systems, such as resonances, poor dispersion and other causes of off-axis coloration.

The data shown below is a set of spatially measured graphs that are the heart of JBL's philosophy.

LSR6328P Response Curves

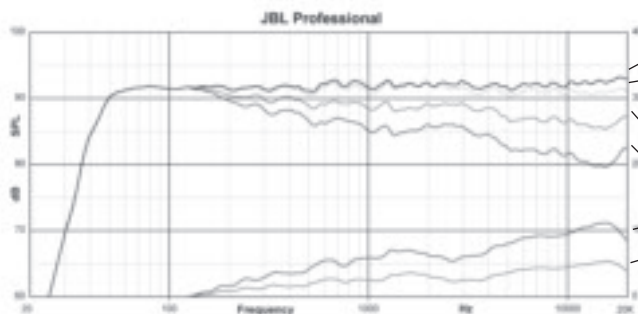

1. On-Axis Response
2. Spatially Averaged Response over a range of +/- 30° Horizontal & +/- 15° Vertical
3. First Reflection Sound Power
4. Total Radiated Sound Power
5. DI of On-Axis Response
6. DI of First Reflections

Specifications:

System:	
Frequency Response (+1, -1.5 dB):	50 Hz - 20 kHz
Enclosure Resonance Frequency:	38 Hz
Low Frequency Extension:	User controls set to default
-3 dB:	46 Hz
-10 dB:	36 Hz
Low-High Frequency Crossover:	1.7 kHz 6th-order acoustic Linkwitz-Riley
Distortion, 96 dB SPL, 1 m:	
Mid-High Frequency (120 Hz - 20 kHz):	
2nd Harmonic:	<0.6%
3rd Harmonic:	<0.5%
Low Frequency (<120 Hz):	
2nd Harmonic:	<2%
3rd Harmonic:	<1%
Maximum SPL (80 Hz - 20 kHz):	>108 dB SPL / 1m
Maximum Peak SPL (80 Hz - 20 kHz):	>111 dB SPL / 1m
Signal Input:	Neutrik "Combi" XLR-¼-in tip-ring-sleeve balanced or unbalanced positive voltage applied to XLR pin 2 (¼" tip) produces outward woofer motion
Calibrated Input Sensitivity, XLR & ¼":	
+4 dBu / +8 dBu:	96 dB SPL / 1 m
-10 dBV:	96 dB SPL / 1 m
AC Input Voltage:	100 /240 VAC, 50/60 Hz (auto sensing)
AC Input Connector:	IEC
Long-Term Maximum System Power:	220 watts (IEC265-8)
Self-Generated Noise Level:	<10 dBA / 1 m Tonal-artifact-free noise floor
User Controls:	
High Frequency Control (2 kHz - 20 kHz):	+1 dB, 0 dB, -1 dB
Low Frequency Control (< 100 Hz):	0 dB, -2 dB
Low Frequency Alignments:	36 dB/octave, 24 dB/octave (VLF protection off)
Calibrated Input Sensitivity:	-10 dBV, +4 dBu, +8 dBu
Boundary Compensation Settings:	0, -1.5, -3.0, -4.5 dB
Variable Input Attenuation:	0 dB to -13 dB
RMC External Bypass:	¼" jack
RMC Active Switch:	In/Out
RMC Frequency Adjust:	26 Hz - 96 Hz (10th octave, 18 centers)
RMC Depth Adjust:	0 - 14 dB (cut only)
RMC Q Adjust:	1/20th to 1/2 octave, 21 steps
Transducers:	
Low Frequency Model:	218F
Diameter:	203 mm (8 in)
Voice Coil:	38 mm (1.5 in) Differential Drive® with dynamic braking coil
Magnet Type:	Ferrite, with integral heat sink
Cone Type:	Carbon fiber composite
Impedance:	2 ohms
High Frequency Model:	053TIS
Diameter:	25 mm (1 in) diaphragm
Voice Coil:	25 mm (1 in)
Magnet Type:	Ferrite, shielded
Diaphragm Type:	Damped titanium composite
Other Features:	Elliptical oblate spheroidal waveguide
Impedance:	4 ohms
Amplifier:	
Low Frequency:	
Topology:	Class A-B, all discrete
Sine Wave Power Rating:	250 watts (<0.1% THD into rated impedance)
THD + N, ½ Power:	<0.05%
High Frequency:	
Topology:	Class A-B, monolithic
Sine Wave Power Rating:	120 watts (<0.1% THD into rated impedance)
THD + N, ½ Power:	<0.05%
Physical:	
Finish:	Smooth dark graphite
Handles:	2 each, flush mounted on sides
Mounting:	4 threaded mounting points conforming to industry standard square pattern, 127 x 70 mm (5 x 2.75 in) center to center. M6 metric threads.
Enclosure Volume (net):	28 liter (1 cu ft)
Low Frequency Vent:	Rear ported linear dynamics aperture (integrated with amplifier heat sink)
Baffle Construction:	Injection-molded structural ABS
Enclosure Construction:	19 mm (¾ in) MDF
Net Weight:	17.7 kg (39 lb)
Dimensions (HxWxD):	406 x 330 x 325 mm (16 x 13 x 12.8 in)

Caution: Unsafe mounting or overhead suspension of any heavy load can result in serious injury and equipment damage. Mounting of speakers should be done by qualified persons in accordance with all applicable local safety and construction standards. Be certain to follow the instructions provided by the manufacturer of the mounting bracket. Before selecting a mounting bracket, be certain that it is capable of supporting the weight of the speaker to be mounted.

Amplitude & Phase

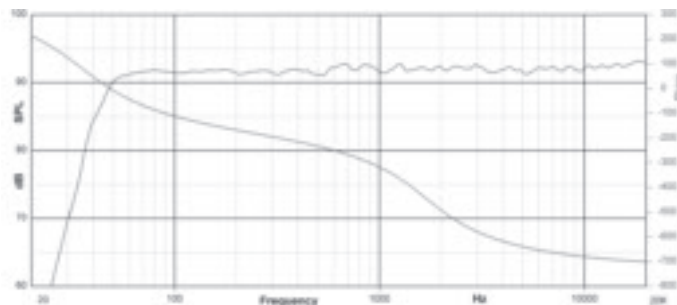

96 dB/1 m (Distortion raised 20 dB)

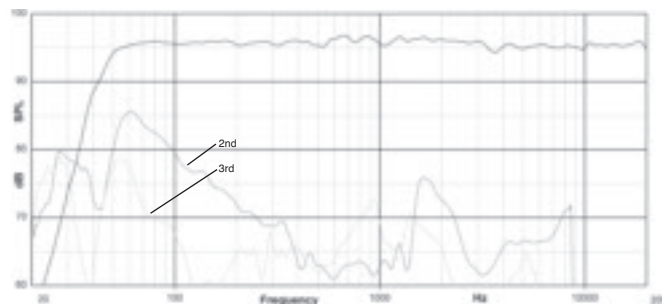

102 dB/1 m (Distortion raised 20 dB)

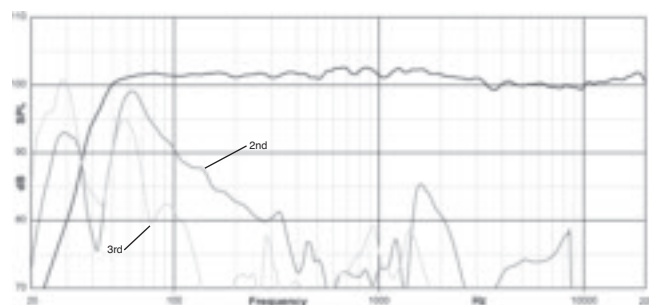

Notes:

All measurements unless otherwise stated made anechoically in a 4π environment at 2 meters, referenced to 1 meter by inverse square law.

The reference measurement microphone position is located perpendicular to the centerline of the low and high frequency transducers at the point 55 mm (2.2 in) below the center of the high frequency diaphragm.

Acoustic loading provided by the listening room increases maximum SPL capability and low frequency bass extension as compared to stated anechoic values.

Distortion measurements performed with the input voltage necessary to produce the stated A-weighted SPL at the stated measurement distance. Distortion figures refer to the maximum distortion measured in any 1/10th octave wide band in the stated frequency range.

JBL continually engages in research related to performance improvements. New materials, production methods, and design refinements are introduced into existing products without notice as a routine expression of that philosophy. For this reason, any current JBL product may differ in some respect from its published description, but will always equal or exceed the original design specification unless otherwise stated.

► LSR6328P Linear Spatial Reference Bi-amplified Studio Monitor

Acoustic Contribution

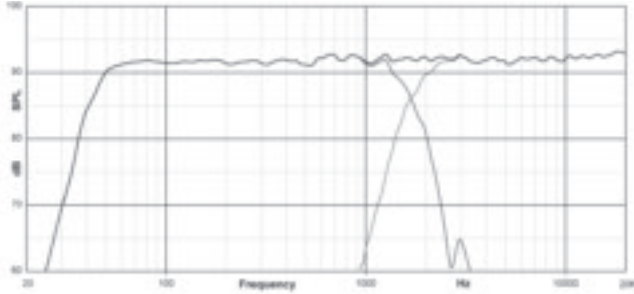

Impulse Response

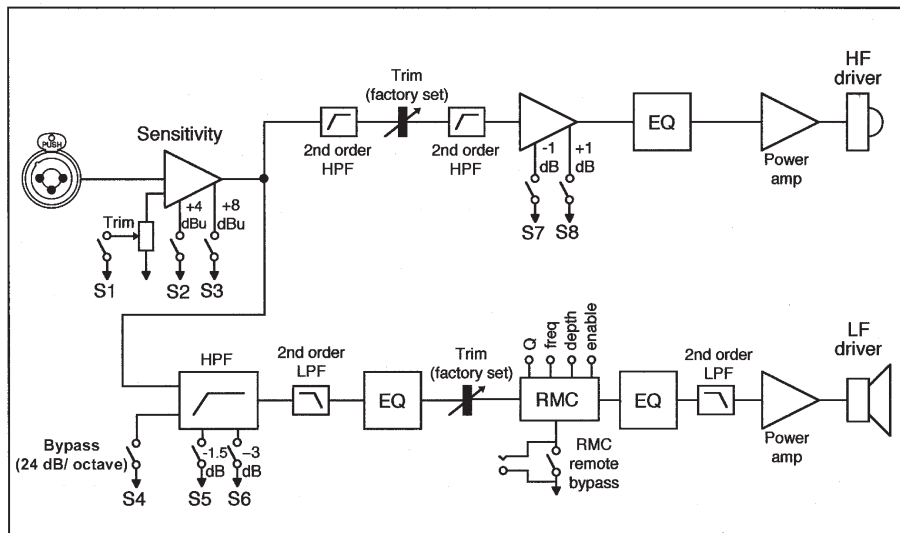
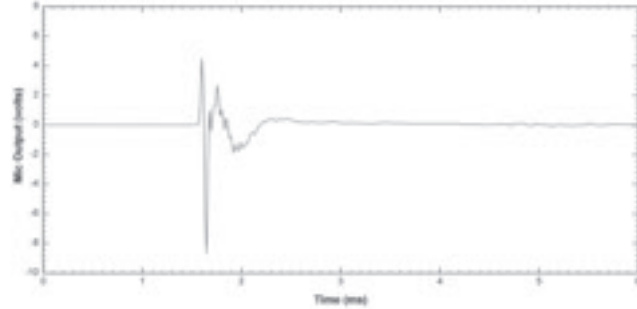

JBL Professional
 8500 Balboa Boulevard, P.O. Box 2200
 Northridge, California 91329 U.S.A.

■ A Harman International Company
 © Copyright 2005 JBL Professional

SS LSR6328P
 CRP 5M
 8/05