

JBL 6021/6022 INSTALLATION AND SERVICE MANUAL

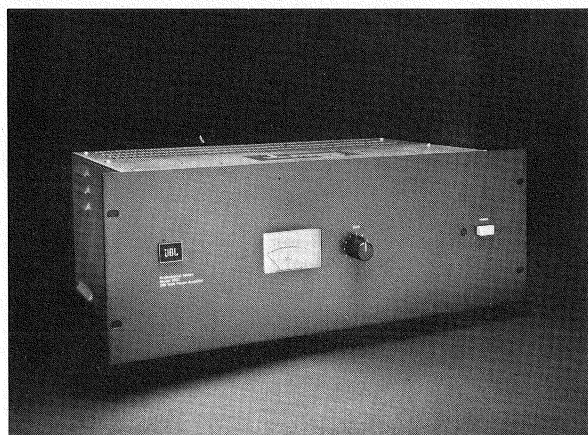

Owners Instructions

Architectural Specifications

The amplifier shall be single channel with an input gain control and an output level meter on the front panel. The amplifier shall accommodate an unbalanced high impedance input, or a balanced low impedance input with an optional plug-in accessory transformer.

The amplifier shall be capable of delivering a minimum of 200 W, continuous sine wave, 20 Hz-20 kHz, into a 4 Ω load. (6021: The amplifier shall incorporate an output transformer allowing full power operation, 35 Hz-20 kHz, into an 8 Ω, 16 Ω or 70.7 V line as well as a direct output terminal for a 4 Ω load.) (6022: No output transformer and only a direct output terminal shall be provided, but it shall be possible to install an output transformer easily at any time.)

The amplifier shall have < 0.2% THD, 20 Hz-20 kHz, @ 200 W, direct output. (6021: The amplifier shall have < 0.2% THD, 35 Hz-20 kHz, @ 200 W, transformer output.) Frequency response shall be ± 0.5 dB, 20 Hz-20 kHz, @ 1 W. Power bandwidth shall be 10 Hz-40 kHz.

Construction of the amplifier shall be modular. The entire amplifier circuit, except for the power supply (6021: and output transformer) shall be mounted on a single circuit board attached to the heat sink, which assembly shall be removable from the unit with the mainframe still mounted in a rack. Cables connecting the circuit board to the mainframe shall be of a length sufficient to allow removal of the board without disconnection and shall disconnect easily at two plugs. The amplifier shall occupy four standard EIA rack spaces and shall operate on 120/240 V AC, 50/60 Hz.

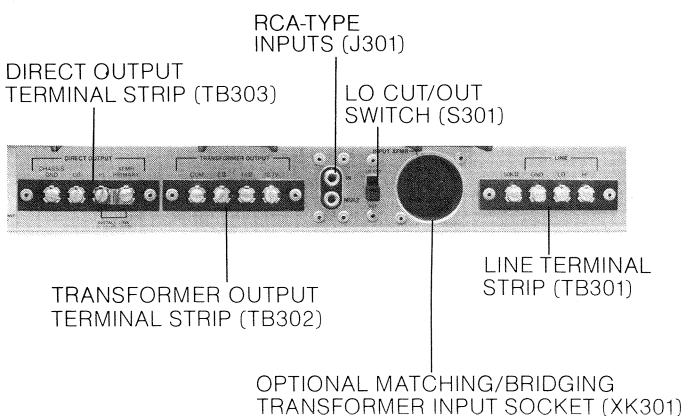
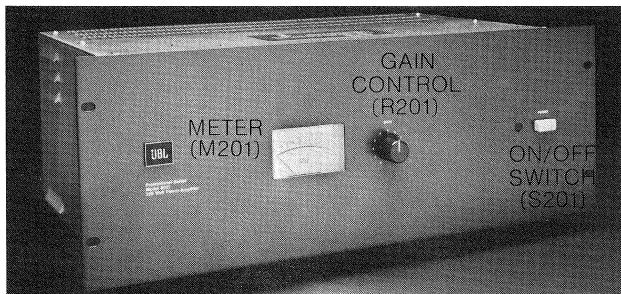

FIGURE 1

Product Specifications

Model	6022	6021
Power Output ¹		
Direct	200 W	200 W
Transformer	Optional	200 W
Power Bandwidth		
Direct—Full	20 Hz - 20 kHz, ± 0.5 dB	
— $\frac{3}{4}$	10 Hz - 40 kHz, ± 0.5 dB	
Transformer—Full		35 Hz - 20 kHz, ± 1 dB
THD ²		
Direct		< 0.2%
Transformer		< 0.2%
IM ³		
Full		< 0.2%
10 W, 0.15 W		< 0.1%
Load Impedance		
Direct	4 Ω	4 Ω
Transformer (taps)		8 Ω
		16 Ω
		25 Ω
Output Regulation		
Direct		Better than 15%
Transformer		Better than 15%
Power Gain		72 dB
Input Sensitivity		
Unbalanced (50 kΩ)		0.78 V
Balanced ⁴		0.38 V
Balanced ⁵ , ⁶		0.08 V
Signal-to-Noise Ratio ⁷		100 dB
Low-Cut Filter		6 dB/octave below 250 Hz, switchable
Power Requirements		120/240 V AC, 50/60 Hz
Power Consumption		
Quiescent		40 W
$\frac{1}{3}$ Power		275 W
Full Power		440 W
Fuse		5 A, 3 AG (120 V) 2.5 A, 3 AB (240 V)
Maximum Ambient Temp.		60°C (140°F)
Mounting EIA STD Spaces		4
Dimensions		
Front Panel		483 x 178 mm (19 x 7 in)
Depth of Controls		19 mm ($\frac{3}{4}$ in)
Depth Behind Panel		325 mm (12 $\frac{5}{16}$ in)
Net Weight	16 kg (35 lb)	22 kg (47 lb)
Shipping Weight	20 kg (44 lb)	26 kg (57.3 lb)
Accessories	JBL 5195 Matching/Bridging Transformer	JBL 60-6022 Output Transformer Assembly

- NOTES: 1. Continuous sine wave.
 2. Total harmonic distortion at rated output.
 3. SMPTE standard.
 4. 600 Ω or 15 kΩ with 5195 Matching/Bridging Transformer.
 5. 600 Ω, 14 dB step-up configuration.
 6. Requires internal modification.
 7. Requires 20 kHz equivalent bandwidth filter.

Installation

The 6021/6022 is suitable either for rack mounting in four EIA rack spaces without additional bracing or ventilation, or for counter-top placement. A full set of mounting hardware is packed with each unit. All external connections and matching/bridging transformer option are made on the rear panel, Figure 1.

Operating Temperature

Because the 6021/6022 is cooled by convection, adequate clearance on the top of the unit must be provided to allow heat dissipation. The minimum recommended clearance when stacking the unit is one EIA standard panel space.

A thermal switch in these units provides thermal protection by shutting down the amplifier if the internal temperature exceeds a safe operating level. The maximum allowable ambient temperature for the amplifier is 60°C (140°F).

Operating Controls

All operating switches, meter and level control are located on either the front panel or the rear panel, Figure 1. Control, meter and switch functions are given in Table 1.

Input Connections

Input connections to the amplifier may be either direct-coupled or transformer-isolated at the LINE terminal strip, TB301, or the RCA-type phono jacks, J301, Figure 1. Direct coupling is accomplished by connecting the center conductor of a shielded cable to LO and the shield lead to GND, or to either RCA-type

phono jack. Table 2 lists the terminals and the RCA-type phono jacks and applications of the LINE terminal strip. For transformer-isolated input, (Figure 2) must be plugged into the 9-pin receptacle, XK301, Figure 1. The input leads are connected to terminals HI, LO and GND of the LINE terminal strip.

Output Connections

Table 3 shows the output configurations available.

TABLE 1

Gain	Controls input of amplifier. Control is wired ahead of the active circuitry and can be used as an input pad to prevent overloading and clipping of the non-inverting operational amplifier stage. NOTE: When the JBL 5195 matching/bridging transformer is used, the gain control is across the output of the transformer and therefore cannot be used to prevent input transformer saturation if excess input levels occur.
Power Switch	Applies primary power to amplifier.
Meter	Provides approximation of the output level, with +3 indicating that the amplifier is delivering its rated continuous sine wave power into 4 Ω.
Low cut/out	Offers the user a response roll-off of 6 dB per octave below 250 Hz.

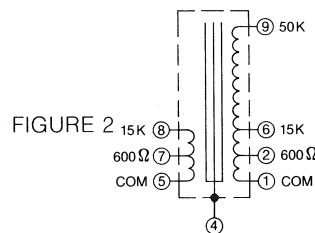

TABLE 2/TABLE 3

Terminals	RCA-Type Phono Jacks	Function	Application	Terminating Resistor	Special Instructions
50 kΩ GND		Direct Coupled	For unbalanced high impedance (50 kΩ) sources	— none —	
	"A" or "B"			— none —	
HI LO GND		Transformer isolated	Balanced high impedance (15 kΩ) source up to level of +15 dBm (with 5195 matching/bridging transformer)	— none —	
			Balanced 600 Ω source up to level of +15 dBm (with 5195 transformer)	620 Ω, ½ W, connected to terminals "HI" and "LO"	
			Balanced 600 Ω source with up to level of 4 dBm with 14 dB additional gain.	— none —	Internal modification requiring service technician.

Terminals (TB301)	Terminals (TB302)	Impedance	Direct Out	Transformer Out	Link
LO, Chassis GND		4 Ω (28.3 V)	Yes		None
	8 Ω com	8 Ω (40 V)		Yes	"HI" to "XFMR Primary"
	16 Ω com	16 Ω (56.57 V)		Yes	"HI" to "XFMR Primary"
	70.7 V com	25 Ω		Yes	"HI" to "XFMR Primary"

Service and Maintenance Instructions

The following procedures are designed to assist in the isolation of malfunctions. The operations described should be undertaken only after an investigation of all external connections and adjustments has indicated, beyond reasonable doubt, that the problem is actually within the amplifier.

WARNING: Disconnect the amplifier from the power source before performing service operations or replacing components.

Voltage Conversion

Either amplifier can be operated from either a 120 V AC or 240 V AC, 50/60 Hz source. The line voltage selector terminal strip, TB401, Figure 3, changes the primary connections of the power transformer. Use the following procedure to change the voltage range:

1. Remove the 10 screws which hold the top cover to the chassis.
2. To convert from 120 V AC to 240 V AC, remove the two terminal strip jumpers, Figure 4a. Install one jumper only per Figure 4b.
3. Change the line cord and/or attachment plug to match the supply source receptacle, or use a 120 V to 240 V AC adapter (not provided). The adapter as well as the power supply cord and/or attachment plug used for the 240 V AC mode in the U.S., Canada and Japan shall be both UL Listed and CSA Certified for use with said power source receptacle and wired per Table 4. For use in other countries, adapter, line cord and/or attachment plug selection shall be based on local regulations governing 240 V AC, 50/60 Hz supply sources.
4. Change the line fuse from a 5A, 3AG type to a 2.5A, 3AB.

FIGURE 3

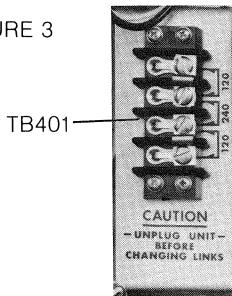

WARNING

THIS SECTION OF THE MANUAL CONTAINS SERVICE INSTRUCTIONS FOR USE BY QUALIFIED SERVICE PERSONNEL ONLY.

FIGURE 4A

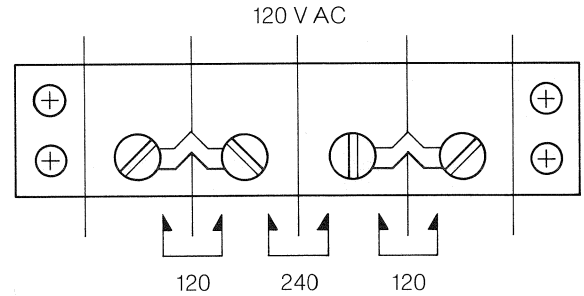

FIGURE 4B

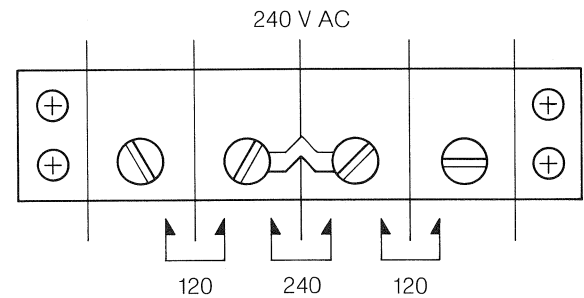
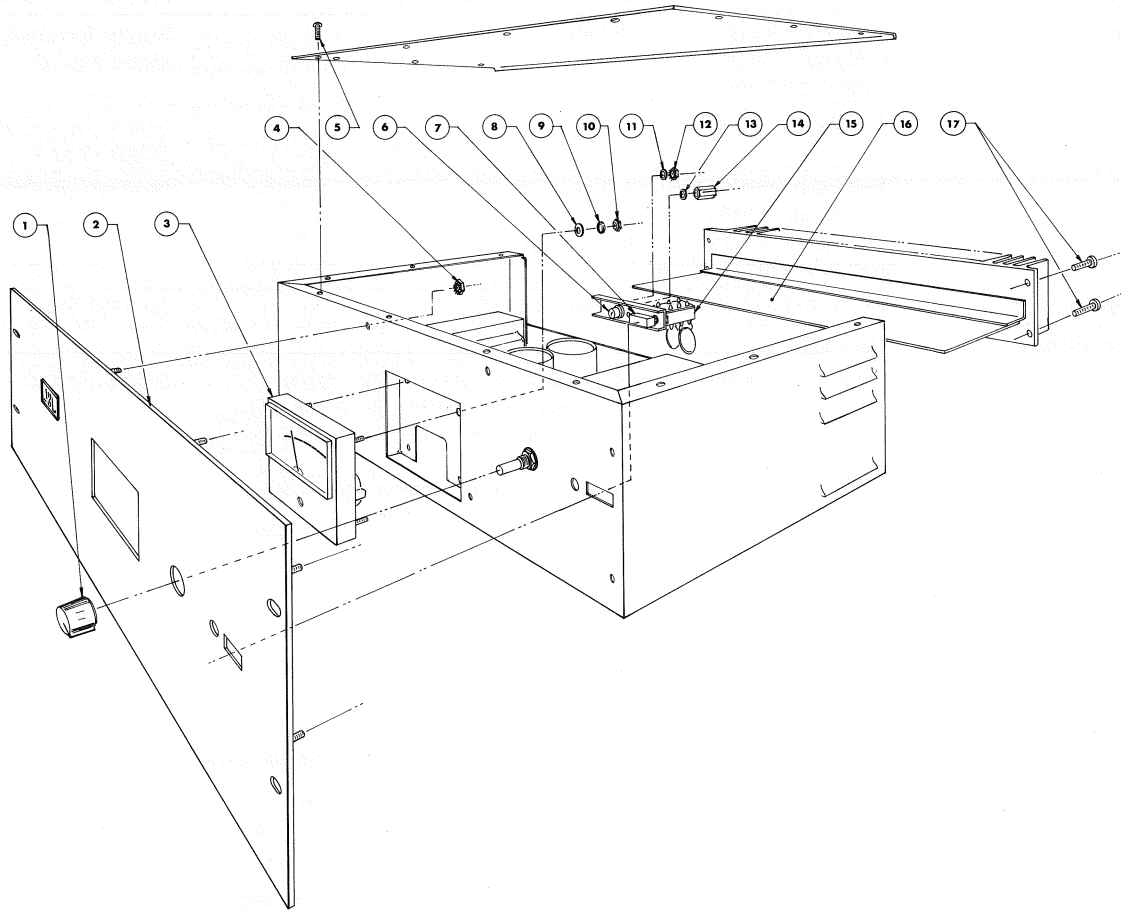

TABLE 4

Country	Wire Color Code	Line Cord Connections		
		Terminal Strip (TB401)	Fuse Holder (Center Terminal)	Ground Lug (Figure 3)
U.S., Canada and Japan	Black	—	Attached	—
	White	Attached	—	—
	Green	—	—	Attached
Europe	Blue	—	Attached	—
	Brown	Attached	—	—
	Green/Yellow	—	—	Attached

WARNING
 THIS SECTION OF THE MANUAL
 CONTAINS SERVICE INSTRUCTIONS
 FOR USE BY QUALIFIED SERVICE
 PERSONNEL ONLY.



Item	JBL Part No.	Qty.	Description
1	52886	1	knob
2	55021	1	panel
3	55098	1	meter
4	51580	7	10-32 Keps ³
5	10997	10	4-40 x 1/4 Phillips-head machine screw
6	54959	1	lamp
7	54969	1	knob
8		4	3 mm ^{1*}
9		4	3 mm ^{1*}
10		4	3 mm ^{1*}
11		1	²
12	89508	1	10-32 Keps ²
13	11908	1	No. 6 inter-tooth washer
14	54968	1	6-32 hex spacer
15	55523	1	switch
16	55037	1	power amplifier board
17	55153	4	6-32 x 1/2 hex washer head screw

*NOTES: 1. No JBL replacement for the 3 mm set.
 2. Unit may have either a Keps nut, Keps nut and washer or Keps nut, split washer and flat washer.
 3. Keps nut locked to panel stud with Loctite.

Instrument Type	Required Characteristic	Recommended Instrument
Test Oscillator	Frequency Range: 20 Hz - 20 kHz Distortion: <0.001% Output: 1 V RMS Min.	Sound Technology Model 1700 A
Distortion Analyzer	Measurable to 0.002%	Sound Technology Model 1700 A
Multimeter	Accuracy: 0.1% reading + 1 digit DC Range: ± 199.9 mV to ± 1199 V Resistance: $\pm 0.2\%$ of reading + 1 digit Input Impedance: 10 M Ω	Fluke Model 8000A
Output Load Resistors	100 W, 4 Ω and 8 Ω Non-Inductive Type, 1%	Dale NH-100
Resistor Decade Box	1 Ω - 1 k Ω Min.	
Variable Autotransformer	Capable of supplying Min. of 500 W over a range of 90 - 136 V. 1. If autotransformer does not have an AC voltmeter to indicate output voltage, monitor the output with either a multimeter or AC voltmeter. 2. If autotransformer does not have a watt meter, a watt meter capable of indicating 15 - 270 W will be required.	GenRad W5MT3W

20 kHz Equivalent
Bandwidth Filter

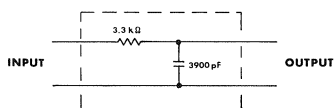

Recommended Test Equipment

The following test procedures are required after an IC, driver transistor, bias network diode, thermistor, or output device is replaced:

Bias Adjustment

Verify that the distortion at 20 kHz, 200 W, is the same as 20 kHz at 1 W and that the stable idle power is 30 - 40 W. If not, the following procedure is required:

1. Substitute resistor R37 with a decade box.
2. Adjust the amplifier for 1 W at 20 kHz.
3. Adjust the decade for minimum distortion and substitute R37 with the closest EIA standard resistor.
4. Verify distortion at 200 W and 1 W.

NOTE: Amplifier must be warm before performing distortion measurements or adjustments.

DC Offset Adjustment

Connect the multimeter to test point #2 on the circuit board. With the meter set at the lowest DC voltage range (mV), adjust the DC NULL control, R10, for a minimum DC voltage, 0 ± 25 mV.

NOTE: Amplifier must be warm before making adjustments.

Installation of Optional Output Transformer

(option on 6022)

To install the optional output transformer, Figure 5, (Model No. 60-6022):

1. Remove the heat sink/circuit board assembly.
2. Place the optional output transformer in the corner of the chassis and secure it at the four holes in the bottom of the chassis with the hardware provided.

3. Attach the Molex connector to the mating connector of the amplifier.
4. Remove the cover over the cutout for the TRANSFORMER OUTPUT terminal strip. Slip the new terminal strip of the output transformer through the cutout and orient it so that the GRAY wire is the COM. Screw the terminal strip in place with the screws that held the cover.

NOTE: If the output transformer is to be used, install a LINK between LO and HI of the DIRECT OUTPUT terminal strip, Figure 1.

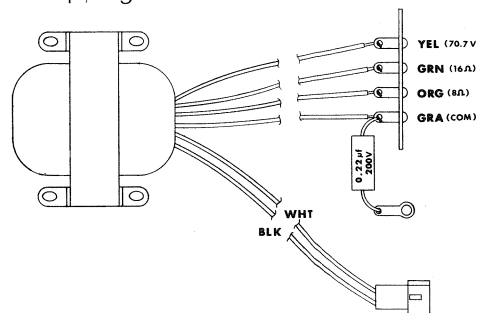

14 dB Additional Gain Conversion

14 dB of additional input sensitivity, using the optional JBL Model 5195 matching/bridging transformer, can be offered to the user by removing the RED wire connected to pin #8 of the 9-pin receptacle, XK301, and reconnecting it to pin #7.

Performance plot of a typical unit

WARNING
THIS SECTION OF THE MANUAL
CONTAINS SERVICE INSTRUCTIONS
FOR USE BY QUALIFIED SERVICE
PERSONNEL ONLY.

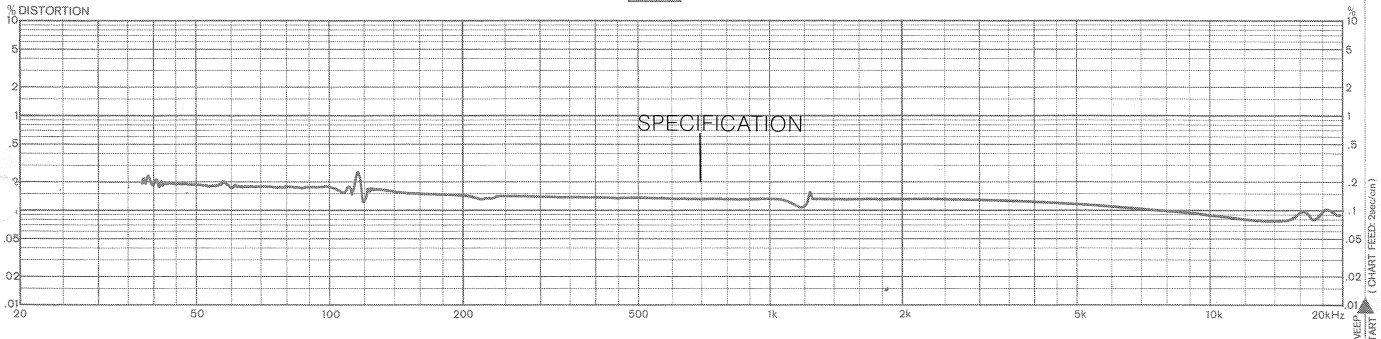
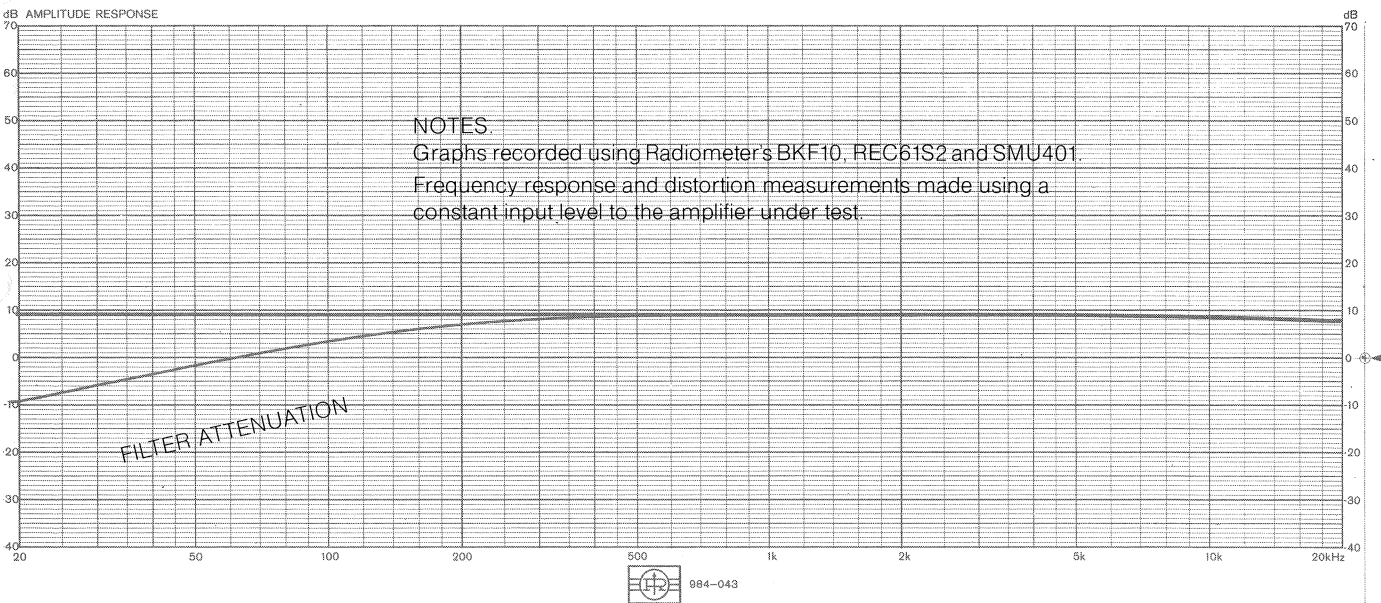
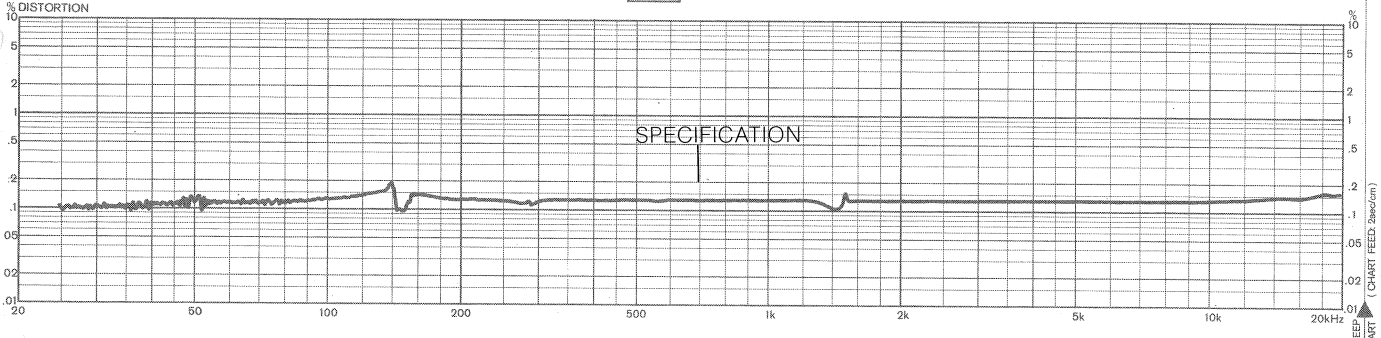
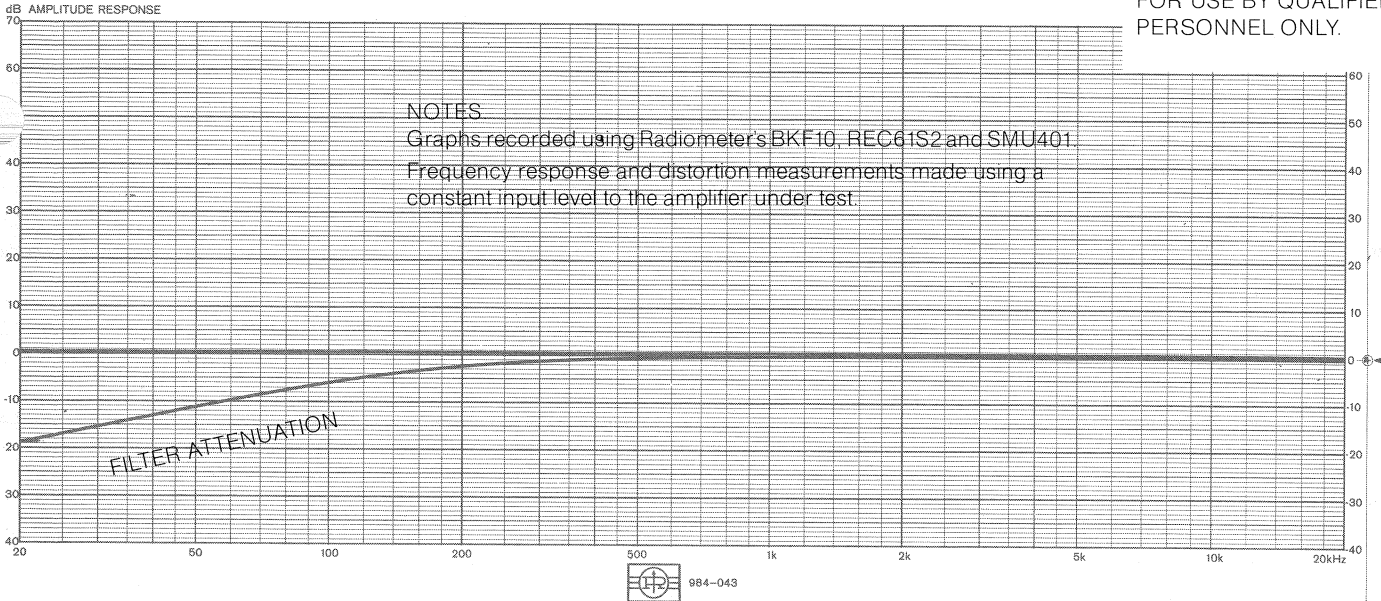

RADIOMETER COPENHAGEN	
Measuring object: <u>6011</u>	300 μ s 4 Ω
SM: <u>1485</u>	
Rec. no: <u>7/21/78</u>	
Date: <u>7/21/78</u>	
Sign: <u>Hatstein</u>	
RADIOMETER COPENHAGEN	
Measuring object: <u>6011</u>	300 μ s 4 Ω
SM: <u>1485</u>	
Rec. no: <u>7/21/78</u>	
Date: <u>7/21/78</u>	
Sign: <u>Hatstein</u>	



Professional Division

James B. Lansing Sound, Inc., 8500 Balboa Boulevard, Northridge, California 91329 U.S.A.