

KENWOOD

DUAL TRACE OSCILLOSCOPE

# CS-1044

## SERVICE MANUAL

KENWOOD CORPORATION

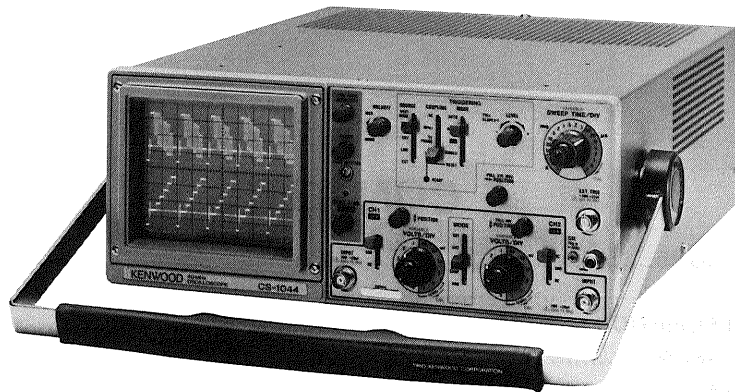

4401-20

INSTRUMENT

**WARNING**

1. The following instructions are for use by qualified personnel only. To avoid electric shock, do not perform servicing other than contained in the operating instructions unless you are qualified to do so.
  
2. High voltage up to 6000 volts dc is present when the oscilloscope is operating. Line voltage (100 to 240 VAC) is present on the power transformer, on-off switch, fuse holder, and line voltage selector any time the oscilloscope is connected to an ac power source, even if turned off. Always observe caution when the housing is removed from the unit. Contacting exposed high voltage could result in fatal electric shock.

**CONTENTS**

**SPECIFICATIONS ..... 3**

**SAFETY ..... 5**

**CIRCUIT DESCRIPTION ..... 6**

**BLOCK DIAGRAM ..... 11**

**ADJUSTMENT ..... 12**

**TROUBLESHOOTING ..... 19**

**PARTS LIST ..... 22**

**WAVEFORM OF CIRCUIT DIAGRAM ..... 30**

**SCHEMATIC DIAGRAM ..... 31**

**P.C. BOARD ..... 32**

**DISASSEMBLY ..... 35**

**SEMICONDUCTORS ..... 36**

# SPECIFICATIONS

**CRT:** 150STM31  
 Rectangular, with internal graticule

Acceleration Voltage: 6 kV  
 Display Area: 8 × 10 div (1 div = 10 mm)

**VERTICAL AXIS: CH1 and CH2**  
 Sensitivity: 1 mV/div to 5 V/div, ±3%  
 Attenuator: 12 steps, 1 mV/div to 5 V/div in 1-2-5 sequence.  
 Vernier control for fully adjustable sensitivity between steps.

Input Impedance: 1 MΩ ±2%, approx 20 pF  
 Frequency Response:  
   5 mV/div to 5 V/div: DC; DC to 40 MHz, -3 dB  
   AC; 5 Hz, to 40 MHz, -3 dB  
   1 mV/div, 2 mV/div: DC; DC to 15 MHz, -3 dB  
   AC; 5 Hz to 15 MHz, -3 dB

Rise Time: 8.8 nsec or less (40 MHz)  
 23.4 nsec or less (15 MHz)

Signal Delay Time: Approx. 20 nsec on the CRT screen

Crosstalk: -40 dB minimum  
 Operating Modes: CH1; single trace  
 CH2; single trace  
 ALT; dual trace, alternating  
 CHOP; dual trace, chopped  
 ADD; CH1 + CH2 added as a single trace

Chop Frequency: Approx. 250 kHz  
 Channel Polarity: Normal or inverted, channel 2 only inverted

 Maximum Input voltage: 500 Vp-p or 250 V (DC + AC peak)

**HORIZONTAL AXIS:** Input thru CH2, ×10 MAG not included

Operating Modes: With TRIG MODE switch, X-Y operation is selectable  
 CH1; Y axis  
 CH2; X axis

Sensitivity: Same as vertical axis (CH2)  
 Input Impedance: Same as vertical axis (CH2)  
 Frequency Response: DC; DC to 1 MHz, -3 dB  
 AC; 5 Hz to 1 MHz, -3 dB

X-Y Phase Difference: 3° or less at 100 kHz  
 Maximum Input Voltage: Same as vertical axis (CH2)

**SWEEP:**

Type: NORM: Triggering sweep  
 AUTO: Sweep free runs absence of trigger

Sweep Time: 0.2 μs/div to 0.5 s/div, ±3% in 20 ranges, in 1-2-5 sequence.

Vernier control provides fully adjustable sweep time between steps.

Sweep Magnification: ×10 (ten times) ±5%  
 (0.2 μs/div; ±8%)

Linearity: ±3% all ranges,  
 ±5% 0.2 μs/div range at ×10 MAG.

Holdoff: Continuously variable from NORM to more than ten times (MAX)

**TRIGGERING:**

Trigger mode: AUTO, NORM, SINGLE  
 Trigger source: V.MODE; Trigger selected by vertical MODE switch.  
 CH1; Triggered by CH1 signal  
 CH2; Triggered by CH2 signal  
 LINE; Triggered by line voltage  
 EXT; Triggered by signal applied to EXT TRIG INPUT jack

Coupling: AC, HFrej, TV FRAME, TV LINE

Trigger sensitivity:

	FREQ. RANGE	INT	EXT
AC	10 Hz — 40 MHz	1 div	0.1 Vp-p
AC, HFrej	Increased minimum level below 10 Hz and above 20 kHz		
TV	FRAME, LINE	1 div	0.1 Vp-p

**CALIBRATION VOLTAGE:**  
 1.0 V, ±3%, square wave, positive polarity, approx 1 kHz

**INTENSITY MODULATION:**

Sensitivity: Decreases brightness at +5.0 V

Input Impedance: Approx. 10 kΩ  
 Usable Frequency Range: DC to 2 MHz  
 Maximum Input Voltage: 50 V (DC + AC peak)

**VERTICAL AXIS SIGNAL OUTPUT: (CH1 OUTPUT)**

Output Voltage: Approx. 50 mV/div into 50 Ω  
 Output Impedance: Approx. 50 Ω

Frequency Response:  
   5 mV/div to 5 V/div: 100 Hz to 40 MHz, -3 dB into 50 Ω  
   1 mV/div, 2 mV/div: 100 Hz to 15 MHz, -3 dB into 50 Ω

# SPECIFICATIONS

## POWER REQUIREMENT

Power Supply: 100 V/120 V/220 V/240 V  
± 10%  
Line Frequency: 50/60 Hz  
Power Consumption: Approx. 36 W

## DIMENSIONS

(W × H × D): 319 (341) × 132 (145) ×  
380 (442) mm  
( ) dimensions include pro-  
trusion from basic outline  
dimensions

WEIGHT: Approx. 8 kg

## ENVIRONMENTAL:

Within Specifications: 10°C to 35°C, 85% max.  
relative humidity  
Full Operation: 0°C to 40°C, 85% max.  
relative humidity

## ACCESSORIES SUPPLIED

Probe: PC-20....2  
Spare Fuse: 0.8 A....2  
0.5 A....2  
Operators Manual: 1

\* Circuit and rating are subject to change without notice due to  
developments in technology.

# SAFETY

## SAFETY

Before connecting the instrument to a power source, carefully read the following information, then verify that the proper power cord is used and the proper line fuse is installed for power source. The specified voltage is shown at the cover of the fuse holder on the rear panel. If the power cord is not applied for specified voltage, there is always a certain amount of danger from electric shock.

### Line voltage

This instrument operates using ac-power input voltages that 100/120/220/240 V at frequencies from 50 Hz to 60 Hz.

### Power cord

The ground wire of the 3-wire ac power plug places the chassis and housing of the oscilloscope at earth ground. Do not attempt to defeat the ground wire connection or float the oscilloscope; to do so may pose a great safety hazard. The appropriate power cord is supplied by an option that is specified when the instrument is ordered.

The optional power cords are shown as follows in Fig. 4.

### Line fuse

The fuse holder is located on the rear panel and contains the line fuse. Verify that the proper fuse is installed by replacing the line fuse.

### Voltage conversion

This oscilloscope may be operated from either a 100 V to 240 V, 50/60 Hz power source. Use the following procedure to change from 100- to 240 volt operation or vice versa.

1. Replace fuse F 1 with a fuse of appropriate value, 0.8 amp for 100 VAC to 120 VAC operation, 0.5 amp for 220 VAC to 240 VAC operation.
2. When performing the reinsertion of leadwire for the voltage conversion the appropriate power cord should be used. (See Fig. 4.)



Plug configuration	Power cord and plug type	Factory installed instrument fuse	Line cord plug fuse	Parts No. for power cord and plate
	North American 120 volt/60 Hz Rated 15 amp (12 amp max; NEC)	0.8 A, 250 V Fast blow AGC/3AG	None	Cord: E30-1820-05
	Universal Europe 220 volt/50 Hz Rated 16 amp	0.5 A, 250 V Fast blow 5 x 20 mm	None	Cord: E30-1819-05
	U.K. 240 volt/50 Hz Rated 13 amp	0.5 A, 250 V Fast blow 5 x 20 mm	1 A Type C	—
	Australian 240 volt/50 Hz Rated 10 amp	0.5 A, 250 V Fast blow 5 x 20 mm	None	Cord: E30-1821-05
	North American 240 volt/60 Hz Rated 15 amp (12 amp max; NEC)	0.5 A, 250 V Fast blow AGC/3AG	None	—
	Switzerland 240 volt/50 Hz Rated 10 amp	0.5 A, 250 V Fast blow AGC/3AG 5 x 20 mm	None	—

Fig. 4 Power Input Voltage Configuration

# CIRCUIT DESCRIPTION

## Vertical Attenuator Circuit (vertical amplifier unit)

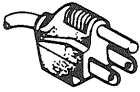
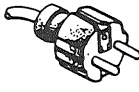
The attenuator rotary switch of channel 1 and channel 2 is a unit consisting of the switch proper containing the attenuator circuit.

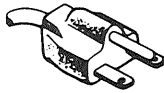
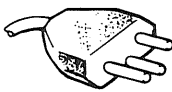
The vertical signals from the input BNC are switched by the AC-GND-DC switch and then input to the first stage attenuator circuit. These signals are then switched by the vertical rotary switch, where they pass through a 1/1, 1/10, or 1/100 attenuator, and then enter the first stage buffer amplifier.

The first stage buffer amplifier consists of Q1, 2, 3, 63, and U1 (CH2: Q4, 5, 6, 64, and U2).

The signals which enter this buffer are separated into high frequency and low frequency components. The high frequency component is impedance-converted by Q2 (Q5), and the low frequency component by U1 (U2). The respective components are recombined at the base of Q3 (Q6) and output from the emitter of this transistor. U1 (U2) is a device which has a small DC offset drift, hence the output of Q3 (Q6) is stable with respect to temperature.

The output signals are once again input to the second stage attenuator of the attenuator unit, where they are attenuated to 1/1, 1/2, 1/4, or 1/10, depending upon the attenuator setting, and then output to the second stage amplifier. Because the second stage attenuator has a low impedance, the attenuated output has good frequency response characteristics. The second stage amplifier is provided with a switch to increase the gain 5-fold when the sensitivity is 1 mV or 2 mV/div. Also, Q63 (Q64) is used as a constant current source for the load of Q2 (Q5), and Q1, D1, and D2 (Q4, D3, and D4) are used for protecting the attenuator again an excessive input.

**Adjusters:** VR1 (VR3) is used for adjusting the step attenuator balance, and VR2 (VR4) is used for low frequency gain adjustment.

## Vertical Preamplifier Circuit (vertical amplifier unit)

The signals which are output from the attenuator circuit enter the second amplifier which consists of transistor array U3 (U4). These signals then enter the base of one of a pair of transistors connected differentially, and are output as differential signals from the collectors of the respective transistors. In addition to the load resistors, these collectors are also connected to the wiper terminals of a 2-gang potentiometer belonging to the rotary switch of the attenuator. By taking off the output to the next stage amplifier from the other terminals of this potentiometer, the attenuator can provide continuously variable attenuation with good frequency characteristics. In addition, a gain selector switch is connected between the emitters of the differential transistors, and thermistor TH4 (TH5) is employed to compensate for gain drift when the sensitivity

is 1 mV or 2 mV/div.

**Adjusters:** VR5 (VR12) is used for gain adjustment when using a sensitivity of 1 mV or 2 mV/div, VR6 (VR13) is used for step attenuator balance, VR7 (VR14) is for adjusting the variable IUD balance, and TC2 (TC5) is for adjusting the amplitude of the high frequency waves.

The output from the second amplifier is input to the third amplifier which consists of the same transistor array U3 (U4). In order to maintain a high CMR ratio at this stage, the emitter load of the differential transistors is a constant current circuit. Also, to minimize the influence of transistor feedback capacitance at high frequencies, this stage is connected to the output stage as a cascode amplifier with the bases of Q7 and 8 (Q15 to 18) grounded.

In CH2, an inverse phase output is obtained by varying the base potential of Q15 and 16, and Q17 and 18, the collectors of which are cross-connected.

**Adjusters:** VR11 (VR18) and TC3 (TC6) are used for high frequency adjustment including phase compensation, VR19 is used for DC balance of the inverted CH2 output, and VR17 is used for adjusting the CH2 gain.

Next, the output of the third amplifier is input to the fourth amplifier which consists of Q9 to 14 (Q19 to 24). The fourth amplifier is also connected as a cascode circuit, and in addition the collectors of Q13 and 14 at the output on the CH1 side are connected to the collectors of Q23 and 24 on the CH2 side, and the emitters of the base-grounded Q13 and 14 (Q23 and 24) are connected to the emitters of transistors Q57 and 58 (Q59 and 60) whose bases are connected to the channel switching signals.

As a result of this configuration, output transistors Q13 and 14 (Q23 and 24) in this stage are turned ON and OFF in accordance with the level of the channel switching signals, enabling the switching operation in the vertical mode (CH1, CH2, ALT, CHOP, ADD) to take place. Also, all of the collectors of the mode switching transistors Q57 to 60 are connected to the base of transistor Q25 which supplies power to Q13, 14, 23, and 24, thus controlling fluctuations of the operating point due to mode switching. The emitters of the output transistors Q13 and 14 (Q23 and 24) of the fourth amplifier are connected to the position adjusting potentiometer VR24 (VR29) which performs position adjustment by controlling the differential current. Also, the CH1 (CH2) trigger signals and CH1OUT (X) signals are obtained from transistors Q11 and 12 (Q21 and 22) which are connected to the emitters of Q9 and 10 (Q19 and 20) at the input of this stage. These CH1OUT signals are output from the collector of Q12, then output as CH1OUT signals via a 2-stage emitter follower consisting of Q46 and 47.

**Adjusters:** VR20 (VR25) is used for adjusting the vertical position of CH1 (CH2), and VR21 and TC7

# CIRCUIT DESCRIPTION

(VR26 and TC9) are used for medium frequency adjustment including phase compensation.

VR22 is used for trigger point adjustment of CH1 and CH2 during the TRIG mode: V-mode.

VR27 is used for adjusting the X gain for X-Y.

Next, the mixed signals from the fourth amplifier output stage are input to the delay line amplifier. This amplifier is cascode-connected and consists of an emitter follower (Q26 and 27) followed by Q28 and 29, a delay line, and Q30 and 31, in that sequence. The input and output sides of the delay line are each terminated by a characteristic impedance (90 ohms per side).

**Adjusters:** VR10 is used for adjusting CH1 gain, VR30 and TC11 are for medium frequency adjustment including phase compensation, and VR33 is for CRT center adjustment.

## Vertical Output Amplifier Circuit (vertical amplifier unit)

The vertical output amplifier is a 2-stage cascode amplifier which is connected after the delay line amplifier. The output of the delay line amplifier passes through the emitter follower consisting of Q32 and 33, and is then input to the cascode amplifier Q34, 35, 36, and 37 at the first stage of the output amplifier. Thermistor TH6 is connected between the emitters of Q34 and 35 to compensate for thermal drift of the frequency characteristics, and also a long time constant RC circuit (approx. 16 seconds) is connected between the same points for compensating the square wave characteristics at ultra-low frequencies, thus compensating for the drift in the frequency characteristics of the overall vertical amplifier system and also time drift in the case of a DC input. The output of this first stage amplifier is passed through the emitter follower consisting of Q38 and 39 and then to Q40, 42, 44, and 45 of the final stage amplifier. A gain drift compensation thermistor TH3 is connected between the emitters of Q40 and 42. Also, an L type filter consisting of an L and R is connected between the collectors (output) of Q44 and 45 in order to maintain the dynamic range of the amplifier at high frequencies.

To prevent the operating point of the output amplifier from drifting, in-phase voltages are detected by resistors connected to the collectors of Q44 and 45, and any deviation from the reference voltage is fed back to the input of Q32 and 33 by means of op amp U5.

**Adjusters:** TC12 and 13 are used for adjusting the amplitude of the high frequency waves.

## Vertical Mode Logic Circuit (vertical amplifier unit + horizontal sweep unit)

The vertical mode logic circuit is divided into the vertical amplifier unit and the horizontal sweep unit, respectively. In the vertical amplifier unit is U6 which combines the CH1

and CH2 mode signals from the vertical mode switch and the X-Y signals from the horizontal sweep unit, and generates channel switching signals and trigger switching signals, and in the horizontal sweep amplifier is U5 which combines the sweep gate signals, the CHOP signals from the CHOP generator U4, and the mode signals from the vertical amplifier unit, and generates CH1 and CH2 switching enable signals.

The final channel switching signals which are generated in the above circuit are output from U6 of the vertical amplifier unit, causing the connecting and switching operations of the switching transistors Q57 and 58 (Q59 and 60) to take place.

## Trigger Signal Generator Circuit (vertical amplifier unit + horizontal sweep unit)

At the vertical amplifier unit, the trigger signals for each of CH1 and CH2 are output from the collectors of Q11 and 21, respectively, then pass through the basegrounded transistor Q61 and 62, and enter the emitters of Q51, 53, 52 and 54 of the switching circuit. Here, the trigger switching output U6 and D20 to 23 of the vertical mode logic circuit are connected to the bases of Q51 and 52, causing ON-OFF switching to take place between each of the emitted-connected transistors Q53 and 54. As a result, the selected signals are output to the collectors of Q51 and 52, amplified by Q55, and output from the emitter follower Q56 to the horizontal sweep unit.

At this time, the collectors of the switching transistors Q53 and 54 are connected to Q55 via an RC filter. The time constant of this RC filter is set to a period which is longer than the period of the low cut frequency of TRIGGER COUPLING: AC. The DC component is combined with the selected trigger signal at the base of Q55, so that the DC level of the trigger output is maintained constant regardless of the switching mode. Next, at the horizontal sweep unit, the above trigger signals are input to the TRIG-SOURCE switch together with the external sync signal which is output from the source follower and also the line trigger signal which is obtained from the power transformer, then output to an emitter follower, Q1, from a common terminal. A TRIG-LEVEL potentiometer is connected to the base of Q1 via a resistor. By adjusting this potentiometer, the DC level of the trigger signal can be selected.

In addition, the output from Q1 is input to an emitter-grounded amplifier Q2, and the output of Q2 is divided between the normal trigger signal amplifier consisting of Q3, 4, and 64, and the TV trigger signal amplifier consisting of Q7, 8, 9, and 11. It is also connected via a capacitor to Q12, which acts as a high frequency filter switch.

In the normal trigger signal amplifier, Q3 and 64 are connected as a differential pair, and Q3 and 4 are connected in cascode. Also, the TV trigger signal amplifier consists of a slope selector amplifier in which reverse phase signals are

# CIRCUIT DESCRIPTION

generated at the emitter and collector, respectively, of Q7, then selected by D5 and 6 and the SLOPE selector switch and output from emitter follower Q8, a clamping amplifier consisting of Q9 and D32, and an emitter-grounded amplifier Q11. In operation, this circuit outputs signals of the selected slope from Q8, then connects them to the base of Q9 via a capacitor, causing the signals (sync signal component of TV signals) to be clamped by Q9 and D32, thus enabling an amplified output to be obtained from the collector of Q9.

The amplified output is then passed through a TV-FRAME filter consisting of an RC circuit plus switching transistor Q13, then input to emitter-grounded amplifier Q11, and taken off from its collector. The signals which are output from the above Q4 and Q11, respectively, are selected by means of D1 to 4 and a COUPLING switch, input to Q5, and then output from emitter follower Q6.

The resulting trigger signals which are obtained are wave-shaped by a Schmitt trigger circuit consisting of ECL gate U1, and output at the ECL level.

These trigger signals are then input to an auto free-run circuit, consisting of Q15, 16, and 17, and D9 and 10, which performs signal detection by voltage doubler rectification, and also a sweep gate generator circuit consisting of flip-flop U2.

## Horizontal Sweep Circuit (horizontal sweep unit)

The sweep gate output (U2) is determined by the auto free-run circuit, Schmitt trigger circuit, and a hold-off circuit. After being level-converted by Q19, it is input to Q20 and D11, which constitute the switch of a Miller circuit.

If the input to this Miller circuit is a HIGH level, Q20 goes ON, and the input voltage of the Miller amplifier consisting of Q21 and 22 rises. As a result, the potential at the collector of Q22, which is the output of the Miller circuit, falls. When the collector potential of Q22 reaches the forward potential of D11, the emitter potential of Q20 falls, hence the output stabilizes at this point. Conversely, if the input of the Miller circuit is a LOW level, Q20 goes OFF, hence the input voltage of Q21 is determined by the time constant resistor and capacitor which were selected by the sweep rotary switch.

At this time, the collector (output) of Q22 becomes a sawtooth wave in order to maintain the input to Q21 constant, that is, it performs Miller amplification. This sawtooth wave is input to the sweep stop potential detector via Q23 and 24, and when it reaches the set level, the detected output is input to flip-flop U3. The output of this flip-flop is fed back to the sweep gate generator circuit U2, and the sweep gate is inverted, hence the Miller circuit returns to the initial reference point.

Also, the output of this flip-flop is input to the hold-off circuit consisting of Q25 to 29, 66, and 67, maintaining the specified hold-off time.

In addition, in the SINGLE sweep mode, the other flip-flop of U2 sets only data (D) equivalent to one sweep of the sweep gate flip-flop, enabling this data to be set by means of a RESET. At this time, and also during a single sweep, the READY lamp lights. In order to control the magnitude of the current which flows through the time constant resistor and capacitor, VR2 is connected, enabling the sweep time to be varied, and also VR3 is provided for controlling the hold-off time. The sweep sawtooth waveform which is generated during the above process is output from the collector of Q22 via a resistor and control potentiometer, to the horizontal amplifier circuit.

**Adjusters:** VR5 is used for adjusting the 1 mS/div sweep time (entire sweep), V4 is for adjusting the 10 mS/div sweep time (low speed), and TC1 for adjusting the 10  $\mu$ S/div sweep time (high speed).

## Horizontal Amplifier Circuit (horizontal sweep unit)

The sweep sawtooth wave is output from the collector of Q22 through a resistor and potentiometer to the emitter of a base-grounded transistor Q30. The output collector of Q30 is connected in common with the collector of Q31 used for the X signal, and in addition, one of Q30 and 31 is selected by D15, 16, and the TRIG = MODE switch.

The output of Q30 is input to the base-grounded amplifier Q32, and the output of this amplifier is fed to the horizontal output amplifier.

The horizontal output amplifier is a differential amplifier consisting of Q33 to 46. The output of Q32 is input to the input emitter follower, Q33, of the horizontal output amplifier. The input to the emitter follower Q34, which forms a pair with Q33, is connected to the horizontal POSITION potentiometer, VR10, in series with a resistor. The outputs of these emitter followers, the sawtooth wave signals, and also the horizontal position signals are input to the base of each of Q37, 38, 39, and 40 at the first stage of the output amplifier. Here, Q37 and 38 constitute the normal sweep differential amplifier, and Q39 and 40 the MAG X10 sweep differential amplifier. These are selected by the ON-OFF of the constant current power supply transistors, Q35 and 36. The emitter impedance of Q39 and 40 is 1/10th of that of Q37 and 38, and the gain is 10-fold.

The output of these first stage amplifiers is input to the final stage amplifier Q41 to 46.

The final stage amplifier is a constant current (Q45 and 46) load negative feedback amplifier. It is a power saving design which is both stable and suitable as a sawtooth wave amplifier.

**Adjusters:** TC2 is for adjusting the 0.2  $\mu$ S/div sweep time, VR7 is for adjusting the MAG center, VR8 is for adjusting the MAG gain, and TC3 is for adjusting the 20 nS/div (MAG) sweep time.



# CIRCUIT DESCRIPTION

## Blanking Circuit (horizontal sweep unit)

The output of the sweep gate (U2) is level-converted by Q47 and 48, then combined with the X-Y signals by means of the CHOP signal and D35, and output to Q50. Q50 and Q51 are emitter-connected transistors. The amplitude of the blanking signals output from the emitter is controlled by adjusting the INTENSITY potentiometer, VR11, which is connected to the base of Q51.

The blanking signals are then output to the blanking amplifier (high voltage unit).

## X-Y Circuit (vertical amplifier unit + horizontal sweep unit)

If the X-Y mode is selected during the TRIG mode, the vertical mode of the vertical amplifier unit will become "CH1", regardless of the present vertical mode. Also, X signals will be output to the horizontal sweep unit from the collector of Q22.

At the horizontal sweep unit, D33, which is connected to TRIG-MODE: X-Y, controls the sweep gate generator flip-flop U2, and stops the sweep.

Also, the X signals from the vertical amplifier are output to the horizontal amplifier circuit by Q30, 31, D15 and 16.

**Adjusters:** VR6 (horizontal sweep unit) is an X-center adjuster.

## CRT G<sub>2</sub> Bias Circuit and ASTIG Circuit (high voltage unit)

G<sub>2</sub> (2nd grid) of the CRT constitutes the reference voltage electrode of the CRT. Because it has a large influence on the sensitivity of the CRT, it is supplied with a potential at a low impedance from Q8 (high voltage unit).

The ASTIG circuit is connected to the ASTIG electrode (P<sub>2</sub>) of the CRT from the ASTIG potentiometer, VR12 (horizontal sweep unit), in series with a resistor.

## Blanking Amplifier Circuit and High Voltage Circuit (high voltage unit)

The blanking circuit is a constant current load (Q3) feedback amplifier which receives blanking signals from the horizontal sweep unit and also the external brightness modulation input. It consists of Q3, 4, 5, etc. The blanking signals are input together with the external brightness modulation input to the base of Q4, amplified by Q3 and 5, DC level-converted with reference to the cathode potential by a DC recovery circuit (D8, 10, 14, etc.), then connected to G<sub>1</sub> of the CRT. Also, the output from the blanking amplifier (collector of Q5) is passed through a feedback amplifier consisting of Q1 and 2, and an auto-focus output

obtained. This output is also passed through a DC recovery circuit consisting of D5, 6, 7, etc., where it is level-converted to a potential which is determined by the FOCUS potentiometer, and finally connected to P<sub>2</sub> of the CRT.

**Adjusters:** VR1 is used to adjust the brightness erase position.

The high voltage power supply employs a DC-DC converter.

The transformer windings of the high voltage block (W02-0425-05), which consists of a converter transformer, rectifier circuit and a CRT anode voltage multiplier (tripling) circuit, together with oscillator transistor Q7 constitute an oscillator circuit. The rectified output (-1.5 kV) from the high voltage block is applied to the cathode of the CRT, and is also connected to differential amplifier U1 via a resistor.

The deviation from the reference voltage (+10 V) of the differential amplifier is passed through Q6 to control the bias current of the oscillator, aiming at stabilizing the cathode voltage.

In addition to the cathode and anode voltages, the high voltage block supplies a CRT heater 6.3 V/95 mA output which is connected to the CRT.

## Power Supply Circuit (horizontal sweep unit)

The power supply circuit provides five stabilized voltages (+5 V, ±10 V, +60 V, and +120 V) and also two unstabilized voltages (±12 V).

Because all of the op amps (U6, 7 and 8) in the power supply circuit are used as error amplifiers and the drive transistors (Q52, 53, 54, 55, and 57) are used in a collector output configuration, the stabilized outputs are highly stable and power consumption within the power supply circuit is low.

Also, power loss in the drive transistors is minimized by current bleeder resistors connected between the emitter and collector of each output drive transistor.

The reference voltage is generated by a low thermal drift 5 V zener diode (D25). By adjusting the +10 V output, the entire stabilized output can be tracked. The non-stabilized output voltages are used for powering the illumination circuit, high voltage circuit and trace rotation circuit, which consume a large amount of current.

**Adjusters:** VR9 is a potentiometer which is used to adjust the +10 V output by comparing it with the zener voltage of D25.

# CIRCUIT DESCRIPTION

## **Calibration Voltage Generator Circuit (horizontal sweep unit)**

This is a highly stable circuit consisting of op amp U8, which is used as an oscillator, and Q63 connected as an emitter follower. The output is a square wave of approx. 1 kHz which can be varied between 0 and 1 V.

**Adjusters:** VR13 is used to adjust the amplitude of the output voltage.

## **Trace Rotation Circuit (horizontal sweep unit)**

Q61 and 62 (emitter followers) drive the rotation coil.

## **Scale Illumination Circuit (horizontal sweep unit)**

This circuit is powered by the unstabilized output ( $\pm 12$  V). It drives the illumination lamp by means of emitter follower Q59. Also, Q60 functions as a current limiter to limit the output current when the unstabilized voltage fluctuates.

# BLOCK DIAGRAM

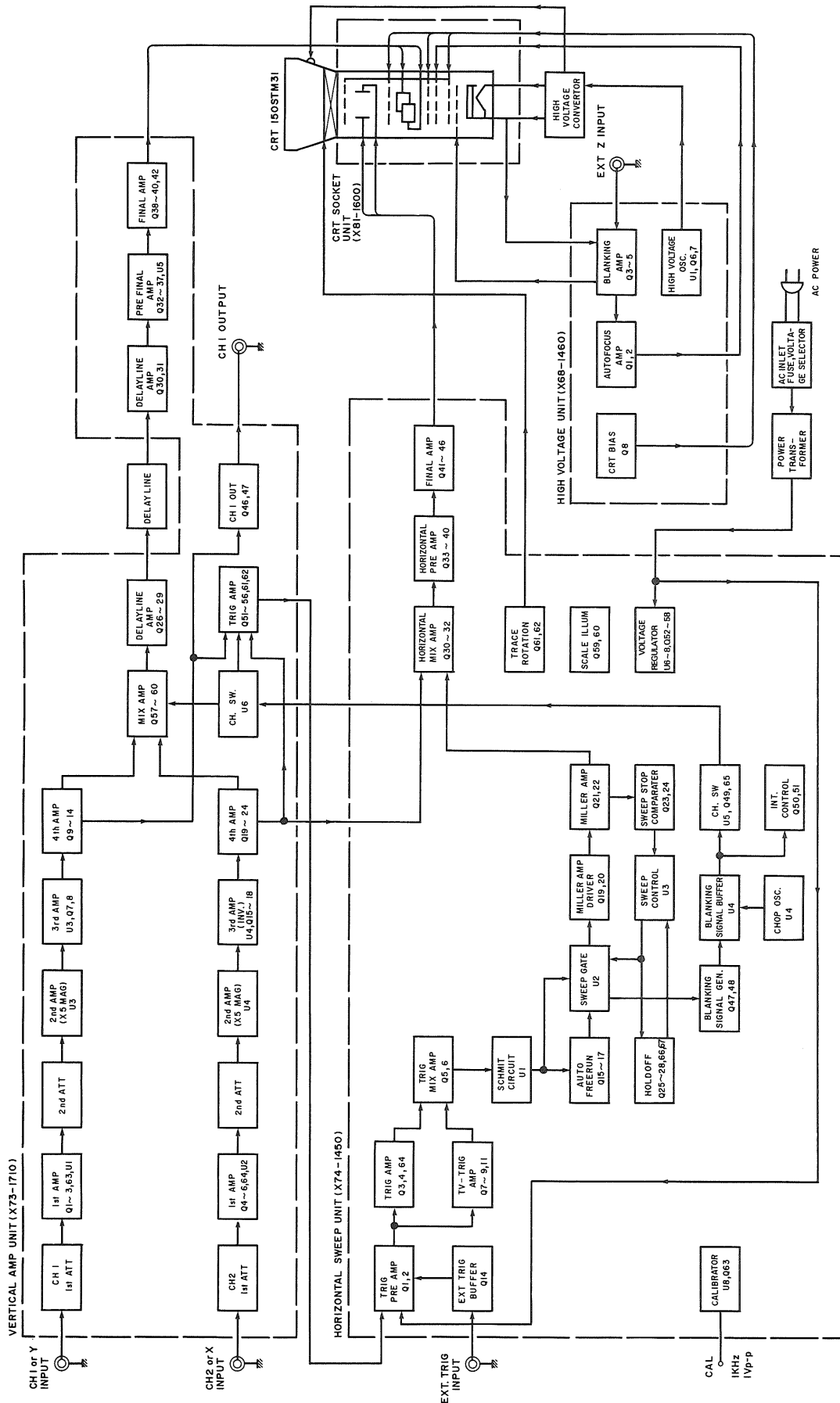

# ADJUSTMENT

To obtain the best performance, periodically calibrate the unit. Sometimes, only one mode need be calibrated, while at other times, all modes should be calibrated. When one mode is calibrated, it must be noted that the other modes may be affected. When calibrating all modes, perform the calibration in the specified sequence.

The following calibration required an accurate measuring instrument and an insulated adjusting flat blade screwdriver. If they are not available, contact your dealer. For optimum adjustment, turn the power on and warm up the scope sufficiently (more than 30 minutes) before starting.

Before calibrating the scope, check the power supply voltage.

## TEST EQUIPMENT REQUIRED

The following instrument or their equivalent should be used for making adjustment.

Test Equipment	Model	Minimum Specification
Digital Multi-Meter	DL-706 (TRIO)	Impedance: More than 10 M $\Omega$ , Measuring range: 0.01 V to 199 V
Sine-Wave Generator	651 B (YHP)	Frequency: 10 Hz to 10 MHz, constant voltage over tuning range
Sine-Wave Generator	SG-503 (Tektronix)	Frequency: 50 kHz to 100 MHz, Output impedance: 50 $\Omega$ , constant voltage over tuning range.
Square-Wave Generator	PG-506 (Tektronix)	Output signal: 1 kHz, Amplitude: 10 mVp-p to 10 Vp-p, Accuracy: within $\pm 1\%$ , Rise time: 35ns or less 100 kHz, Rise time: 1 ns or less
Q Meter	4343B (YHP)	—
Color Pattern Generator	CG-911A (TRIO)	—
Oscilloscope	CS-2110 (TRIO)	Sensitivity: more than 5 mV Frequency response: More than 100 MHz
Time-Marker Generator	TG-501 (Tektronix)	Time mark: 0.5 s to 0.1 $\mu$ s repetitive waveform
High-Voltage Probe	—	Input Impedance: 1000 M $\Omega$
Termination	—	Impedance: 50 $\Omega$ Accuracy: within 3%
Termination	—	3 watts type impedance: 50 $\Omega$
Attenuator	—	-20 dB attenuation (50 $\Omega$ )

Table 1

## PREPARATION FOR ADJUSTMENT

### Control Setting

The control setting listed below must be used for each adjustment procedure.

Exceptions to these settings will be noted as they occur.

After completing a adjustment, return the controls to the following settings.

NAME OF KNOBS	POSITION
INTENSITY	3 o'clock
FOCUS, ASTIG	Optimum position
CH1, CH2 $\nabla$ POSITION	Mechanical center
< > POSITION/PULL $\times 10$ MAG	Mechanical center, push
VARIABLE, A VARIABLE	CAL
(VOLTS/DIV, SWEEP TIME/DIV)	
AC-GND-DC (CH1 and CH2)	DC (GND at no signal)
Vertical MODE	CH1
CH2 POLARITY	NORM
COUPLING	AC
SOURCE	V.MODE
TRIG. LEVEL	Mechanical center, push
TRIG. MODE	AUTO
VOLTS/DIV (CH1 and CH2)	10 mV/DIV
A, B SWEEP TIME/DIV	1 ms/DIV
HOLD OFF	Fully CCW
B MODE	DELAY TIME ZERO

Table 2

# ADJUSTMENT

## POWER AND CRT ADJUSTMENT

### Reference voltage (+ 10 V) adjustment

1. Connect a dc voltmeter to measure the voltage at TP1 (X74-1450) with respect to the chassis.
2. Adjust VR9 for + 10 V  $\pm$  0.1 V reading on the meter.

### Reference voltage check

1. Connect a dc voltage to measure the voltage at test point (X74-1450) as shown in table 3, respectively.

Test point	TP2	TP3	TP4	TP5
Voltage	-10V $\pm$ 0.3V	60V $\pm$ 1.8V	+120V $\pm$ 3.6V	5V $\pm$ 0.15V

Table 3

2. Connect a dc voltmeter to measure the voltage at P1 (X81-1600) using a high voltage probe and check the voltage for -1.5 kV  $\pm$  0.07 kV reading on the meter.

### ASTIG and FOCUS adjustment

1. Select the TRIG MODE switch to X-Y position and both channel 1 and channel 2 AC-GND-DC switches to GND positions.
2. Pull the PULL ASTIG control and adjust the FOCUS control for the sharpest, roundest spot when centering the ASTIG and FOCUS controls.

### INTENSITY adjustment

1. Select the TRIG MODE switch to X-Y position and both channel 1 and channel 2 AC-GND-DC switches to GND positions.
2. Adjust VR1 (X68-1460) so that the trace disappears when the INTENSITY control setting is reduced to 9:30 position.
3. Clockwise rotation should increase brightness of the trace and counterclockwise rotation should decrease brightness of the trace. Fully counterclockwise should disappear the spot.

### TRACE ROTATION adjustment

1. Set the channel 1 AC-GND-DC switch to GND position.
2. Set the scope controls to display a horizontal trace with no input signal (triggering MODE switch in AUTO position).
3. Use the channel 1 position control as required to position the trace along a horizontal line of the graticule scale.
4. Adjust TRACE ROTATION control so trace is parallel with the reference line on the graticule scale.

### CRT centering adjustment

1. Short the test point TP on the vertical amp. unit (X73-1710).
2. Select auto triggering mode.
3. Adjust VR33 (X73-1710) to center the trace vertically.

## VERTICAL AXIS ADJUSTMENT

### Channel 1 and channel 2 dc balance adjustment

1. Set the scope controls for a single horizontal trace on channel 1 with the channel 1 AC-GND-DC switch set to GND position.
2. Rotate the channel 1 VOLTS/DIV switch through the 5 mV, 10 mV, 20 mV and 50 mV positions while observing the trace.
3. If the trace moves vertically, adjust VR1 (X73-1710) for minimum or zero vertical movement when performing step 2.
4. Rotate the channel 1 VOLTS/DIV switch through 1 mV, 2 mV and 5 mV positions while observing the trace.
5. If the trace moves vertically, adjust VR6 (X73-1710) for minimum or zero vertical movement when performing step 4.
6. Rotate the channel 1 VARIABLE control from maximum clockwise to maximum counterclockwise, while observing the trace.
7. If the trace moves vertically, adjust VR7 (X73-1710) for minimum or zero vertical movement when performing step 6.
8. Repeat the entire procedure, adjusting VR3, VR13 and VR14 for channel 2.

### Channel 2 invert position adjustment

1. Select CH2 mode and set the channel 2 position control to its mechanical center.
2. Pull the channel 2 position control and adjust VR19 (X73-1710) to center the trace vertically.
3. Repeat step 1 and 2 if necessary so trace does not shift when channel 2 position control is alternately pulled and pushed.

### Channel 2 position adjustment

1. Select CH2 mode and set the channel 2 position control to its mechanical center.
2. Adjust VR25 (X73-1710) to center the trace vertically.

### Channel 1 position adjustment

1. Select CH1 mode and set the channel 1 position control to its mechanical center.
2. Adjust VR20 (X73-1710) to center the trace vertically.

### 100 Hz square wave compensation

1. Using a square wave generator, apply a 100 Hz square wave signal to oscilloscope input to display a waveform of 6 divisions vertical amplitude.
2. Adjust VR2 (X73-1710) for the best flat-top waveform.
3. Repeat the entire procedure for channel 2. (VR4)

### Channel 1 gain adjustment

1. Apply a 50 mV peak to peak, 1 kHz square wave signal to channel 1 input and set the vertical MODE switch to CH1 position.

Set the scope controls to display a square wave on the 13

# ADJUSTMENT

CRT screen.

- Adjust VR10 (X73-1710) for exactly 5 divisions vertical amplitude.
- Apply a 5 mV peak to peak, 1 kHz square wave signal to channel 1 input and set the vertical MODE switch to CH1 position.  
Set the scope controls to display a square wave on the CRT screen.
- Adjust VR5 (X73-1710) for exactly 5 divisions vertical amplitude.

## Channel 2 gain and X gain adjustment

- Apply a 50 mV peak to peak, 1 kHz square wave signal to channel 2 input and set the vertical MODE switch to CH2, set the scope controls to display a square wave on the CRT screen.
- Adjust VR17 (X73-1710) for exactly 5 divisions vertical amplitude.
- Select the TRIG MODE switch to X-Y position.
- Adjust VR27 (X73-1710) for exactly 5 divisions horizontal deflection on the CRT screen.
- Apply a 5 mV peak to peak, 1 kHz square wave signal to channel 2 input and set the vertical MODE switch to CH2, set the scope controls to display a square wave on the CRT screen.
- Adjust VR12 (X73-1710) for exactly 5 divisions vertical amplitude.

## TRIGGERING ADJUSTMENT

### Vertical MODE offset adjustment

- Set the triggering SOURCE switch to VERT MODE position and vertical MODE switch to ALT position.  
Apply a 1 kHz sine wave signal to channel 1 and channel 2 input and set the scope controls to start a waveform of 6 divisions vertical amplitude from the center of the graticule scale.
- Adjust VR22 (X73-1710), if necessary so the start point of the traces have difference to channel 1 and channel 2.

## VERTICAL AXIS ADJUSTMENT

### Channel 1 and channel 2 waveshape compensation

- Apply a 1 kHz square wave signal to channel 1 input and set the scope controls to display a waveform of 6 divisions vertical amplitude.
- Adjust TC14 (X73-1710) for the best flat-top waveform when setting the channel 1 VOLTS/DIV control to 0.1 V position and TC16 (X73-1710) when channel 1 VOLTS/DIV control to 1 V position.
- Repeat the entire procedure for channel 2. (TC18, TC20)

### Channel 1 and channel 2 input capacity adjustment

- Rotate the channel 1 VOLTS/DIV control to 10 mV position and connect a Q meter to channel 1 input to measure the input capacity for  $20\text{pF} \pm 3\text{pF}$ .

X73-1710	Adjustment control	VOLTS/DIV setting
CH1/CH2	TC15/TC19	0.1 V/div
CH1/CH2	TC17/TC21	1 V/div

Table 4

- Repeat the entire procedure for channel 1 VOLTS/DIV control to 0.1 V position and 1 V position.
- Repeat the entire procedure for channel 2 input capacity adjustment.

### Channel 1 overshoot adjustment

- Apply a 1 MHz square wave signal to channel 1 input and set the scope controls to display a waveform of 6 divisions vertical amplitude.
- Adjust the following controls listed in table below. (X73-1710)

Se-quence	Adj. control	Procedure
1	TC11, VR30	Mid frequency range compensation for the best flat-top waveform.
2	VR21, TC7	Mid and high frequency ranges compensation for the best flat-top waveform.
3	VR11, TC3	High frequency range compensation for best flat-top waveform.
4	TC2	High frequency range compensation for the best flat-top waveform.
5	TC12	High frequency range compensation for the best flat-top waveform.
6	TC13	High frequency range compensation for the best flat-top waveform.
7		Repeat the entire procedure for step 2 to 6.

Table 5

### Channel 2 overshoot adjustment

- Select the vertical MODE switch to CH2 position.
- Apply a 1 MHz square wave signal to channel 2 input and set the scope controls to display a waveform of 6 divisions vertical amplitude.
- Adjust the following controls listed in table below; (X73-1710)

Se-quence	Adj. control	Procedure
1	VR26, TC9	Mid and high frequency range compensation for the best flat-top waveform.
2	VR18 TC6	High frequency range compensation for the best flat-top waveform.
3	TC5	High frequency range compensation for the best flat-top waveform.

Table 6

# ADJUSTMENT

## HORIZONTAL AXIS ADJUSTMENT

### 1 ms sweep time and MAG gain adjustment

1. Set the SWEEP TIME/DIV controls to both 1 ms positions, channel 1 VOLTS/DIV control to 1 V position.
2. Apply a 1 ms marker signal to channel 1 input.
3. Adjust VR5 (X74-1450) so the first and 11th time marks of sweep coincide with graticule scale.
4. Pull the horizontal position control.
5. Adjust VR8 (X74-1450) so the each time mark of A sweep coincides with graticule scale.

### Mag centering adjustment

1. Set the SWEEP TIME/DIV controls to 1 mV and channel 1 VOLTS/DIV to 1 V positions.
2. Apply a 5 ms marker signal to channel 1 input and set the scope controls to center the center of the A time marks (horizontal position to pushed in).
3. Adjust VR7 (X74-1450) to center the center of the time marks when again pushed in horizontal position.
4. Repeat step 2 and 3.
5. The center time mark should not shift when setting the  $\times 10$  MAG switch to on.

### 10 ms sweep time adjustment

1. Set the SWEEP TIME/DIV controls to 10 ms and channel 1 VOLTS/DIV control to 1 V positions.
2. Apply a 10 ms time marker signal to channel 1 input and set the scope controls to center the time marks.
3. Adjust VR4 (X74-1450) to center the center of time mark when again pushed in horizontal position control.

### 10 $\mu$ s sweep time adjustment

1. Set the SWEEP TIME/DIV controls to 10 ms and channel 1 VOLTS/DIV control to 1 V positions.
2. Apply a 10  $\mu$ s time marker signal to channel 1 input and set the scope controls to center the center of time marks.
3. Adjust TC1 (X74-1450) to center the center of time mark when pushed in horizontal position control.

### Sweep linearity adjustment

1. Set the SWEEP TIME/DIV controls to both 0.2  $\mu$ s and channel 1 VOLTS/DIV control to 1 V positions.
2. Apply a 0.2  $\mu$ s time marker signal to channel 1 input and the scope controls to center the center of time marks.
3. Adjust TC2 (X74-1450) to center the center of time marks when pushed in horizontal position control.
4. Set the B MODE switch to DELAY TIME ZERO, HORIZ MODE switch to ALT, A and B SWEEP TIME/DIV controls to both 1 mV and channel 1 VOLTS/DIV to 1 V positions.
5. Apply a 5 ms marker signal to channel 1 input and set the scope controls to center the center of the A and B time marks.

6. Adjust VR9 (X74-1440) to center the center of the A and B time marks when pulled out the FINE control.
7. Repeat step 2 and 3.
8. The center time mark should not shift when setting the  $\times 10$  MAG switch to on.

### X position adjustment

1. Select the vertical MODE switch to CH2 position and channel 2 AC-GND-DC switch to GND position.
2. Set the scope controls to display a trace to the graticule center.
3. Adjust VR6 (X74-1450) to position to trace to horizontal graticule when switching the TRIG MODE switch to X-Y position.
4. Clockwise rotation of channel 2 position control should move up to 5 divisions upward and counterclockwise rotation should move up to 5 divisions downward.
5. Apply a CAL signal to channel 1 input.
6. Adjust VR2 (X73-1660) for 0.5 division vertical amplitude.

# ADJUSTMENT

VERTICAL UNIT (X73-1710-00)

PANEL SIDE

X74-1450

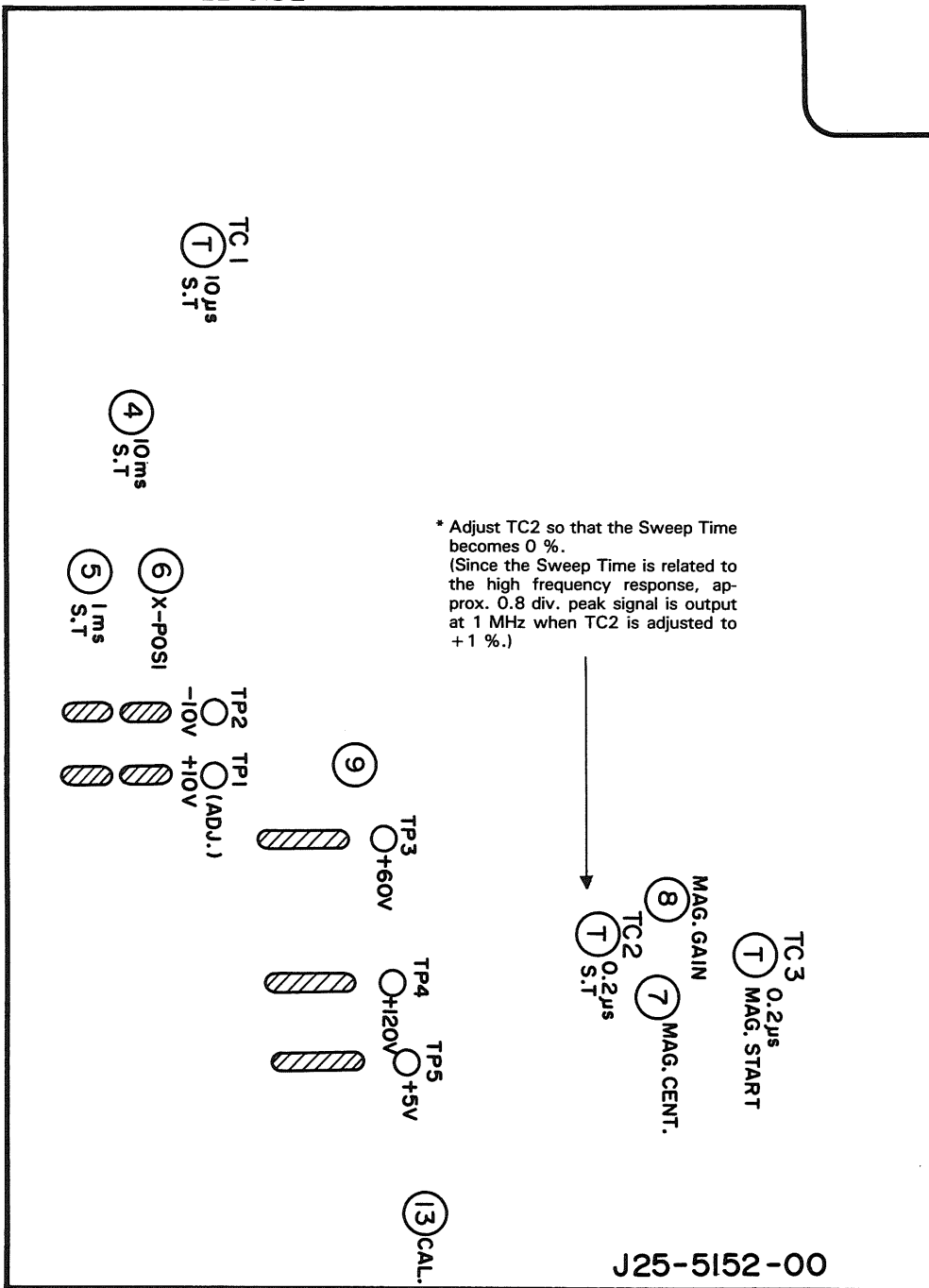



# ADJUSTMENT

HORIZONTAL UNIT (X74-1450-00)

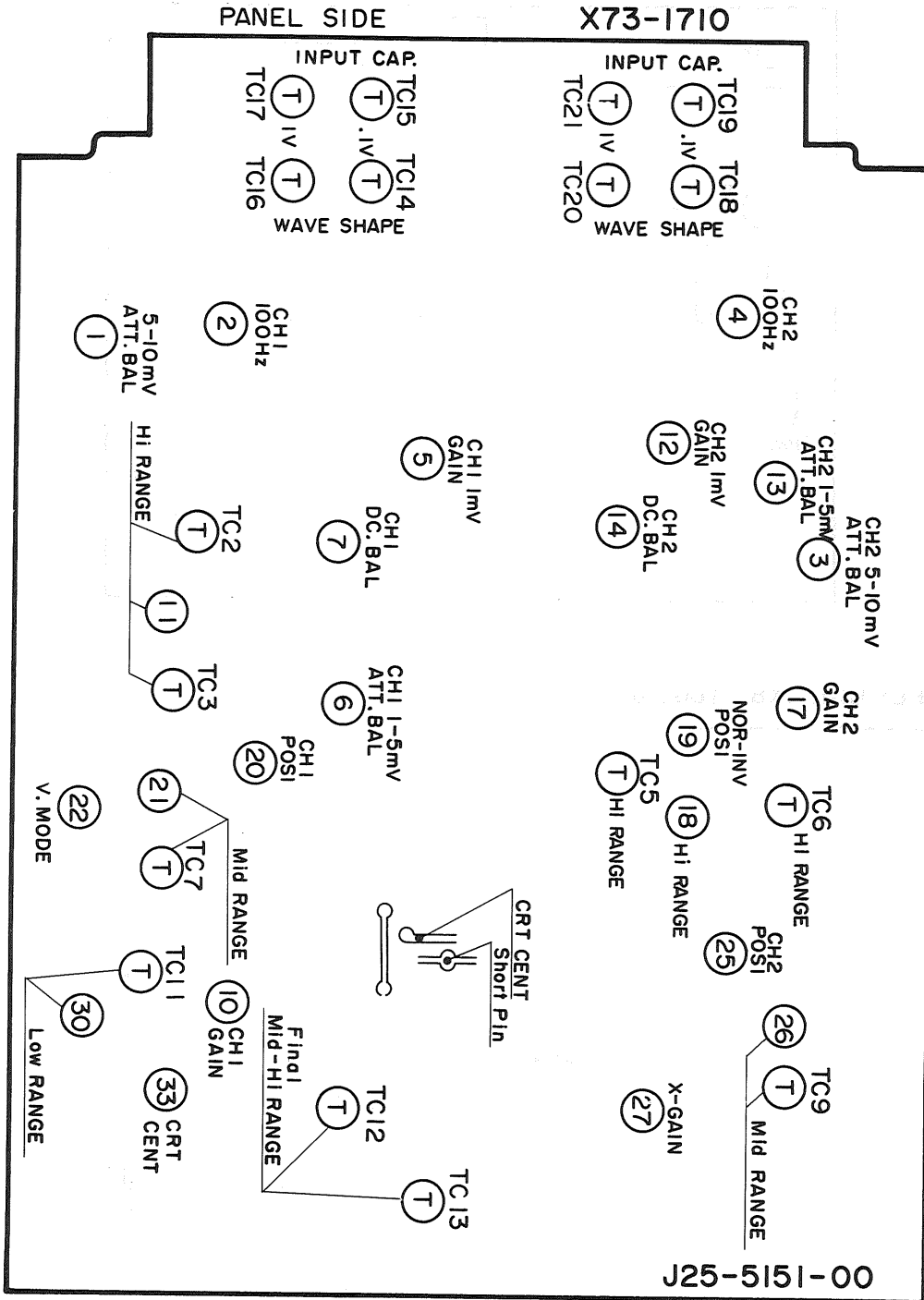

\* TC2 and TC3 are related to the frequency response of CH-1 OUT.

# ADJUSTMENT

## HIGH VOLTAGE UNIT (X68-1460-01)

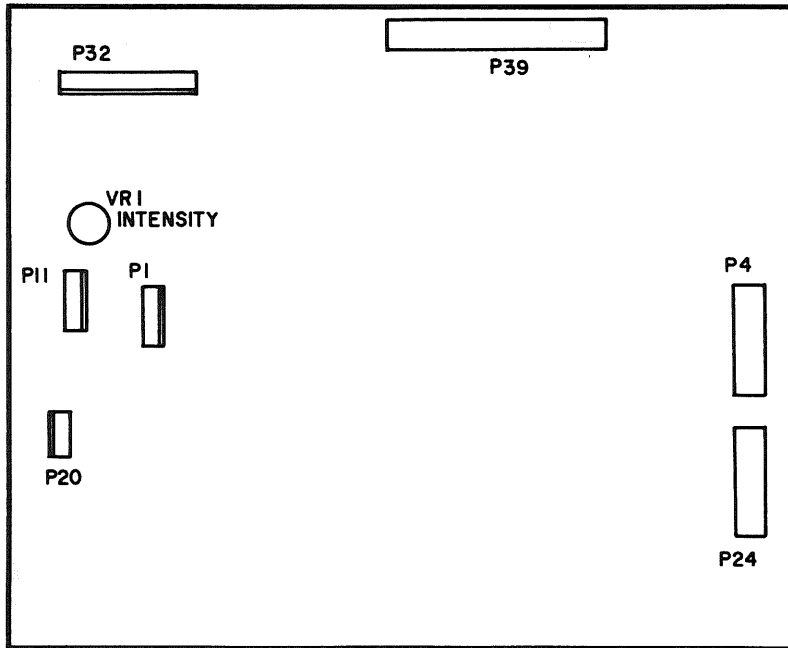

## CRT SOCKET UNIT (X81-1600-03)

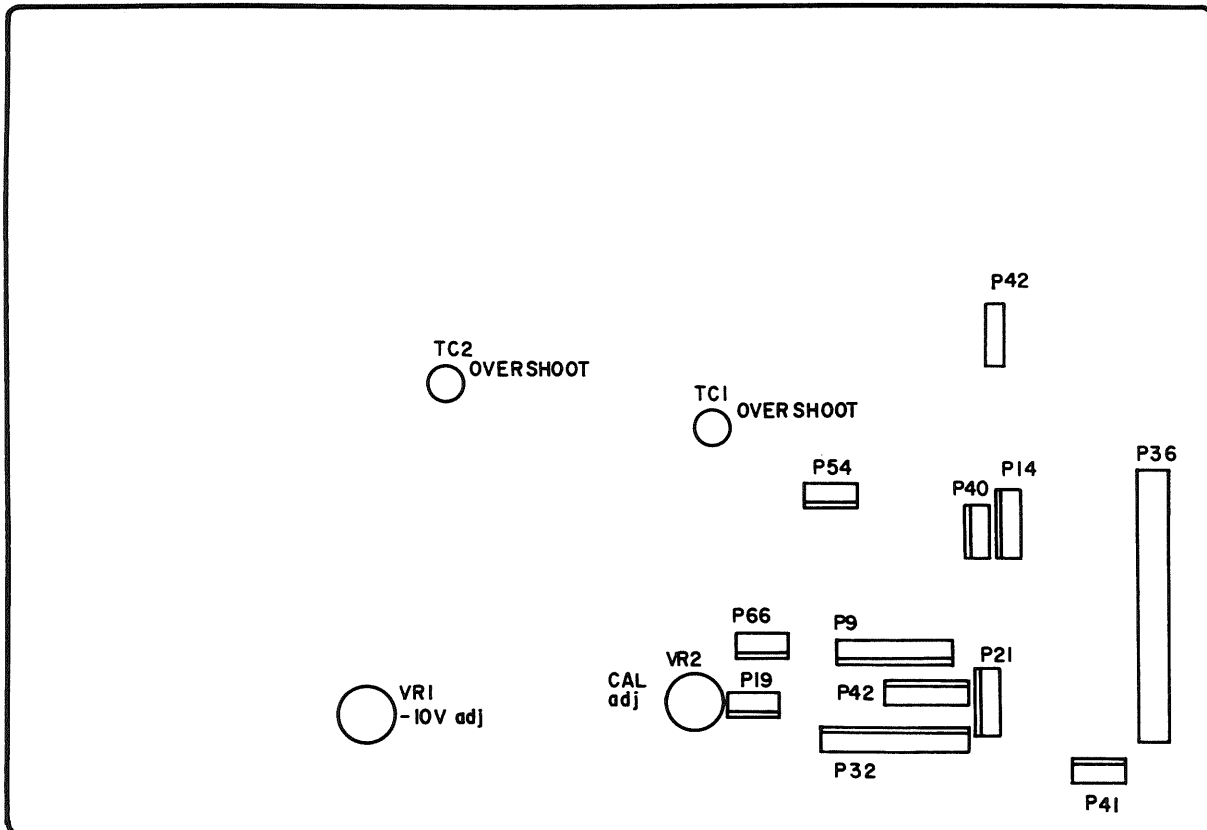

# TROUBLESHOOTING

(X73) → VERTICAL AMP UNIT  
X73-1710-00

(X74) → HORIZONTAL SWEEP UNIT  
X74-1450-00

(X68) → HIGH VOLTAGE UNIT  
X68-1460-01

(X81) → CRT SOCKET UNIT  
X81-1600-03

(At VERT1 (ALMODE: CH1, CH2, INPUT: GND),  
TRIG MODE: AUTO)

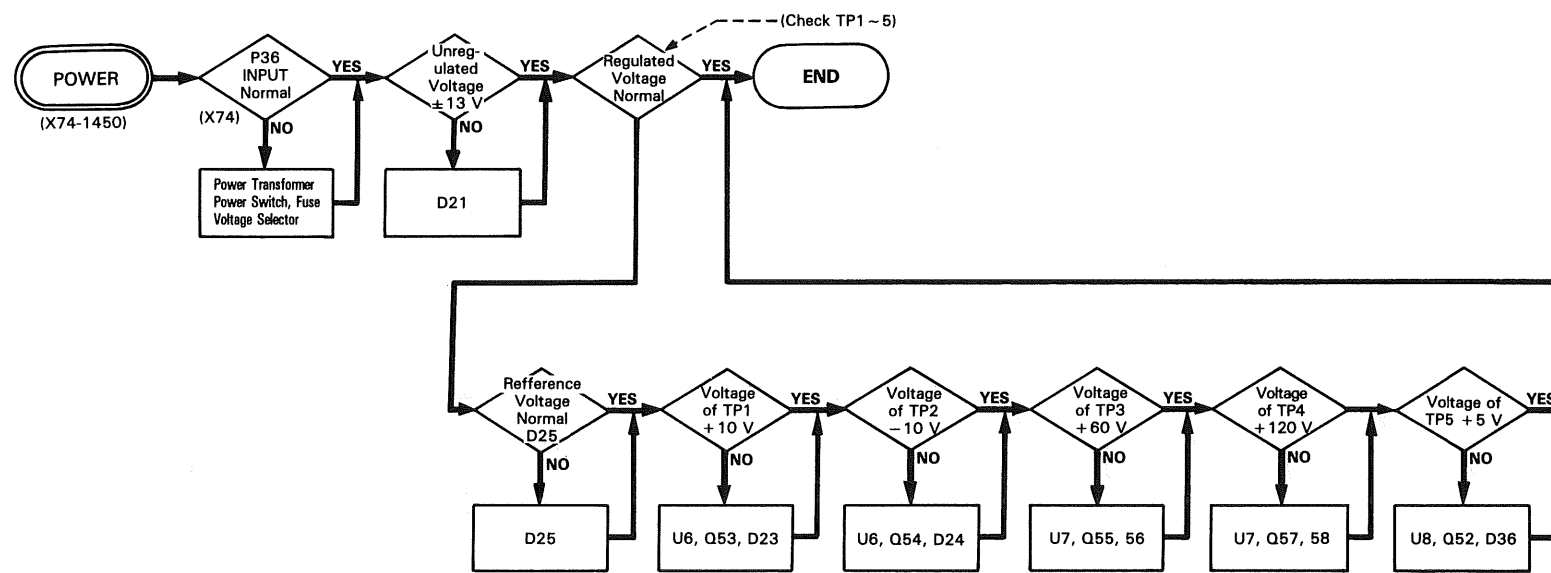
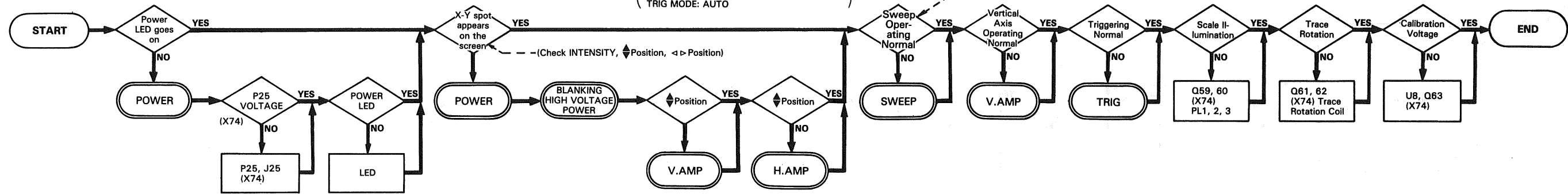

# TROUBLESHOOTING

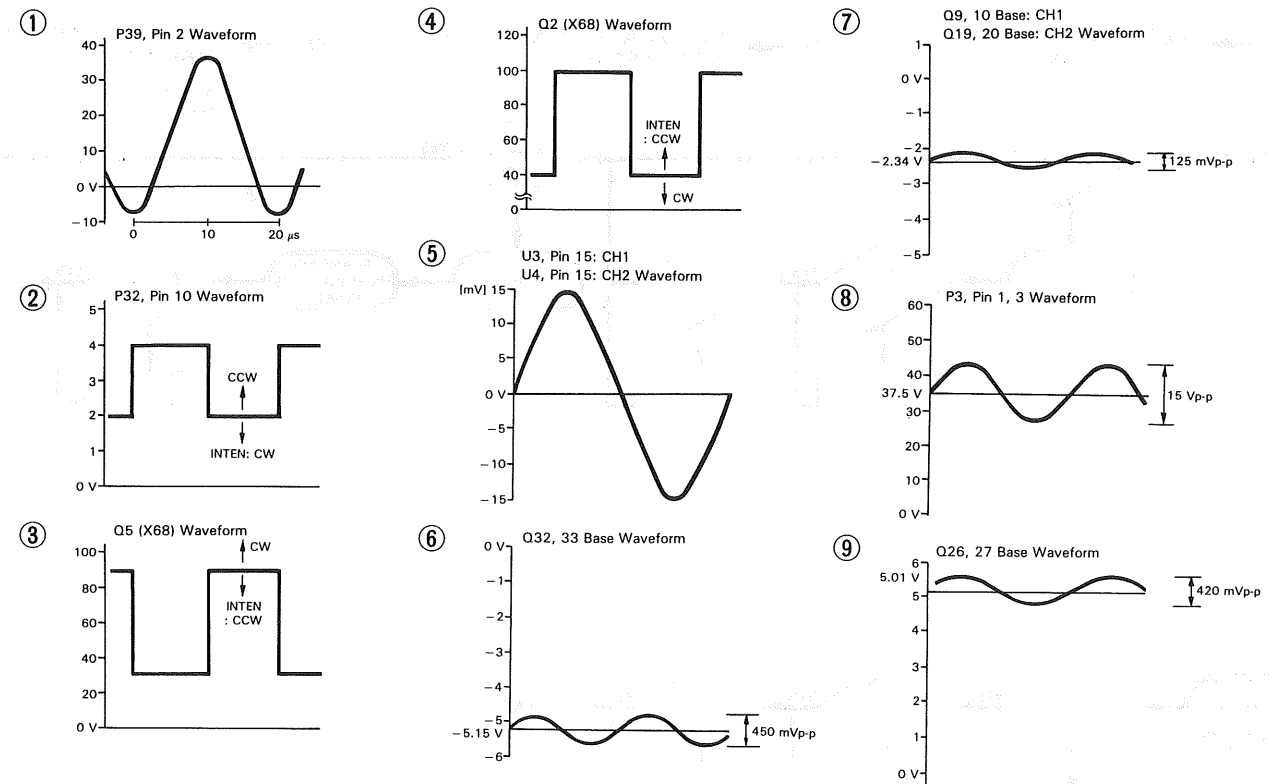
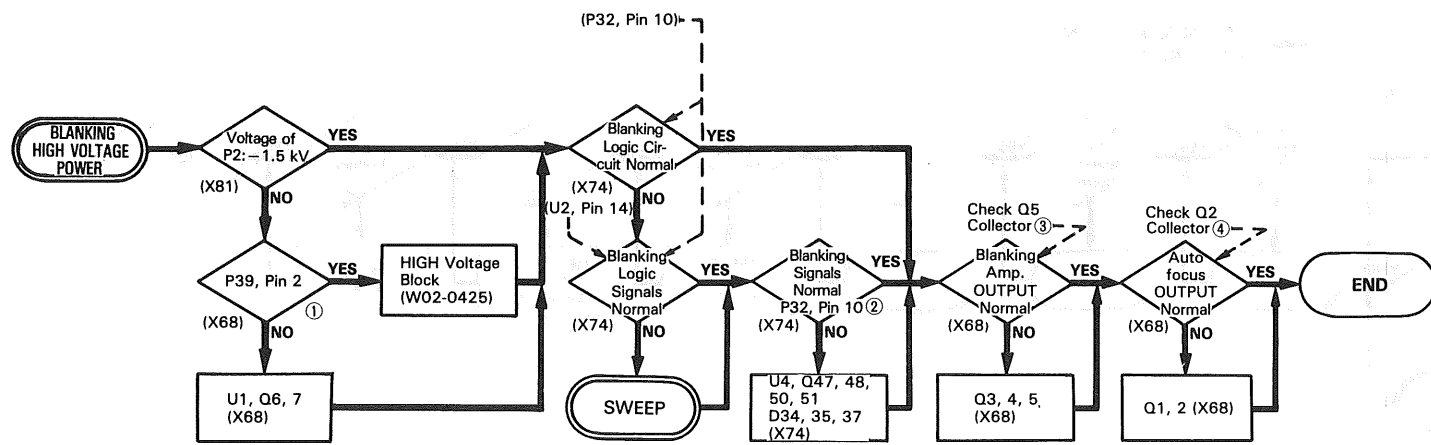

\* Condition  
Apply a sine wave signal to INPUT for 6 div vertical amplitude.

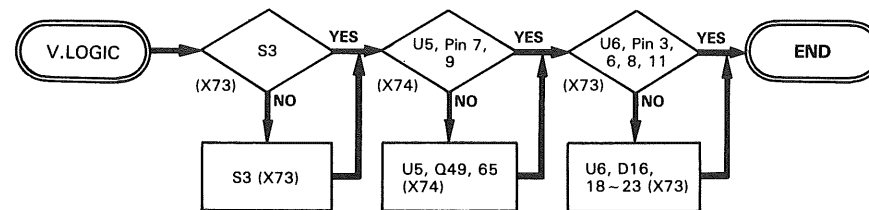
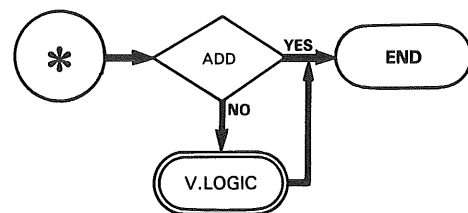
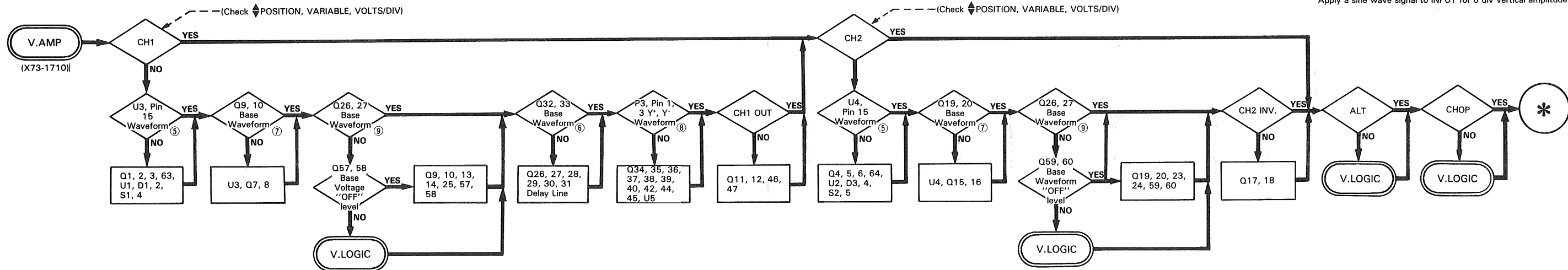

# TROUBLESHOOTING

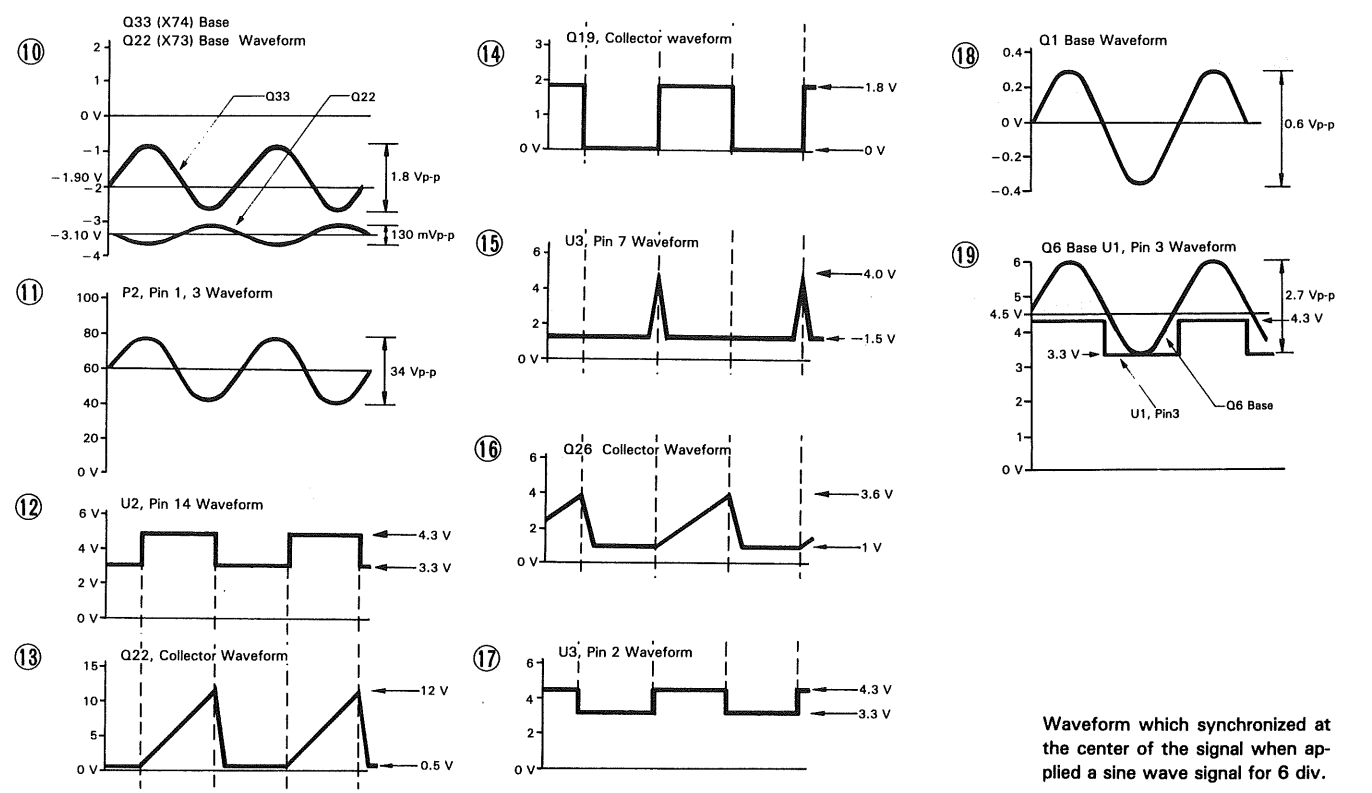
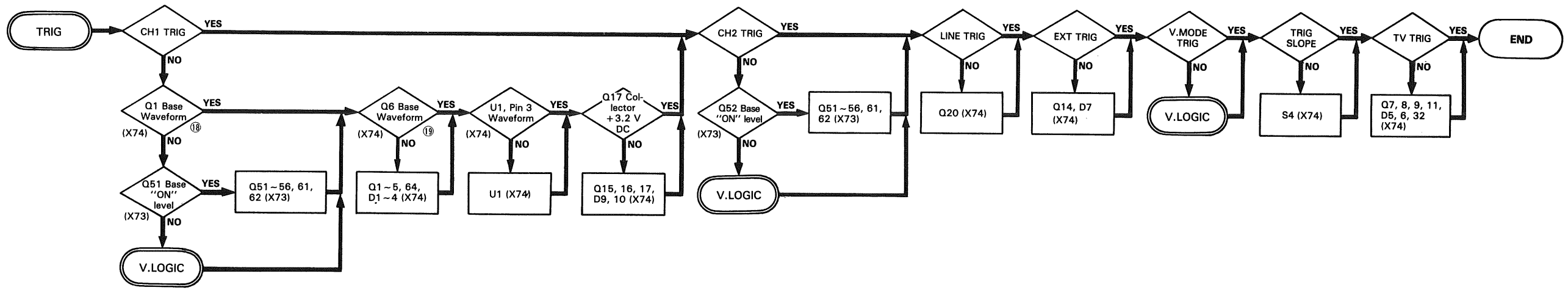
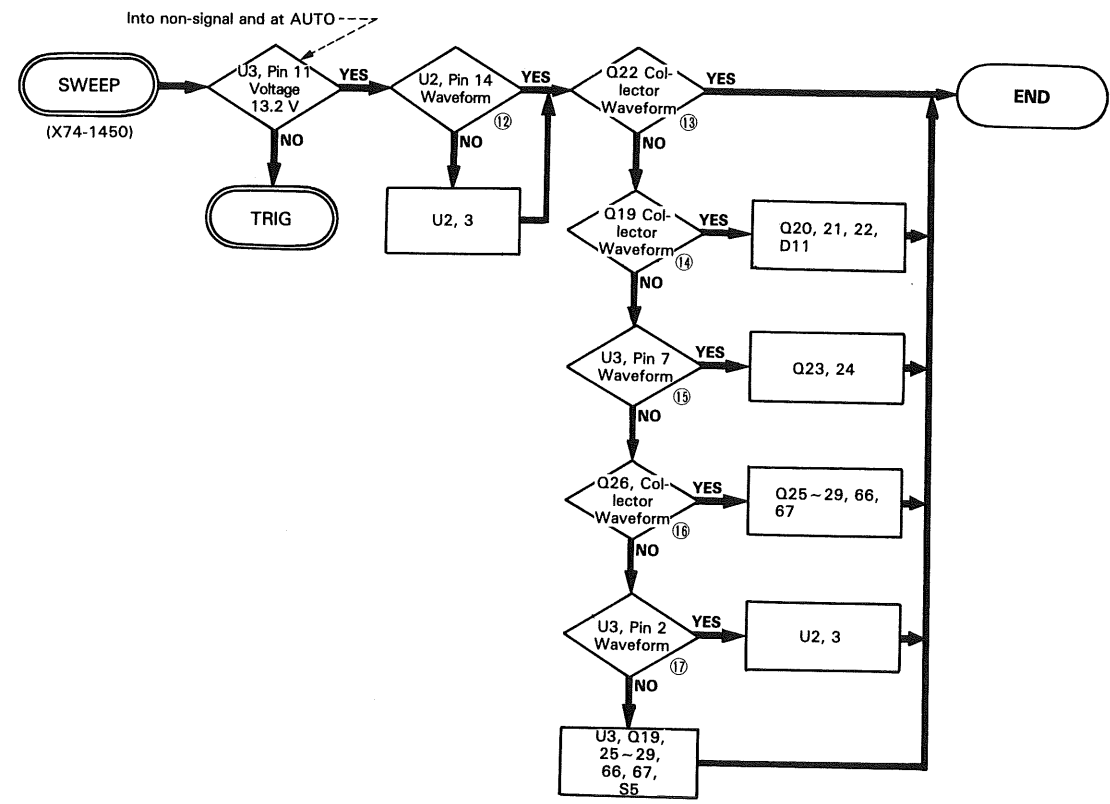
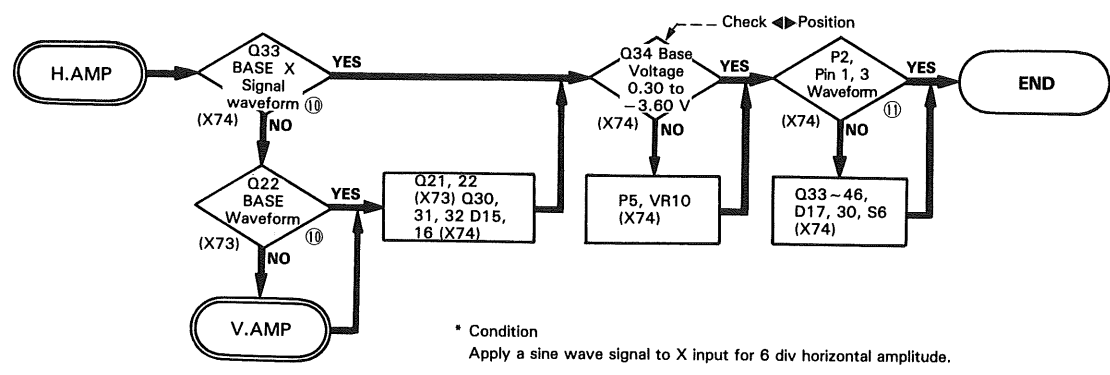

	P13 (X74)		U6 (X73)		U4 (X74)		CH. Switch Signal (X73)		TRIG. Switch Signal at V.MODE (X73)	
	5 ALT	4 CHOP	Pin 5	Pin 2	Pin 8	Pin 6	D18 Anode (CH1-E)	D19 Anode (CH2-E)	D20 Anode (CH1 Trig-E)	D22 Anode (CH2 Trig-E)
CH1	H	H	H	L	H	[Waveform]	L	H	H	L
CH2	H	H	L	H	H	[Waveform]	H	L	L	H
ALT	L	H	H	H	H	[Waveform]	[Waveform]	[Waveform]	[Waveform]	[Waveform]
CHOP	H	L	H	H		[Waveform]	[Waveform]	[Waveform]	[Waveform]	[Waveform]
ADD	H	H	H	H	H	[Waveform]	L	L	H	H
X-Y	-	-	-	L	H	-	L	H	H	L

# PARTS LIST

## CS-1044 UNIT

### Y70-1570-61

REF. NO	PARTS NO	NAME & DESCRIPTION
1	AR4133S	LBD (RED)
2	A01-1155-02	CASE
3	A01-1167-12	CASE
4	A13-0904-22	FRAME
5	A13-0906-12	FRAME
6	A13-0910-12	FRAME
7	A13-0911-02	FRAME
8	A20-2795-11	PANEL
9	A21-1093-03	DECORATIVE PANEL
10	A22-0851-32	SUB PANEL
11	A23-1670-12	REAR PANEL
12	B07-0714-03	BSCUTCHEON
13	B19-0726-04	FILTER
14	B30-0951-25	LAMP
	B40-2765-04	NAME PLATE (SERIAL NO)
15	B40-2870-03	NAME PLATE
	B41-0710-04	CAUTION LABEL (HIGH VOLTAGE)
16	B41-0789-13	CAUTION LABEL
	B50-7583-30	INSTRUCTION MANUAL
17	D19-0908-03	EXTENSION SHAFT
18	E04-0257-05	BNC RECEPTACLE
19	E18-0365-05	INLET SOCKET
20	E21-0660-04	TERMINAL (CAL)
21	E21-0667-05	TERMINAL
22	E23-0018-04	EARTH LUG
	E23-0042-04	EARTH LUG
23	E23-0513-05	EARTH LUG
	E23-0552-04	G. TERMINAL
24	E23-0561-14	G. TERMINAL
	E30-1819-05	CBE CORD
	E31-0564-05	LEAD WIRE WITH CONNECTOR
	E31-0717-05	LEAD WIRE WITH CONNECTOR
	E31-2630-05	LEAD WIRE WITH CONNECTOR
	E31-2668-05	LEAD WIRE WITH CONNECTOR
	E31-2678-05	LEAD WIRE WITH CONNECTOR
	E31-2734-05	LEAD WIRE WITH CONNECTOR
	E31-2735-05	LEAD WIRE WITH CONNECTOR
	E31-2736-05	LEAD WIRE WITH CONNECTOR
	E31-2737-05	LEAD WIRE WITH CONNECTOR
	E31-2738-05	LEAD WIRE WITH CONNECTOR
	E31-2739-05	LEAD WIRE WITH CONNECTOR
	E31-2740-05	LEAD WIRE WITH CONNECTOR
	E31-2741-05	LEAD WIRE WITH CONNECTOR
	E31-2742-05	LEAD WIRE WITH CONNECTOR
	E31-2743-05	LEAD WIRE WITH CONNECTOR
	E33-4107-00	WIRE ASSY
	F05-5013-05	FUSE 0.5A
25	F05-8015-05	FUSE 0.8A
	F07-0908-14	PROTECTION COVER
26	F10-1567-14	SHIELD PLATE
27	F10-1593-14	SHIELD PLATE
28	F11-0996-04	SHIELD CASE
29	F11-0998-03	SHIELD CASE
30	F15-0740-04	BLIND PLATE
31	F15-0741-14	BLIND PLATE
	F20-0658-04	INSULATOR
32	G01-0909-04	COIL SPRING
33	G02-0606-14	SPRING FOR HANDLE
	G16-0609-04	RUBBER SHEET
34	G16-0611-04	RUBBER SHEET
35	G16-0612-04	RUBBER SHEET
36	G16-0614-04	RUBBER SHEET
	H01-5804-14	CARTON BOX
	H10-2832-02	FOAMED STYRENE PAD
	H10-2833-02	FOAMED STYRENE PAD
	H12-0564-04	PAD
	H20-1719-04	VINYL COVER
	H25-0016-00	BAG
	H25-0029-04	POLYETHYLENE BAG (FUSE)
37	J02-0089-05	RUBBER LEG
38	J10-0409-02	BEZEL
	J19-1620-05	CORD CLAMP
	J19-1622-05	CORD CLAMP
39	J19-1635-04	HOLDER FOR LBD
40	J19-1645-24	BRACKET
41	J19-1646-04	BRACKET
42	J21-2906-05	GEAR FOR HANDLE
43	J21-2907-05	RING FOR HANDLE
44	J21-4562-03	BRACKET FOR CRT
45	J31-0608-05	COLLAR
46	J32-0849-04	BOSS

REF. NO	PARTS NO	NAME & DESCRIPTION
47	J42-0528-05	BUSHING
48	J59-0403-05	NYLON RIVET
49	J61-0049-05	WIRE BAND
	J61-0408-05	WIRE WRAPPING BAND
	J61-0522-05	WIRE WRAPPING BAND
50	K01-0524-15	HANDLE
51	K21-0860-13	KNOB
52	K21-0885-03	KNOB
53	K21-0888-04	KNOB
54	K23-0803-13	KNOB
55	K27-0530-14	KNOB
56	L01-9596-05	POWER TRANSFORMER
57	L39-0524-05	COIL
58	L76-0110-05	DELAY LINE
59	N08-0611-04	DRESSED SCREW
60	N09-0623-04	SCREW
61	N09-0705-05	SCREW, HEX SOCKET FLAT HD
62	N09-0709-05	SCREW
63	N09-0726-05	SCREW
64	N09-0731-05	SCREW
65	N09-0739-05	SCREW
	N10-2030-46	NUT, HEX
66	N14-0602-34	NUT
67	N14-0624-04	NUT
68	N14-0625-04	NUT
69	N15-1030-41	WASHER, FLAT FOR M3
	N17-1030-41	LOCK WASHER
70	N19-0710-05	WASHER
71	N19-0725-04	WASHER
72	N30-3035-46	SCREW, PAN HD M 3X35
73	N32-3006-41	SCREW, FLAT HD M 3X6
74	N32-3008-41	SCREW, FLAT HD M 3X8
75	N34-3012-41	SCREW, TRUSS M 3X12
76	N88-3008-41	SCREW, FLAT HD TAP TITE
77	N89-3006-41	SCREW, BINDING TAP TITE
78	N89-3008-41	SCREW, BINDING TAP TITE
79	N89-3010-41	SCREW, BINDING TAP TITE
80	N89-3016-46	SCREW, BINDING TAP TITE
	R014BB2E220J	RES. CARBON 22 5% 1/4W
81	R03-1509-05	V.R. 10K B
82	R05-3505-05	V.R. 20K B
83	R05-8001-05	V.R. 3M B
84	W01-0503-04	CORD WRAP
85	W02-0425-05	HIGH VOLTAGE POWER BLOCK
86	X68-1460-01	HIGH VOLTAGE UNIT
87	X73-1710-00	VERTICAL AMP UNIT
88	X74-1450-00	HORIZONTAL SWEEP UNIT
89	X81-1600-03	CRT SOCKET UNIT
	Y87-2260-00	PROBE PC-30
90	150STM31	CRT
	Z12-3017-05	TUBE (PLASTIC)

## CRT SOCKET UNIT

### X68-1460-01

REF. NO	PARTS NO	NAME & DESCRIPTION
	E31-2170-05	JUMPING WIRE
	F01-0813-05	HEAT SINK
	F15-0727-04	HOLDER (NEON TUBE)
	J25-5101-03	PCB (UNMOUNTED)
	N30-3006-46	SCREW, PAN HD M 3X6
C001	CC45CH1H200J	CAP. CERAMIC 20P 5% 50V
C002	CC45CH1H050C	CAP. CERAMIC 5P 0.25P 50V
C003	CC45CH2H010C	CAP. CERAMIC 1P 0.25P 500V
C004	CC45CH2H010C	CAP. CERAMIC 1P 0.25P 500V
C005	CC45CH2H030C	CAP. CERAMIC 3P 0.25P 500V
C006	CC45CH2H010C	CAP. CERAMIC 1P 0.25P 500V
C007	CK45B2H472K	CAP. CERAMIC 4700P 10% 500V
C008	C90-0298-05	CAP. CERAMIC 0.1 20% 12V
C009	CK45B2H472K	CAP. CERAMIC 4700P 10% 500V
C010	C90-0298-05	CAP. CERAMIC 0.1 20% 12V
C011	C91-0571-05	CAP. CERAMIC 0.01 2KV
C012	NO USE	
C013	C91-0571-05	CAP. CERAMIC 0.01 2KV
C014	C91-0571-05	CAP. CERAMIC 0.01 2KV
C015	CE04W1E010M	CAP. ELECTRO 1 250V
C016	C91-0571-05	CAP. CERAMIC 0.01 2KV
C017	C91-0571-05	CAP. CERAMIC 0.01 2KV
C018	C91-0571-05	CAP. CERAMIC 0.01 2KV
C019	CK45B2H102K	CAP. CERAMIC 1000P 10% 500V
C020	CK45B3D102P	CAP. CERAMIC 1000P 2K
C021	CQ92FM1H154K	CAP. MYLAR 0.15 10% 50V
C022	CQ92FM1H154K	CAP. MYLAR 0.15 10% 50V
C023	NO USE	

# PARTS LIST

REF. NO	PARTS NO	NAME & DESCRIPTION
C024	CQ92FM1H103K	CAP. MYLAR 0.01 10% 50V
C025	CK45B1H472K	CAP. CERAMIC 4700P 10% 50V
C026	C91-0571-05	CAP. CERAMIC 0.01 2KV
C027	C91-0571-05	CAP. CERAMIC 0.01 2KV
C028	CK45B2H102K	CAP. CERAMIC 1000P 10% 500V
C029	CK45B2H472K	CAP. CERAMIC 4700P 10% 500V
C030	CE04W1E101M	CAP. ELECTRO 100 20% 25V
C031	CE04W1E101M	CAP. ELECTRO 100 20% 25V
C032	CE04W1E101M	CAP. ELECTRO 100 20% 25V
C033	CE04W1E101M	CAP. ELECTRO 100 20% 25V
C034	CE04W2C3R3	CAP. ELECTRO 3.3 160V
C035	CK45B2H472K	CAP. CERAMIC 4700P 10% 500V
D001	1SS132	DIODE
D002	NO USE	
D003	1SS132	DIODE
D004	1SS83	DIODE
D005	1SS83	DIODE
D006	1SR35-200	DIODE
D007	1SR35-200	DIODE
D008	1SS83	DIODE
D009	1SS83	DIODE
D010	1SR35-200	DIODE
D011	1SS132	DIODE
D012	1SS132	DIODE
D013	1SS132	DIODE
D014	1SR35-200	DIODE
L001	L40-1011-13	FERRI INDUCTOR 100UH
L002	L40-1011-13	FERRI INDUCTOR 100UH
NL001	NE-2B	NEON LAMP
NL002	NE-2B	NEON LAMP
NL003	NE-2B	NEON LAMP
NL004	NE-2B	NEON LAMP
P001	E40-0373-05	PIN CONNECTOR 3 P
P004	E40-0332-05	PIN CONNECTOR 3 P
P011	E40-0373-05	PIN CONNECTOR 3 P
P020	E40-0273-05	PIN CONNECTOR 2 P
P024	E40-0332-05	PIN CONNECTOR 3 P
P032	E40-0873-05	PIN CONNECTOR 8 P
P039	E40-0703-05	PIN CONNECTOR 7 P
Q001	2SA1207(S)	TR. SI, PNP
Q002	2SC2909(S)	TR. SI, NPN
Q003	2SA1207(S)	TR. SI, PNP
Q004	2SA1175(F)	TR. SI, PNP
Q005	2SC2909(S)	TR. SI, NPN
Q006	2SA1175(F)	TR. SI, PNP
Q007	2SD613(E)	TR. SI, NPN
Q008	2SC2909(S)	TR. SI, NPN
R001	RD14BB2H103J	RES. CARBON 10K 5% 1/2W
R002	RD14BB2C332J	RES. CARBON 3.3K 5% 1/6W
R003	RD14BB2C472J	RES. CARBON 4.7K 5% 1/6W
R004	RD14BB2C622J	RES. CARBON 6.2K 5% 1/6W
R005	RD14BB2E104J	RES. CARBON 100K 5% 1/4W
R006	RD14BB2E104J	RES. CARBON 100K 5% 1/4W
R007	RD14BB2E823J	RES. CARBON 82K 5% 1/4W
R008	RD14BB2C152J	RES. CARBON 1.5K 5% 1/6W
R009	RD14BB2C124J	RES. CARBON 120K 5% 1/6W
R010	RD14BB2C332J	RES. CARBON 3.3K 5% 1/6W
R011	RD14BB2C102J	RES. CARBON 1K 5% 1/6W
R012	RD14BB2C104J	RES. CARBON 100K 5% 1/6W
R013	RD14BB2C124J	RES. CARBON 120K 5% 1/6W
R014	RD14BB2C332J	RES. CARBON 3.3K 5% 1/6W
R015	RD14BB2C103J	RES. CARBON 10K 5% 1/6W
R016	RD14BB2C102J	RES. CARBON 1K 5% 1/6W
R017	RD14BB2C221J	RES. CARBON 220 5% 1/6W
R018	RD14BB2C470J	RES. CARBON 47 5% 1/6W
R019	RD14BB2E334J	RES. CARBON 330K 5% 1/4W
R020	R92-1034-05	RES. METAL FILM 47M 5% 1/2W
R021	RD14BB2E334J	RES. CARBON 330K 5% 1/4W
R022	R92-1034-05	RES. METAL FILM 47M 5% 1/2W
R023	R92-1166-05	RES. METAL FILM 6.2M 5% 1W
R024	R92-0800-05	RES. METAL FILM 10M 5% 1W
R029	RN14BK2C1003P	RES. METAL FILM 100K 1% 1/6W
R030	R92-1125-05	RES. METAL FILM 7.5M 1% 1W

REF. NO	PARTS NO	NAME & DESCRIPTION
R031	R92-1125-05	RES. METAL FILM 7.5M 1% 1W
R035	RD14BB2C104J	RES. CARBON 100K 5% 1/6W
R036	NO USE	
R037	RD14BB2C102J	RES. CARBON 1K 5% 1/6W
R038	RD14BB2C562J	RES. CARBON 5.6K 5% 1/6W
R039	RD14BB2C331J	RES. CARBON 330 5% 1/6W
R040	RD14BB2C563J	RES. CARBON 56K 5% 1/6W
R041	RD14BB2C563J	RES. CARBON 56K 5% 1/6W
R042	RD14BB2C333J	RES. CARBON 33K 5% 1/6W
R043	RD14BB2C273J	RES. CARBON 27K 5% 1/6W
R044	RD14BB2C104J	RES. CARBON 100K 5% 1/6W

U001	NJH4558D	IC, OP AMP
VR001	R12-5525-05	RES. SEMI FIXED 100K B

## VERTICAL UNIT

### X73-1710-00

REF. NO	PARTS NO	NAME & DESCRIPTION
E23-0015-04	EARTH LUG	
E31-2170-05	JUMPING WIRE	
E33-4108-00	WIRE ASSY	
F01-0857-05	HEAT SINK	
F10-1588-04	SHIELD PLATE	
F10-1589-04	SHIELD PLATE	
F10-1590-14	SHIELD PLATE	
J12-0504-05	SPRING PIPE	
J25-5151-12	PCB (UNMOUNTED)	
N30-3008-41	SCREW, PAN HD M 3X8	
Q02-0001-05	BRAIDED WIRE	
Z12-3013-05	TUBE (PLASTIC)	
C001	C91-0501-05	CAP. METAL FILM 0.047 10% 630V
C002	NO USE	
C003	CC45CH1H070D	CAP. CERAMIC 7P 0.5P 50V
C004	CK45F1H103Z	CAP. CERAMIC 0.01 50V
C005	C91-0502-05	CAP. METAL FILM 0.01 20% 630V
C006	CQ92FM1H102K	CAP. MYLAR 1000P 10% 50V
C007	CE04W1E220M	CAP. ELECTRO 22 20% 25V
C008	C91-0501-05	CAP. METAL FILM 0.047 10% 630V
C009	NO USE	
C010	CK45F1H103Z	CAP. CERAMIC 0.01 50V
C011	CC45CH1H070D	CAP. CERAMIC 7P 0.5P 50V
C012	C91-0502-05	CAP. METAL FILM 0.01 20% 630V
C013	CQ92FM1H102K	CAP. MYLAR 1000P 10% 50V
C014	CE04W1E220M	CAP. ELECTRO 22 20% 25V
C015	NO USE	
C016	CC45CH1H030C	CAP. CERAMIC 3P 0.25P 50V
C017	NO USE	
C018	CC45FCH1H070D	CAP. CERAMIC 7P 0.5P 50V
C019	CC45FCH1H070D	CAP. CERAMIC 7P 0.5P 50V
C020	CC45SL1H561J	CAP. CERAMIC 560P 5% 50V
C021	NO USE	
C022	CC45CH1H010C	CAP. CERAMIC 1P 0.25P 50V
C023	NO USE	
C024	CC45FCH1H070D	CAP. CERAMIC 7P 0.5P 50V
C025	CC45FCH1H070D	CAP. CERAMIC 7P 0.5P 50V
C026	CC45SL1H561J	CAP. CERAMIC 560P 5% 50V
C027	NO USE	
C028	CC45CH1H680J	CAP. CERAMIC 68P 5% 50V
C029	CC45CH1H030C	CAP. CERAMIC 3P 0.25P 50V
C030	CK45F1H103Z	CAP. CERAMIC 0.01 50V
C036	CC45CH1H680J	CAP. CERAMIC 68P 5% 50V
C037	CC45CH1H030C	CAP. CERAMIC 3P 0.25P 50V
C038		

# PARTS LIST

REF. NO	PARTS NO	NAME & DESCRIPTION			
C053	CE04W1C221M	CAP. ELECTRO	220	20%	16V
C054	CC45CH1H100D	CAP. CERAMIC	10P	0.5P	50V
C055	CE04W1C471M	CAP. ELECTRO	470	20%	16V
C056	CK45F1H103Z	CAP. CERAMIC	0.01		50V
C057	CE04W1C471M	CAP. ELECTRO	470	20%	16V
C058	CK45F1H103Z	CAP. CERAMIC	0.01		50V
C059	CE04W2A470M	CAP. ELECTRO	47	20%	100V
C060	CK45B2H472K	CAP. CERAMIC	4700P	10%	500V
C061	CE04W1A221M	CAP. ELECTRO	220	20%	10V
C062	CK45F1H103Z	CAP. CERAMIC	0.01		50V
C063	CK45F1H103Z	CAP. CERAMIC	0.01		50V
C064	CK45F1H103Z	CAP. CERAMIC	0.01		50V
C065	CK45F1H103Z	CAP. CERAMIC	0.01		50V
C066	CK45F1H103Z	CAP. CERAMIC	0.01		50V
C067	CK45F1H103Z	CAP. CERAMIC	0.01		50V
C068	CK45F1H103Z	CAP. CERAMIC	0.01		50V
C069	CQ92FM1H104K	CAP. MYLAR	0.1	10%	50V
C070	CQ92FM1H104K	CAP. MYLAR	0.1	10%	50V
C071	CK45F1H103Z	CAP. CERAMIC	0.01		50V
C072	CK45F1H103Z	CAP. CERAMIC	0.01		50V
C073	CQ92FM1H104K	CAP. MYLAR	0.1	10%	50V
C074	CK45F1H103Z	CAP. CERAMIC	0.01		50V
C075	CK45F1H103Z	CAP. CERAMIC	0.01		50V
C076	CK45F1H103Z	CAP. CERAMIC	0.01		50V
C077	CK45F1H103Z	CAP. CERAMIC	0.01		50V
C078	C91-0769-05	CAP. CERAMIC	3P	0.25P	3KV
C079	CC45CH1H050C	CAP. CERAMIC	5P	0.25P	50V
C080	CC45CH1H050C	CAP. CERAMIC	5P	0.25P	50V
C081	CC45CH1H050C	CAP. CERAMIC	5P	0.25P	50V
C082	CC45CH1H050C	CAP. CERAMIC	5P	0.25P	50V
C083	CK45F1H103Z	CAP. CERAMIC	0.01		50V
C084	CK45F1H103Z	CAP. CERAMIC	0.01		50V
C085	NO USE				
C086	C91-1232-05	CAP. CERAMIC	3P	0.25P	3KV
C087	CQ92FM1H332K	CAP. MYLAR	3300P	10%	50V
C088	NO USE				
C089	CQ92FM1H332K	CAP. MYLAR	3300P	10%	50V
C090	NO USE				
C091	CC45CH1H470J	CAP. CERAMIC	47P		50V
C092	CC45CH1H050C	CAP. CERAMIC	5P	0.25P	50V
C093	CC45CH1H020C	CAP. CERAMIC	2P	0.25P	50V
C094	NO USE				
C095	CK45F1H103Z	CAP. CERAMIC	0.01		50V
C096	CE04FW1E330M	CAP. ELECTRO	33	20%	25V
C097	CE04FW1E330M	CAP. ELECTRO	33	20%	25V
C098	CE04FW1E330M	CAP. ELECTRO	33	20%	25V
C099	CE04FW1E330M	CAP. ELECTRO	33	20%	25V
C100	CE04FW1E330M	CAP. ELECTRO	33	20%	25V
C101	CE04FW1E330M	CAP. ELECTRO	33	20%	25V
C102	CE04FW1E330M	CAP. ELECTRO	33	20%	25V
C103	CE04FW1E330M	CAP. ELECTRO	33	20%	25V
C104	CE04FW1E330M	CAP. ELECTRO	33	20%	25V
C105	CE04FW1E330M	CAP. ELECTRO	33	20%	25V
C106	CE04FW1E330M	CAP. ELECTRO	33	20%	25V
C107	NO USE				
C108	CE04FW1E330M	CAP. ELECTRO	33	20%	25V
C109	CC45CH1H200J	CAP. CERAMIC	20P	5%	50V
C110	CC45CH1H270J	CAP. CERAMIC	27P	5%	50V
C111	CC45CH1H200J	CAP. CERAMIC	20P	5%	50V
C112	CQ92FM1H103K	CAP. MYLAR	0.01	10%	50V
C113	CQ92FM1H103K	CAP. MYLAR	0.01	10%	50V
C114	CE04FW1E330M	CAP. ELECTRO	33	20%	25V
C115	CQ92FM1H103K	CAP. MYLAR	0.01	10%	50V
C116	CE04W0J472M	CAP. ELECTRO	4700	20%	6.3V
C117	CE04W0J472M	CAP. ELECTRO	4700	20%	6.3V
C118	CE04FW1E330M	CAP. ELECTRO	33	20%	25V
C119	CC45CH1H070D	CAP. CERAMIC	7P	0.5P	50V
C120	CC45SL1H391J	CAP. CERAMIC	390P	5%	50V
C121	CC45CH1H070D	CAP. CERAMIC	7P	0.5P	50V
C122	CC45CH1H101J	CAP. CERAMIC	100P	5%	50V
C123	CC45CH1H030C	CAP. CERAMIC	3P	0.25P	50V
D001	1S1544A	DIODE			
D002	1SS132	DIODE			
D003	1S1544A	DIODE			
D004	1SS132	DIODE			
D010	1SS132	DIODE			
D011	1SS132	DIODE			
D016	1SS132	DIODE			
D017	1SS132	DIODE			
D018	1SS132	DIODE			
D019	1SS132	DIODE			
D020	1SS132	DIODE			

REF. NO	PARTS NO	NAME & DESCRIPTION		
D021	1SS132	DIODE		
D022	1SS132	DIODE		
D023	1SS132	DIODE		
J028	E31-2746-05	LEAD WIRE WITH CONNECTOR		
J029	E31-2747-05	LEAD WIRE WITH CONNECTOR		
L001	L40-2282-70	FERRI INDUCTOR	10UH	
L002	L40-2282-70	FERRI INDUCTOR	10UH	
L003	L40-1092-70	FERRI INDUCTOR	10UH	
L004	L40-1092-70	FERRI INDUCTOR	10UH	
L005	L40-1001-70	FERRI INDUCTOR	10UH	
L006	L40-1001-70	FERRI INDUCTOR	10UH	
L007	L40-1001-13	FERRI INDUCTOR	10UH	
L008	L40-1001-13	FERRI INDUCTOR	10UH	
L009	L40-1001-70	FERRI INDUCTOR	10UH	
P003	E40-0374-05	PIN CONNECTOR	3 P	
P010	E40-0273-05	PIN CONNECTOR	2 P	
P011	NO USE			
P012	E40-0473-05	PIN CONNECTOR	4 P	
P013	E40-1173-05	PIN CONNECTOR	11 P	
P017	E40-0273-05	PIN CONNECTOR	2 P	
P028	E40-0373-05	PIN CONNECTOR	3 P	
P029	E40-0573-05	PIN CONNECTOR	5 P	
P042	E40-0312-05	PIN CONNECTOR	2 P	
Q001	2SK117(Y)	FET, P-CHANNEL		
Q002	2SK304(F)	FET, N-CHANNEL		
Q003	2SC3354(S,T)	TR. SI, NPN		
Q004	2SK117(Y)	FET, P-CHANNEL		
Q005	2SK304(F)	FET, N-CHANNEL		
Q006	2SC3354(S,T)	TR. SI, NPN		
Q007	2SA1005(K)	TR. SI, PNP		
Q008	2SA1005(K)	TR. SI, PNP		
Q009	2SC3354(S,T)	TR. SI, NPN		
Q010	2SC3354(S,T)	TR. SI, NPN		
Q011	2SC3354(S,T)	TR. SI, NPN		
Q012	2SC3354(S,T)	TR. SI, NPN		
Q013	2SC3354(S,T)	TR. SI, NPN		
Q014	2SC3354(S,T)	TR. SI, NPN		
Q015	2SA1005(K)	TR. SI, PNP		
Q016	2SA1005(K)	TR. SI, PNP		
Q017	2SA1005(K)	TR. SI, PNP		
Q018	2SA1005(K)	TR. SI, PNP		
Q019	2SC3354(S,T)	TR. SI, NPN		
Q020	2SC3354(S,T)	TR. SI, NPN		
Q021	2SC3354(S,T)	TR. SI, NPN		
Q022	2SC3354(S,T)	TR. SI, NPN		
Q023	2SC3354(S,T)	TR. SI, NPN		
Q024	2SC3354(S,T)	TR. SI, NPN		
Q025	2SC2785(F)	TR. SI, NPN		
Q026	2SA1005(K)	TR. SI, PNP		
Q027	2SA1005(K)	TR. SI, PNP		
Q028	2SA1206	TR. SI, PNP		
Q029	2SA1206	TR. SI, PNP		
Q030	2SA1206	TR. SI, PNP		
Q031	2SA1206	TR. SI, PNP		
Q032	2SC3354(S,T)	TR. SI, NPN		
Q033	2SC3354(S,T)	TR. SI, NPN		
Q034	2SC3354(S,T)	TR. SI, NPN		
Q035	2SC3354(S,T)	TR. SI, NPN		
Q036	2SC3354(S,T)	TR. SI, NPN		
Q037	2SC3354(S,T)	TR. SI, NPN		
Q038	2SC3354(S,T)	TR. SI, NPN		
Q039	2SC3354(S,T)	TR. SI, NPN		
Q040	2SC3779(D)	TR. SI, NPN		
Q041	NO USE			
Q042	2SC3779(D)	TR. SI, NPN		
Q043	NO USE			
Q044	2SC3596(E)	TR. SI, NPN		
Q045	2SC3596(E)	TR. SI, NPN		
Q046	2SA1005(K)	TR. SI, PNP		
Q047	2SC3354(S,T)	TR. SI, NPN		
Q051	2SC2786(K)	TR. SI, NPN		
Q052	2SC2786(K)	TR. SI, NPN		
Q053	2SC2786(K)	TR. SI, NPN		
Q054	2SC2786(K)	TR. SI, NPN		
Q055	2SA1005(K)	TR. SI, PNP		
Q056	2SC2786(K)	TR. SI, NPN		

# PARTS LIST

REF.NO	PARTS NO	NAME & DESCRIPTION	TR.	SI.	NPN
Q057	2SC2785(F)	TR. SI, NPN			
Q058	2SC2785(F)	TR. SI, NPN			
Q059	2SC2785(F)	TR. SI, NPN			
Q060	2SC2785(F)	TR. SI, NPN			
Q061	2SC2785(F)	TR. SI, NPN			
Q062	2SC2785(F)	TR. SI, NPN			
Q063	2SK304(F)	FET, N-CHANNEL			
Q064	2SK304(F)	FET, N-CHANNEL			
R001	RD14BB2E105J	RES. CARBON 1M 5% 1/4W			
R002	RD14BB2C220J	RES. CARBON 22 5% 1/6W			
R003	RD14BB2E100J	RES. CARBON 10 5% 1/4W			
R004	RN14BK2C5003F	RES. METAL FILM 500K 1% 1/6W			
R005	RN14BK2C5003F	RES. METAL FILM 500K 1% 1/6W			
R006	RD14BB2C105J	RES. CARBON 1M 5% 1/6W			
R007	RD14BB2C162J	RES. CARBON 1.6K 5% 1/6W			
R008	RD14BB2C102J	RES. CARBON 1K 5% 1/6W			
R009	RD14BB2C100J	RES. CARBON 10 5% 1/6W			
R010	RD14BB2C103J	RES. CARBON 10K 5% 1/6W			
R011	RD14BB2C470J	RES. CARBON 47 5% 1/6W			
R012	RD14BB2C684J	RES. CARBON 680K 5% 1/6W			
R013	RD14BB2C181J	RES. CARBON 180 5% 1/6W			
R014	RD14BB2C331J	RES. CARBON 330 5% 1/6W			
R015	RD14BB2C100J	RES. CARBON 10 5% 1/6W			
R016	RD14BB2C100J	RES. CARBON 10 5% 1/6W			
R017	RD14BB2C751J	RES. CARBON 750 5% 1/6W			
R018	RD14BB2E105J	RES. CARBON 1M 5% 1/4W			
R019	RD14BB2C220J	RES. CARBON 22 5% 1/6W			
R020	RD14BB2E100J	RES. CARBON 10 5% 1/4W			
R021	RN14BK2C5003F	RES. METAL FILM 500K 1% 1/6W			
R022	RN14BK2C5003F	RES. METAL FILM 500K 1% 1/6W			
R023	RD14BB2E105J	RES. CARBON 1M 5% 1/4W			
R024	RD14BB2C162J	RES. CARBON 1.6K 5% 1/6W			
R025	RD14BB2C102J	RES. CARBON 1K 5% 1/6W			
R026	RD14BB2C103J	RES. CARBON 10K 5% 1/6W			
R027	RD14BB2C470J	RES. CARBON 47 5% 1/6W			
R028	RD14BB2C684J	RES. CARBON 680K 5% 1/6W			
R029	RD14BB2C181J	RES. CARBON 180 5% 1/6W			
R030	RD14BB2C331J	RES. CARBON 330 5% 1/6W			
R031	RD14BB2C100J	RES. CARBON 10 5% 1/6W			
R032	RD14BB2C100J	RES. CARBON 10 5% 1/6W			
R033	RD14BB2C751J	RES. CARBON 750 5% 1/6W			
R034	RD14BB2E150J	RES. CARBON 15 5% 1/4W			
R035	RD14BB2C180J	RES. CARBON 18 5% 1/6W			
R036	RD14BB2C200J	RES. CARBON 20 5% 1/6W			
R037	RD14BB2C121J	RES. CARBON 120 5% 1/6W			
R038	RD14BB2C182J	RES. CARBON 1.8K 5% 1/6W			
R039	RN14BK2C3001F	RES. METAL FILM 3K 1% 1/6W			
R040	RN14BK2C3001F	RES. METAL FILM 3K 1% 1/6W			
R041	RN14BK2C2200F	RES. METAL FILM 220 1% 1/6W			
R042	RD14BB2C163J	RES. CARBON 16K 5% 1/6W			
R043	RD14BB2C220J	RES. CARBON 22 5% 1/6W			
R044	RD14BB2C470J	RES. CARBON 47 5% 1/6W			
R045	RD14BB2C680J	RES. CARBON 68 5% 1/6W			
R046	RD14BB2C104J	RES. CARBON 100K 5% 1/6W			
R047	RN14BK2E2401F	RES. METAL FILM 2.4K 1% 1/4W			
R048	RN14BK2C2401F	RES. METAL FILM 2.4K 1% 1/6W			
R049	RD14BB2C241J	RES. CARBON 240 5% 1/6W			
R050	RD14BB2E220J	RES. CARBON 22 5% 1/4W			
R051	RD14BB2E220J	RES. CARBON 22 5% 1/4W			
R052	RN14BK2C1201F	RES. METAL FILM 1.2K 1% 1/6W			
R053	RN14BK2C1201F	RES. METAL FILM 1.2K 1% 1/6W			
R054	RN14BK2C2000F	RES. METAL FILM 200 1% 1/6W			
R055	RD14BB2C303J	RES. CARBON 30K 5% 1/6W			
R056	RN14BK2C6800F	RES. METAL FILM 680 1% 1/6W			
R057	RN14BK2C2401F	RES. METAL FILM 2.4K 1% 1/6W			
R058	RN14BK2C4701F	RES. METAL FILM 4.7K 1% 1/6W			
R059	RN14BK2C7500F	RES. METAL FILM 750 1% 1/6W			
R060	RN14BK2C7500F	RES. METAL FILM 750 1% 1/6W			
R061	RD14BB2E101J	RES. CARBON 100 5% 1/4W			
R062	RD14BB2E101J	RES. CARBON 100 5% 1/4W			
R063	RD14BB2E150J	RES. CARBON 15 5% 1/4W			
R064	RD14BB2C180J	RES. CARBON 18 5% 1/6W			
R065	RD14BB2C200J	RES. CARBON 20 5% 1/6W			
R066	RD14BB2C121J	RES. CARBON 120 5% 1/6W			
R067	RD14BB2C182J	RES. CARBON 1.8K 5% 1/6W			
R068	RN14BK2C3001F	RES. METAL FILM 3K 1% 1/6W			
R069	RN14BK2C3001F	RES. METAL FILM 3K 1% 1/6W			
R070	RN14BK2C2200F	RES. METAL FILM 220 1% 1/6W			
R071	RD14BB2C163J	RES. CARBON 16K 5% 1/6W			
R072	RD14BB2C220J	RES. CARBON 22 5% 1/6W			
R073	RD14BB2C470J	RES. CARBON 47 5% 1/6W			
R074	RD14BB2C680J	RES. CARBON 68 5% 1/6W			
R075	RD14BB2C104J	RES. CARBON 100K 5% 1/6W			
R076	RN14BK2E2401F	RES. METAL FILM 2.4K 1% 1/4W			

REF.NO	PARTS NO	NAME & DESCRIPTION	TR.	SI.	NPN
R077	RN14BK2E2401F	RES. METAL FILM 2.4K 1% 1/4W			
R078	RD14BB2C241J	RES. CARBON 240 5% 1/6W			
R079	RD14BB2C220J	RES. CARBON 22 5% 1/6W			
R080	RD14BB2C220J	RES. CARBON 22 5% 1/6W			
R081	RD14BB2C112J	RES. CARBON 1.1K 5% 1/6W			
R082	RD14BB2C112J	RES. CARBON 1.1K 5% 1/6W			
R083	RD14BB2C151J	RES. CARBON 150 5% 1/6W			
R084	RD14BB2C303J	RES. CARBON 30K 5% 1/6W			
R085	RN14BK2C6800F	RES. METAL FILM 680 1% 1/6W			
R086	RN14BK2C2401F	RES. METAL FILM 2.4K 1% 1/6W			
R087	RN14BK2C4701F	RES. METAL FILM 4.7K 1% 1/6W			
R088	NO USE				
R089	RN14BK2C7500F	RES. METAL FILM 750 1% 1/6W			
R090	RN14BK2C7500F	RES. METAL FILM 750 1% 1/6W			
R091	RD14BB2C101J	RES. CARBON 100 5% 1/6W			
R092	RD14BB2C101J	RES. CARBON 100 5% 1/6W			
R093	RD14BB2E470J	RES. CARBON 47 5% 1/4W			
R094	RD14BB2E470J	RES. CARBON 47 5% 1/4W			
R095	RN14BK2E6201F	RES. METAL FILM 6.2K 1% 1/4W			
R096	RN14BK2C3901F	RES. METAL FILM 3.9K 1% 1/6W			
R097	RN14BK2E1001F	RES. METAL FILM 1K 1% 1/4W			
R098	RN14BK2C1001F	RES. METAL FILM 1K 1% 1/6W			
R099	RN14BK2C6800F	RES. METAL FILM 680 1% 1/6W			
R100	RN14BK2C6800F	RES. METAL FILM 680 1% 1/6W			
R101	RD14BB2C470J	RES. CARBON 47 5% 1/6W			
R102	RD14BB2C470J	RES. CARBON 47 5% 1/6W			
R103	RD14BB2C821J	RES. CARBON 820 5% 1/6W			
R104	RD14BB2C821J	RES. CARBON 820 5% 1/6W			
R105	RN14BK2C3300F	RES. METAL FILM 330 1% 1/6W			
R106	RD14BB2C273J	RES. CARBON 27K 5% 1/6W			
R107	RD14BB2C101J	RES. CARBON 100 5% 1/6W			
R108	RD14BB2C101J	RES. CARBON 100 5% 1/6W			
R109	RD14BB2C182J	RES. CARBON 1.8K 5% 1/6W			
R110	RN14BK2C2001F	RES. METAL FILM 2K 1% 1/6W			
R111	RN14BK2C3000F	RES. METAL FILM 300 1% 1/6W			
R112	RD14BB2C432J	RES. CARBON 4.3K 5% 1/6W			
R113	RD14BB2C101J	RES. CARBON 100 5% 1/6W			
R114	RD14BB2C101J	RES. CARBON 100 5% 1/6W			
R115	RN14BK2C2001F	RES. METAL FILM 2K 1% 1/6W			
R116	RN14BK2C2001F	RES. METAL FILM 2K 1% 1/6W			
R117	RD14BB2C470J	RES. CARBON 47 5% 1/6W			
R118	RD14BB2C470J	RES. CARBON 47 5% 1/6W			
R119	RN14BK2C7501F	RES. METAL FILM 7.5K 1% 1/6W			
R120	RN14BK2C2401F	RES. METAL FILM 2.4K 1% 1/6W			
R121	RD14BB2C470J	RES. CARBON 47 5% 1/6W			
R122	RD14BB2C470J	RES. CARBON 47 5% 1/6W			
R123	RN14BK2C6201F	RES. METAL FILM 6.2K 1% 1/6W			
R124	RN14BK2C3901F	RES. METAL FILM 3.9K 1% 1/6W			
R125	RD14BB2C470J	RES. CARBON 47 5% 1/6W			
R126	RD14BB2C470J	RES. CARBON 47 5% 1/6W			
R127	RN14BK2C6201F	RES. METAL FILM 6.2K 1% 1/6W			
R128	RN14BK2C3901F	RES. METAL FILM 3.9K 1% 1/6W			
R129	RD14BB2C103J	RES. CARBON 10K 5% 1/6W			
R130	RN14BK2E1001F	RES. METAL FILM 1K 1% 1/4W			
R131	RN14BK2E1001F	RES. METAL FILM 1K 1% 1/4W			
R132	RN14BK2C6800F	RES. METAL FILM 680 1% 1/6W			
R133	RN14BK2C6800F	RES. METAL FILM 680 1% 1/6W			
R134	RD14BB2E470J	RES. CARBON 47 5% 1/4W			
R135	RD14BB2E470J	RES. CARBON 47 5% 1/4W			
R136	RD14BB2C821J	RES. CARBON 820 5% 1/6W			
R137	RD14BB2C821J	RES. CARBON 820 5% 1/6W			
R138	RN14BK2C3300F	RES. METAL FILM 330 1% 1/6W			
R139	RD14BB2C273J	RES. CARBON 27K 5% 1/6W			
R140	RD14BB2C101J	RES. CARBON 100 5% 1/6W			
R141	RD14BB2C101J	RES. CARBON 100 5% 1/6W			
R142	RN14BK2C2001F	RES. METAL FILM 2K 1% 1/6W			
R143	RN14BK2C2001F	RES. METAL FILM 2K 1% 1/6W			
R144	RN14BK2C2200F	RES. METAL FILM 220 1% 1/6W			
R145	RD14BB2C432J	RES. CARBON 4.3K 5% 1/6W			
R146	RD14BB2C101J	RES. CARBON 100 5% 1/6W			
R147	RD14BB2C101J	RES. CARBON 100 5% 1/6W			
R148	RN14BK2C2001F	RES. METAL FILM 2K 1% 1/6W			
R149	RN14BK2C2001F	RES. METAL FILM 2K 1% 1/6W			
R150	RD14BB2C470J	RES. CARBON 47 5% 1/6W			
R151	RD14BB2C470J	RES. CARBON 47 5% 1/6W			
R152	RN14BK2C7501F	RES. METAL FILM 7.5K 1% 1/6W			
R153	RN14BK2C2401F	RES. METAL FILM 2.4K 1% 1/6W			
R156	RN14BK2C5100F	RES. METAL FILM 510 1% 1/6W			
R157	RN14BK2C5100F	RES. METAL FILM 510 1% 1/6W			
R158	RN14BK2C2400F	RES. METAL FILM 240 1% 1/6W			
R159	RN14BK2C2701F	RES. METAL FILM 2.7K 1% 1/6W			
R160	NO USE				
R161	RD14BB2C470J	RES. CARBON 47 5% 1/6W			
R162	RD14BB2C470J	RES. CARBON 47 5% 1/6W			



# PARTS LIST

REF. NO	PARTS NO	NAME & DESCRIPTION	REF. NO	PARTS NO	NAME & DESCRIPTION
R163	RD14BB2C122J	RES. CARBON 1.2K 5% 1/6W	R251	RD14BB2C561J	RES. CARBON 560 5% 1/6W
R164	RD14BB2C122J	RES. CARBON 1.2K 5% 1/6W	R252	RD14BB2C391J	RES. CARBON 390 5% 1/6W
R165	RD14BB2C470J	RES. CARBON 47 5% 1/6W	R253	RD14BB2C391J	RES. CARBON 390 5% 1/6W
R166	RD14BB2C470J	RES. CARBON 47 5% 1/6W	R254	RD14BB2C752J	RES. CARBON 7.5K 5% 1/6W
R167	RN14BK2C6800F	RES. METAL FILM 680 1% 1/6W	R255	RD14BB2E242J	RES. CARBON 2.4K 5% 1/4W
R168	RN14BK2C6800F	RES. METAL FILM 680 1% 1/6W	R256	RD14BB2C821J	RES. CARBON 820 5% 1/6W
R169	RN14BK2C3900F	RES. METAL FILM 390 1% 1/6W	R257	RD14BB2E101J	RES. CARBON 100 5% 1/4W
R170	RD14BB2C104J	RES. CARBON 100K 5% 1/6W	R258	RD14BB2C332J	RES. CARBON 3.3K 5% 1/6W
R171	RN14BK2C1800F	RES. METAL FILM 180 1% 1/6W	R259	NO USE	
R172	RN14BK2C91R0F	RES. METAL FILM 91.0 1% 1/6W	R260	RD14BB2C222J	RES. CARBON 2.2K 5% 1/6W
R173	RN14BK2C91R0F	RES. METAL FILM 91.0 1% 1/6W	R261	RD14BB2E470J	RES. CARBON 47 5% 1/4W
R174	RD14BB2C220J	RES. CARBON 22 5% 1/6W	R262	RD14BB2C100J	RES. CARBON 10 5% 1/6W
R175	RD14BB2C220J	RES. CARBON 22 5% 1/6W	R263	RD14BB2E221J	RES. CARBON 220 5% 1/4W
R176	RD14BB2C103J	RES. CARBON 10K 5% 1/6W	R264	RD14BB2E221J	RES. CARBON 220 5% 1/4W
R177	RD14BB2C103J	RES. CARBON 10K 5% 1/6W	R265	RD14BB2C101J	RES. CARBON 100 5% 1/6W
R178	RN14BK2C8200F	RES. METAL FILM 820 1% 1/6W	R266	RD14BB2C220J	RES. CARBON 22 5% 1/6W
R179	RN14BK2C8200F	RES. METAL FILM 820 1% 1/6W	R267	RD14BB2C244J	RES. CARBON 240K 5% 1/6W
R180	RD14BB2C392J	RES. CARBON 3.9K 5% 1/6W	R268	RD14BB2C244J	RES. CARBON 240K 5% 1/6W
R181	RD14BB2C392J	RES. CARBON 3.9K 5% 1/6W	R269	RD14BB2C102J	RES. CARBON 1K 5% 1/6W
R182	RD14BB2C152J	RES. CARBON 1.5K 5% 1/6W	R270	RD14BB2C102J	RES. CARBON 1K 5% 1/6W
R183	RD14BB2C152J	RES. CARBON 1.5K 5% 1/6W	R271	RD14BB2C122J	RES. CARBON 1.2K 5% 1/6W
R184	RD14BB2C470J	RES. CARBON 47 5% 1/6W	R274	RD14BB2C183J	RES. CARBON 18K 5% 1/6W
R185	RD14BB2C470J	RES. CARBON 47 5% 1/6W	R275	RD14BB2C182J	RES. CARBON 1.8K 5% 1/6W
R186	RN14BK2C4700F	RES. METAL FILM 470 1% 1/6W	R276	RD14BB2C182J	RES. CARBON 1.8K 5% 1/6W
R187	RN14BK2C4700F	RES. METAL FILM 470 1% 1/6W	R277	RD14BB2C222J	RES. CARBON 2.2K 5% 1/6W
R188	RN14BK2C4300F	RES. METAL FILM 430 1% 1/6W	R278	RD14BB2C102J	RES. CARBON 1K 5% 1/6W
R189	RD14BB2C752J	RES. CARBON 7.5K 5% 1/6W	R279	RD14BB2C102J	RES. CARBON 1K 5% 1/6W
R190	RD14BB2C220J	RES. CARBON 22 5% 1/6W	R280	RD14BB2C472J	RES. CARBON 4.7K 5% 1/6W
R191	RD14BB2C220J	RES. CARBON 22 5% 1/6W	R281	RN14BK2C3001F	RES. METAL FILM 3K 1% 1/6W
R192	RD14BB2C470J	RES. CARBON 47 5% 1/6W	R282	RD14BB2C101J	RES. CARBON 100 5% 1/6W
R193	RD14BB2C470J	RES. CARBON 47 5% 1/6W	R283	RD14BB2C101J	RES. CARBON 100 5% 1/6W
R194	RN14BK2C3001F	RES. METAL FILM 3K 1% 1/6W	R284	RD14BB2C101J	RES. CARBON 100 5% 1/6W
R195	RN14BK2C7500F	RES. METAL FILM 750 1% 1/6W	R285	RD14BB2C101J	RES. CARBON 100 5% 1/6W
R196	RN14BK2C7500F	RES. METAL FILM 750 1% 1/6W	R286	NO USE	
R197	RD14BB2E220J	RES. CARBON 22 5% 1/4W	R287	RD14BB2C120J	RES. CARBON 12 5% 1/6W
R198	RD14BB2E220J	RES. CARBON 22 5% 1/4W	R288	RD14BB2C120J	RES. CARBON 12 5% 1/6W
R199	RD14BB2C332J	RES. CARBON 3.3K 5% 1/6W	R289	RD14BB2C202J	RES. CARBON 2K 5% 1/6W
R200	RD14BB2C332J	RES. CARBON 3.3K 5% 1/6W	R290	RD14BB2C220J	RES. CARBON 22 5% 1/6W
R201	RD14BB2E470J	RES. CARBON 47 5% 1/4W	R291	RD14BB2C220J	RES. CARBON 22 5% 1/6W
R202	NO USE		R292	RD14BB2C100J	RES. CARBON 10 5% 1/6W
R203	RD14BB2E470J	RES. CARBON 47 5% 1/4W	R293	RD14BB2C220J	RES. CARBON 22 5% 1/6W
R204	NO USE		R294	RD14BB2C332J	RES. CARBON 3.3K 5% 1/6W
R205	RN14BK2E82R0F	RES. METAL FILM 82.0 1% 1/4W	R295	RD14BB2C332J	RES. CARBON 3.3K 5% 1/6W
R206	RN14BK2E82R0F	RES. METAL FILM 82.0 1% 1/4W	R296	RD14BB2C223J	RES. CARBON 22K 5% 1/6W
R207	RN14BK2E5100F	RES. METAL FILM 510 1% 1/4W	R297	RD14BB2C681J	RES. CARBON 680 5% 1/6W
R208	RD14BB2C153J	RES. CARBON 15K 5% 1/6W	R298	RD14BB2C681J	RES. CARBON 680 5% 1/6W
R209	RD14BB2C220J	RES. CARBON 22 5% 1/6W	S001	S32-4007-05	LEVER SWITCH
R210	RD14BB2C220J	RES. CARBON 22 5% 1/6W	S002	S32-4007-05	LEVER SWITCH
R211	RD14BB2E470J	RES. CARBON 47 5% 1/4W	S003	S33-2501-05	LEVER SWITCH
R212	RD14BB2E470J	RES. CARBON 47 5% 1/4W	S004	S02-4504-25	ROTARY SWITCH
R213	RN14BK2C1503F	RES. METAL FILM 150K 1% 1/6W	S005	S02-4504-25	ROTARY SWITCH
R214	RN14BK2C1503F	RES. METAL FILM 150K 1% 1/6W	S006	R01-1513-05	V.R. 2K B
R215	RD14BB2C471J	RES. CARBON 470 5% 1/6W	TC002	C05-0444-05	CAP. TRIMMER 10P
R216	RD14BB2C471J	RES. CARBON 470 5% 1/6W	TC003	C05-0444-05	CAP. TRIMMER 10P
R217	RS14AB3Y621J	RES. METAL FILM 620 5% 7W	TC004	NO USE	
R218	RS14AB3Y621J	RES. METAL FILM 620 5% 7W	TC005	C05-0444-05	CAP. TRIMMER 10P
R219	RD14BB2C102J	RES. CARBON 1K 5% 1/6W	TC006	C05-0444-05	CAP. TRIMMER 10P
R220	RD14BB2C102J	RES. CARBON 1K 5% 1/6W	TC007	C05-0444-05	CAP. TRIMMER 10P
R221	RN14BK2C2002F	RES. METAL FILM 20K 1% 1/6W	TC008	NO USE	
R222	RD14BB2E153J	RES. CARBON 15K 5% 1/4W	TC009	C05-0444-05	CAP. TRIMMER 10P
R223	RD14BB2C102J	RES. CARBON 1K 5% 1/6W	TC010	NO USE	
R224	RN14BK2C3601F	RES. METAL FILM 3.6K 1% 1/6W	TC011	C05-0444-05	CAP. TRIMMER 10P
R225	RN14BK2C1001F	RES. METAL FILM 1K 1% 1/6W	TC012	C05-0444-05	CAP. TRIMMER 10P
R226	RD14BB2C332J	RES. CARBON 3.3K 5% 1/6W	TC013	C05-0444-05	CAP. TRIMMER 10P
R227	RD14BB2C470J	RES. CARBON 47 5% 1/6W	TH003	SDT1000	THERMISTOR
R228	RD14BB2C202J	RES. CARBON 2K 5% 1/6W	TH004	SDT100	THERMISTOR
R229	NO USE		TH005	SDT100	THERMISTOR
R230	RD14BB2C470J	RES. CARBON 47 5% 1/6W	TH006	SDT1000	THERMISTOR
R231	RD14BB2E104J	RES. CARBON 100K 5% 1/4W	TP001	E40-0211-05	PIN CONNECTOR 2 P
R232	RD14BB2E221J	RES. CARBON 220 5% 1/4W	U001	LF411CN	IC, DUAL JFET INPUT OP-AMP
R233	NO USE		U002	LF411CN	IC, DUAL JFET INPUT OP-AMP
R234	RD14BB2C561J	RES. CARBON 560 5% 1/6W	U003	CA3127E	IC. TR, ARRY N-P-N
R237	RD14BB2C103J	RES. CARBON 10K 5% 1/6W	U004	CA3127E	IC. TR, ARRY N-P-N
R238	RD14BB2C103J	RES. CARBON 10K 5% 1/6W	U005	NJM4558D	IC, OP AMP
R239	RD14BB2C103J	RES. CARBON 10K 5% 1/6W	U006	SN74LS00N	IC, QUAD 2-INPUT NAND GATE
R240	RD14BB2C103J	RES. CARBON 10K 5% 1/6W	VR001	R12-4510-05	RES. SEMI FIXED 50K B
R241	RD14BB2C102J	RES. CARBON 1K 5% 1/6W	VR002	R12-0563-05	RES. SEMI FIXED 500 B
R242	RD14BB2C102J	RES. CARBON 1K 5% 1/6W	VR003	R12-4510-05	RES. SEMI FIXED 50K B
R245	RD14BB2E102J	RES. CARBON 1K 5% 1/4W	VR004	R12-0563-05	RES. SEMI FIXED 500 B
R246	RD14BB2E102J	RES. CARBON 1K 5% 1/4W			
R247	RD14BB2C472J	RES. CARBON 4.7K 5% 1/6W			
R248	RD14BB2C472J	RES. CARBON 4.7K 5% 1/6W			
R249	RD14BB2E102J	RES. CARBON 1K 5% 1/4W			
R250	RD14BB2E102J	RES. CARBON 1K 5% 1/4W			

# PARTS LIST

REF. NO	PARTS NO	NAME & DESCRIPTION
VR005	R12-0561-05	RES. SEMI FIXED 100 B
VR006	R12-4510-05	RES. SEMI FIXED 50K B
VR007	R12-0562-05	RES. SEMI FIXED 200 B
VR008	S02-4504-25	ROTARY SWITCH
VR009	S02-4504-25	ROTARY SWITCH
VR010	R12-0563-05	RES. SEMI FIXED 500 B
VR011	R12-0562-05	RES. SEMI FIXED 200 B
VR012	R12-0561-05	RES. SEMI FIXED 100 B
VR013	R12-4510-05	RES. SEMI FIXED 50K B
VR014	R12-0562-05	RES. SEMI FIXED 200 B
VR015	S02-4504-25	ROTARY SWITCH
VR016	S02-4504-25	ROTARY SWITCH
VR017	R12-0561-05	RES. SEMI FIXED 100 B
VR018	R12-0562-05	RES. SEMI FIXED 200 B
VR019	R12-0562-05	RES. SEMI FIXED 200 B
VR020	R12-0563-05	RES. SEMI FIXED 500 B
VR021	R12-0562-05	RES. SEMI FIXED 200 B
VR022	R12-0563-05	RES. SEMI FIXED 500 B
VR023	NO USE	
VR024	R06-1503-05	V.R. 2K B X2
VR025	R12-0563-05	RES. SEMI FIXED 500 B
VR026	R12-0562-05	RES. SEMI FIXED 200 B
VR027	R12-0562-05	RES. SEMI FIXED 200 B
VR028	NO USE	
VR029	R01-1513-05	V.R. 2K B
VR030	R12-2517-05	RES. SEMI FIXED 10K B
VR033	R12-3537-05	RES. SEMI FIXED 20K B

## HORIZONTAL UNIT

### X74-1450-00

REF. NO	PARTS NO	NAME & DESCRIPTION
	B31-2170-05	JUMPING WIRE
	B33-4106-05	WIRE ASSY
	F01-0846-05	HEAT SINK
	J25-5152-02	PCB (UNMOUNTED)
	N30-3008-41	SCREW, PAN HD M 3x8
C001	CE04BW1E220M	CAP. ELECTRO 22 20% 25V
C002	CQ92FM1H102K	CAP. MYLAR 1000P 10% 50V
C003	CC45CH1H470J	CAP. CERAMIC 47P 5% 50V
C007	CK45F1H103Z	CAP. CERAMIC 0.01 50V
C008	CC45CH1H100D	CAP. CERAMIC 10P 0.5P 50V
C009	CE04BW1E220M	CAP. ELECTRO 22 20% 25V
C010	CQ92FM1H104K	CAP. MYLAR 0.1 10% 50V
C011	CE04HW1H010M	CAP. ELECTRO 1 20% 50V
C012	CQ92FM1H102K	CAP. MYLAR 1000P 10% 50V
C013	CQ92FM1H222K	CAP. MYLAR 2200P 10% 50V
C014	CQ92FM1H223K	CAP. MYLAR 0.022 10% 50V
C015	CK45F1H103Z	CAP. CERAMIC 0.01 50V
C016	CQ92FM1H104K	CAP. MYLAR 0.1 10% 50V
C017	CQ92FM1H473K	CAP. MYLAR 0.047 10% 50V
C018	CQ92FM1H103K	CAP. MYLAR 0.01 10% 50V
C019	CC45CH1H020C	CAP. CERAMIC 2P 0.25P 50V
C020	CE04BW1H010M	CAP. ELECTRO 1 20% 50V
C021	CE04HW1H010M	CAP. ELECTRO 1 20% 50V
C022	CK45F1H103Z	CAP. CERAMIC 0.01 50V
C023	CK45B1H102K	CAP. CERAMIC 1000P 10% 50V
C024	CC45FCH1H120J	CAP. CERAMIC 12P 5% 50V
C025	CC45CH1H470J	CAP. CERAMIC 47P 5% 50V
C026	CK45F1H103Z	CAP. CERAMIC 0.01 50V
C027	CQ92FM1H103K	CAP. MYLAR 0.01 10% 50V
C028	CQ92FM1H104K	CAP. MYLAR 0.1 10% 50V
C029	CE04BW1E220M	CAP. ELECTRO 22 20% 25V
C030	CK45F1H103Z	CAP. CERAMIC 0.01 50V
C031	C91-0574-05	CAP. MYLAR 1 5% 100V
C032	C91-0573-05	CAP. MYLAR 0.01 1% 100V
C033	CQ92FM1H102K	CAP. MYLAR 1000P 10% 50V
C034	CM93BD2A900J	CAP. MICA 90P 5% 100V
C035	CK45B2H472K	CAP. CERAMIC 4700P 10% 500V
C038	CK45F1H103Z	CAP. CERAMIC 0.01 50V
C039	CC45SL1H331J	CAP. CERAMIC 330P 5% 50V
C040	CK45F1H103Z	CAP. CERAMIC 0.01 50V
C041	NO USE	
C042	CC45CH1H680J	CAP. CERAMIC 68P 5% 50V
C043	CK45B2H472K	CAP. CERAMIC 4700P 10% 500V
C044	CK45B2H472K	CAP. CERAMIC 4700P 10% 500V
C045	CQ92FM1H104K	CAP. MYLAR 0.1 10% 50V
C046	CQ92FM1H104K	CAP. MYLAR 0.1 10% 50V
C049	CK45B2H472K	CAP. CERAMIC 4700P 10% 500V
C050	CC45CH1H221J	CAP. CERAMIC 220P 5% 50V

REF. NO	PARTS NO	NAME & DESCRIPTION
C051	CQ92FM1H102K	CAP. MYLAR 1000P 10% 50V
C052	CK45F1H103Z	CAP. CERAMIC 0.01 50V
C053	CK45F1H103Z	CAP. CERAMIC 0.01 50V
C054	CE04W1E332M	CAP. ELECTRO 3300 20% 25V
C055	CE04W1A471M	CAP. ELECTRO 470 20% 10V
C056	CK45F1H103Z	CAP. CERAMIC 0.01 50V
C057	CE04W1E332M	CAP. ELECTRO 3300 20% 25V
C058	CK45F1H103Z	CAP. CERAMIC 0.01 50V
C059	CK45F1H103Z	CAP. CERAMIC 0.01 50V
C060	CE04W1C471M	CAP. ELECTRO 470 20% 16V
C061	CK45F1H103Z	CAP. CERAMIC 0.01 50V
C062	CE04W1E332M	CAP. ELECTRO 3300 20% 25V
C063	CE04W1C471M	CAP. ELECTRO 470 20% 16V
C064	CK45F1H103Z	CAP. CERAMIC 0.01 50V
C065	CE04W2A221M	CAP. ELECTRO 220 20% 100V
C066	CE04W2A470M	CAP. ELECTRO 47 20% 100V
C067	CK45B2H472K	CAP. CERAMIC 4700P 10% 500V
C068	CE04W2E470M	CAP. ELECTRO 47 20% 250V
C069	CE04W2E47M	CAP. ELECTRO 4.7 20% 250V
C070	CK45B2H472K	CAP. CERAMIC 4700P 10% 500V
C071	CQ92FM1H103K	CAP. MYLAR 0.01 10% 50V
C072	CE04BW1E220M	CAP. ELECTRO 22 20% 25V
C073	CK45F1H103Z	CAP. CERAMIC 0.01 50V
C074	CK45F1H103Z	CAP. CERAMIC 0.01 50V
C075	CK45F1H103Z	CAP. CERAMIC 0.01 50V
C076	CQ92FM1H104K	CAP. MYLAR 0.1 10% 50V
C077	CQ92FM1H104K	CAP. MYLAR 0.1 10% 50V
C078	CK45F1H103Z	CAP. CERAMIC 0.01 50V
C079	CK45F1H103Z	CAP. CERAMIC 0.01 50V
C080	CK45F1H103Z	CAP. CERAMIC 0.01 50V
C081	CQ92FM1H104K	CAP. MYLAR 0.1 10% 50V
C082	CK45F1H103Z	CAP. CERAMIC 0.01 50V
C083	CQ92FM1H104K	CAP. MYLAR 0.1 10% 50V
C084	CQ92FM1H104K	CAP. MYLAR 0.1 10% 50V
C085	CK45F1H103Z	CAP. CERAMIC 0.01 50V
C086	CC45SL1H471J	CAP. CERAMIC 470P 5% 50V
C087	CK45F1H103Z	CAP. CERAMIC 0.01 50V
C088	CK45F1H103Z	CAP. CERAMIC 0.01 50V
C089	CK45F1H103Z	CAP. CERAMIC 0.01 50V
C090	CK45F1H103Z	CAP. CERAMIC 0.01 50V
C091	CE04FW1A101M	CAP. ELECTRO 100 20% 10V
C092	CQ92FM1H104K	CAP. MYLAR 0.1 10% 50V
C093	CK45F1H103Z	CAP. CERAMIC 0.01 50V
C094	CK45F1H103Z	CAP. CERAMIC 0.01 50V
C095	CK45F1H103Z	CAP. CERAMIC 0.01 50V
C096	CK45F1H103Z	CAP. CERAMIC 0.01 50V
C097	CK45F1H103Z	CAP. CERAMIC 0.01 50V
C098	CK45F1H103Z	CAP. CERAMIC 0.01 50V
C099	CK45F1H103Z	CAP. CERAMIC 0.01 50V
C100	CK45F1H103Z	CAP. CERAMIC 0.01 50V
C101	CC45CH1H680J	CAP. CERAMIC 68P 5% 50V
C102	CC45FCH1H100D	CAP. CERAMIC 10P 0.5P 50V
C103	CC45CH1H470J	CAP. CERAMIC 47P 5% 50V
C104	CK45F1H103Z	CAP. CERAMIC 0.01 50V
C105	CK45F1H103Z	CAP. CERAMIC 0.01 50V
C106	CC45CH1H040C	CAP. CERAMIC 4P 0.25P 50V
C107	CK45F1H103Z	CAP. CERAMIC 0.01 50V
C108	CK45F1H103Z	CAP. CERAMIC 0.01 50V
C109	CE04FW1A101M	CAP. ELECTRO 100 20% 10V
C110	CE04W1E101M	CAP. ELECTRO 100 20% 25V
C111	CE04FW1A101M	CAP. ELECTRO 100 20% 10V
C112	CE04W1E101M	CAP. ELECTRO 100 20% 25V
C113	CE04W1E101M	CAP. ELECTRO 100 20% 25V
C114	CE04FW1E330M	CAP. ELECTRO 33 20% 25V
C115	CQ92FM1H104K	CAP. MYLAR 0.1 10% 50V
C116	CE04FW1E330M	CAP. ELECTRO 33 20% 25V
C117	CC45CH1H101J	CAP. CERAMIC 100P 5% 50V
C118	CC45FCH1H100D	CAP. CERAMIC 10P 0.5P 50V
D001	1SS132	DIODE
D002	1SS132	DIODE
D003	1SS132	DIODE
D004	1SS132	DIODE
D005	1SS132	DIODE
D006	1SS132	DIODE
D007	1SS135	DIODE
D008	1SS132	DIODE
D009	MA700	DIODE
D010	MA700	DIODE
D011	1SS132	DIODE
D012	1SS132	DIODE
D013	NO USE	
D014	1SS132	DIODE
D015	1SS132	DIODE
D016	1SS132	DIODE

# PARTS LIST

REF. NO	PARTS NO	NAME & DESCRIPTION	REF. NO	PARTS NO	NAME & DESCRIPTION
D017	1SS83	DIODE	Q030	2SC2785(F)	TR. SI, NPN
D018	1SS132	DIODE	Q031	2SC2785(F)	TR. SI, NPN
D019	1SS132	DIODE	Q032	2SA1005(K)	TR. SI, PNP
D020	S2VB40F1	DIODE	Q033	2SC2785(F)	TR. SI, NPN
D021	S2VB40F1	DIODE	Q034	2SC2785(F)	TR. SI, NPN
D022	S1VB60	DIODE	Q035	2SC2785(F)	TR. SI, NPN
D023	MTZ16JA	DIODE ZENER 15V	Q036	2SC2785(F)	TR. SI, NPN
D024	MTZ16JA	DIODE ZENER 15V	Q037	2SC2785(F)	TR. SI, NPN
D025	MTZ5.1JB	DIODE ZENER 5V	Q038	2SC2785(F)	TR. SI, NPN
D026	1SS132	DIODE	Q039	2SC2786(K)	TR. SI, NPN
D027	1SS132	DIODE	Q040	2SC2786(K)	TR. SI, NPN
D028	1SS132	DIODE	Q041	2SC2785(F)	TR. SI, NPN
D029	1SS132	DIODE	Q042	2SC2785(F)	TR. SI, NPN
D030	1SS83	DIODE	Q043	2SC2909(S, T)	TR. SI, NPN
D031	1SS132	DIODE	Q044	2SC2909(S, T)	TR. SI, NPN
D032	MA700	DIODE	Q045	2SA1207(S, T)	TR. SI, PNP
D033	1SS132	DIODE	Q046	2SA1207(S, T)	TR. SI, PNP
D034	1SS132	DIODE	Q047	2SA1175(F)	TR. SI, PNP
D035	1SS132	DIODE	Q048	2SA1175(F)	TR. SI, PNP
D036	MTZ7.5JC	DIODE ZENER 7.5V	Q049	2SA1175(F)	TR. SI, PNP
D037	1SS132	DIODE	Q050	2SC2786(K)	TR. SI, NPN
J005	E31-2731-05	LEAD WIRE WITH CONNECTOR	Q051	2SC2785(F)	TR. SI, NPN
J008	E31-2732-05	LEAD WIRE WITH CONNECTOR	Q052	2SB940(P, Q)	TR. SI, PNP
J025	E31-2730-05	LEAD WIRE WITH CONNECTOR	Q053	2SB940(P, Q)	TR. SI, PNP
P002	E40-0374-05	PIN CONNECTOR 3 P	Q054	2SD1264(P, Q)	TR. SI, NPN
P005	E40-0573-05	PIN CONNECTOR 5 P	Q055	2SB940(P, Q)	TR. SI, PNP
P006	NO USE		Q056	2SC2909(S, T)	TR. SI, NPN
P007	E40-0273-05	PIN CONNECTOR 2 P	Q057	2SA1306B(O)	TR. SI, PNP
P008	E40-0273-05	PIN CONNECTOR 2 P	Q058	2SC2271(D)	TR. SI, NPN
P009	NO USE		Q059	2SD1264(P, Q)	TR. SI, NPN
P010	E40-0273-05	PIN CONNECTOR 2 P	Q060	2SC2785(F)	TR. SI, NPN
P011	NO USE		Q061	2SC1384(R, S)	TR. SI, NPN
P012	E40-0473-05	PIN CONNECTOR 4 P	Q062	2SA684(R, S)	TR. SI, PNP
P013	E40-1173-05	PIN CONNECTOR 11 P	Q063	2SC2785(F)	TR. SI, NPN
P014	E40-0373-05	PIN CONNECTOR 3 P	Q064	2SC3354(S, T)	TR. SI, NPN
P015	NO USE		Q065	2SA1175(F)	TR. SI, PNP
P016	E40-0273-05	PIN CONNECTOR 2 P	Q066	2SA1175(F)	TR. SI, PNP
P019	E40-0273-05	PIN CONNECTOR 2 P	Q067	2SA1175(F)	TR. SI, PNP
P020	NO USE		R001	RD14BB2E470J	RES. CARBON 47 5% 1/4W
P021	E40-0373-05	PIN CONNECTOR 3 P	R002	RD14BB2C122J	RES. CARBON 1.2K 5% 1/6W
P025	E40-0573-05	PIN CONNECTOR 5 P	R003	RD14BB2C103J	RES. CARBON 10K 5% 1/6W
P032	E40-1174-05	PIN CONNECTOR 11 P	R004	RD14BB2C470J	RES. CARBON 47 5% 1/6W
P036	E40-1004-05	PIN CONNECTOR 2 P	R005	RD14BB2C222J	RES. CARBON 2.2K 5% 1/6W
P040	E40-0274-05	PIN CONNECTOR 2 P	R006	RD14BB2C471J	RES. CARBON 470 5% 1/6W
P041	E40-0274-05	PIN CONNECTOR 2 P	R007	RD14BB2C102J	RES. CARBON 1K 5% 1/6W
Q001	2SC2785(F)	TR. SI, NPN	R008	RD14BB2C162J	RES. CARBON 1.6K 5% 1/6W
Q002	2SA1005(K)	TR. SI, PNP	R009	RD14BB2C471J	RES. CARBON 470 5% 1/6W
Q003	2SC3354(S, T)	TR. SI, NPN	R010	RD14BB2C103J	RES. CARBON 10K 5% 1/6W
Q004	2SC2785(F)	TR. SI, NPN	R011	RD14BB2C101J	RES. CARBON 100 5% 1/6W
Q005	2SA1005(K)	TR. SI, PNP	R012	RD14BB2C331J	RES. CARBON 330 5% 1/6W
Q006	2SC2786(K)	TR. SI, NPN	R013	RD14BB2C821J	RES. CARBON 820 5% 1/6W
Q007	2SC2785(F)	TR. SI, NPN	R014	RD14BB2C332J	RES. CARBON 3.3K 5% 1/6W
Q008	2SC2785(F)	TR. SI, NPN	R015	RD14BB2C682J	RES. CARBON 6.8K 5% 1/6W
Q009	2SC2785(F)	TR. SI, NPN	R016	RD14BB2C472J	RES. CARBON 4.7K 5% 1/6W
Q010	NO USE		R017	RD14BB2E471J	RES. CARBON 470 5% 1/4W
Q011	2SC2785(F)	TR. SI, NPN	R018	RD14BB2C101J	RES. CARBON 100 5% 1/6W
Q012	2SC2785(F)	TR. SI, NPN	R019	RD14BB2C223J	RES. CARBON 22K 5% 1/6W
Q013	2SC2785(F)	TR. SI, NPN	R020	RD14BB2C472J	RES. CARBON 4.7K 5% 1/6W
Q014	2SK304(F)	PET. N-CHANNEL	R021	RD14BB2C103J	RES. CARBON 10K 5% 1/6W
Q015	2SC2786(K)	TR. SI, NPN	R022	RD14BB2C562J	RES. CARBON 5.6K 5% 1/6W
Q016	2SC2785(F)	TR. SI, NPN	R023	RD14BB2C104J	RES. CARBON 100K 5% 1/6W
Q017	2SC2785(F)	TR. SI, NPN	R024	RD14BB2C473J	RES. CARBON 47K 5% 1/6W
Q018	2SA1175(F)	TR. SI, PNP	R025	RD14BB2C103J	RES. CARBON 10K 5% 1/6W
Q019	2SA1175(F)	TR. SI, PNP	R026	RD14BB2C105J	RES. CARBON 1M 5% 1/6W
Q020	2SA1175(F)	TR. SI, PNP	R027	RD14BB2C332J	RES. CARBON 3.3K 5% 1/6W
Q021	2SK117(Y)	PET. P-CHANNEL	R028	RD14BB2C622J	RES. CARBON 6.2K 5% 1/6W
Q022	2SC2785(F)	TR. SI, NPN	R029	NO USE	
Q023	2SC2785(F)	TR. SI, NPN	R030	RD14BB2C153J	RES. CARBON 15K 5% 1/6W
Q024	2SC2785(F)	TR. SI, NPN	R031	RD14BB2C102J	RES. CARBON 1K 5% 1/6W
Q025	2SA1175(F)	TR. SI, PNP	R032	RD14BB2C472J	RES. CARBON 4.7K 5% 1/6W
Q026	2SC2785(F)	TR. SI, NPN	R033	RD14BB2C103J	RES. CARBON 10K 5% 1/6W
Q027	2SA1175(F)	TR. SI, PNP	R034	RD14BB2E473J	RES. CARBON 47K 5% 1/4W
Q028	2SA1175(F)	TR. SI, PNP	R035	RD14BB2C103J	RES. CARBON 10K 5% 1/6W
Q029	2SA1175(F)	TR. SI, PNP	R036	RD14BB2E473J	RES. CARBON 47K 5% 1/4W
			R037	RD14BB2C682J	RES. CARBON 6.8K 5% 1/6W
			R038	RD14BB2C473J	RES. CARBON 47K 5% 1/6W
			R039	RD14BB2E105J	RES. CARBON 1M 5% 1/4W
			R040	RD14BB2C104J	RES. CARBON 100K 5% 1/6W
			R041	RD14BB2C103J	RES. CARBON 10K 5% 1/6W
			R042	RD14BB2C152J	RES. CARBON 1.5K 5% 1/6W
			R043	RD14BB2C152J	RES. CARBON 1.5K 5% 1/6W
			R044	RD14BB2C152J	RES. CARBON 1.5K 5% 1/6W
			R045	RD14BB2C222J	RES. CARBON 2.2K 5% 1/6W
			R046	RD14BB2C472J	RES. CARBON 4.7K 5% 1/6W

# PARTS LIST

REF. NO	PARTS NO	NAME & DESCRIPTION			
R047	RD14BB2C470J	RES. CARBON	47	5%	1/6W
R048	RD14BB2E472J	RES. CARBON	4.7K	5%	1/4W
R049	RD14BB2C104J	RES. CARBON	100K	5%	1/6W
R050	RD14BB2C182J	RES. CARBON	1.8K	5%	1/6W
R051	RD14BB2C103J	RES. CARBON	10K	5%	1/6W
R052	RD14BB2E473J	RES. CARBON	47K	5%	1/4W
R053	RD14BB2C102J	RES. CARBON	1K	5%	1/6W
R054	RD14BB2C222J	RES. CARBON	2.2K	5%	1/6W
R055	RD14BB2C152J	RES. CARBON	1.5K	5%	1/6W
R056	RD14BB2C152J	RES. CARBON	1.5K	5%	1/6W
R057	RD14BB2C152J	RES. CARBON	1.5K	5%	1/6W
R058	RD14BB2C152J	RES. CARBON	1.5K	5%	1/6W
R059	RD14BB2C152J	RES. CARBON	1.5K	5%	1/6W
R060	RD14BB2C152J	RES. CARBON	1.5K	5%	1/6W
R061	RD14BB2C152J	RES. CARBON	1.5K	5%	1/6W
R062	RD14BB2C621J	RES. CARBON	620	5%	1/6W
R063	NO USE				
R064	RD14BB2C472J	RES. CARBON	4.7K	5%	1/6W
R065	RD14BB2C472J	RES. CARBON	4.7K	5%	1/6W
R066	RD14BB2E271J	RES. CARBON	270	5%	1/4W
R067	RD14BB2C151J	RES. CARBON	150	5%	1/6W
R068	RD14BB2C471J	RES. CARBON	470	5%	1/6W
R069	RD14BB2C431J	RES. CARBON	430	5%	1/6W
R070	RD14BB2C102J	RES. CARBON	1K	5%	1/6W
R071	RD14BB2C331J	RES. CARBON	330	5%	1/6W
R072	RD14BB2C103J	RES. CARBON	10K	5%	1/6W
R073	RD14BB2E471J	RES. CARBON	470	5%	1/4W
R074	RD14BB2C103J	RES. CARBON	10K	5%	1/6W
R075	RS14GB3A682J	RES. METAL FILM	6.8K	5%	1W
R076	RN14BK2C3302F	RES. METAL FILM	33K	1%	1/6W
R077	RN14BK2C3002F	RES. METAL FILM	30K	1%	1/6W
R078	RD14BB2C472J	RES. CARBON	4.7K	5%	1/6W
R079	RD14BB2C182J	RES. CARBON	1.8K	5%	1/6W
R080	RD14BB2C820J	RES. CARBON	82	5%	1/6W
R081	RD14BB2C222J	RES. CARBON	2.2K	5%	1/6W
R082	RD14BB2C331J	RES. CARBON	330	5%	1/6W
R083	RD14BB2C471J	RES. CARBON	470	5%	1/6W
R084	RD14BB2C221J	RES. CARBON	220	5%	1/6W
R085	RD14BB2C182J	RES. CARBON	1.8K	5%	1/6W
R086	RD14BB2C102J	RES. CARBON	1K	5%	1/6W
R087	RD14BB2C272J	RES. CARBON	2.7K	5%	1/6W
R088	RD14BB2C182J	RES. CARBON	1.8K	5%	1/6W
R089	RD14BB2C822J	RES. CARBON	8.2K	5%	1/6W
R090	RD14BB2E681J	RES. CARBON	680	5%	1/4W
R091	RN14BK2E3004F	RES. METAL FILM	3M	1%	1/4W
R092	RN14BK2E1004F	RES. METAL FILM	1M	1%	1/4W
R093	RN14BK2E5003F	RES. METAL FILM	500K	1%	1/4W
R094	RN14BK2E3003F	RES. METAL FILM	300K	1%	1/4W
R095	RN14BK2E1003F	RES. METAL FILM	100K	1%	1/4W
R096	RN14BK2E5002F	RES. METAL FILM	50K	1%	1/4W
R097	RN14BK2E3002F	RES. METAL FILM	30K	1%	1/4W
R098	RN14BK2E2002F	RES. METAL FILM	20K	1%	1/4W
R099	RD14BB2C103J	RES. CARBON	10K	5%	1/6W
R100	RD14BB2C223J	RES. CARBON	22K	5%	1/6W
R101	RN14BK2C6201F	RES. METAL FILM	6.2K	1%	1/6W
R102	RD14BB2C622J	RES. CARBON	6.2K	5%	1/6W
R103	RD14BB2C101J	RES. CARBON	100	5%	1/6W
R104	RD14BB2C101J	RES. CARBON	100	5%	1/6W
R105	RD14BB2C103J	RES. CARBON	10K	5%	1/6W
R106	RD14BB2C132J	RES. CARBON	1.3K	5%	1/6W
R107	RN14BK2C1101F	RES. METAL FILM	1.1K	1%	1/6W
R108	RN14BK2C4701F	RES. METAL FILM	4.7K	1%	1/6W
R109	RN14BK2C4701F	RES. METAL FILM	4.7K	1%	1/6W
R110	RN14BK2C3301F	RES. METAL FILM	3.3K	1%	1/6W
R111	RD14BB2C101J	RES. CARBON	100	5%	1/6W
R112	RD14BB2C101J	RES. CARBON	100	5%	1/6W
R113	RD14BB2C472J	RES. CARBON	4.7K	5%	1/6W
R114	RD14BB2C472J	RES. CARBON	4.7K	5%	1/6W
R115	RD14BB2C101J	RES. CARBON	100	5%	1/6W
R116	RD14BB2C101J	RES. CARBON	100	5%	1/6W
R117	RD14BB2C752J	RES. CARBON	7.5K	5%	1/6W
R118	RD14BB2C752J	RES. CARBON	7.5K	5%	1/6W
R119	RD14BB2C821J	RES. CARBON	820	5%	1/6W
R120	RD14BB2C182J	RES. CARBON	1.8K	5%	1/6W
R121	RD14BB2C182J	RES. CARBON	1.8K	5%	1/6W
R122	RD14BB2C623J	RES. CARBON	62K	5%	1/6W
R123	RD14BB2C103J	RES. CARBON	10K	5%	1/6W
R124	NO USE				
R125	RD14BB2C271J	RES. CARBON	270	5%	1/6W
R126	RD14BB2C271J	RES. CARBON	270	5%	1/6W
R127	RD14BB2C331J	RES. CARBON	330	5%	1/6W
R128	RD14BB2C391J	RES. CARBON	390	5%	1/6W
R129	RD14BB2C100J	RES. CARBON	10	5%	1/6W
R132	RD14BB2C392J	RES. CARBON	3.9K	5%	1/6W

REF. NO	PARTS NO	NAME & DESCRIPTION			
R133	RD14BB2C392J	RES. CARBON	3.9K	5%	1/6W
R134	RN14BK2E6802F	RES. METAL FILM	68K	1%	1/4W
R135	RN14BK2E6802F	RES. METAL FILM	68K	1%	1/4W
R136	RD14BB2C102J	RES. CARBON	1K	5%	1/6W
R137	RD14BB2C102J	RES. CARBON	1K	5%	1/6W
R138	RD14BB2C154J	RES. CARBON	150K	5%	1/6W
R139	RD14BB2C682J	RES. CARBON	6.8K	5%	1/6W
R140	RD14BB2C182J	RES. CARBON	1.8K	5%	1/6W
R141	RD14BB2C182J	RES. CARBON	1.8K	5%	1/6W
R142	RD14BB2C271J	RES. CARBON	270	5%	1/6W
R143	RD14BB2C182J	RES. CARBON	1.8K	5%	1/6W
R144	RD14BB2C122J	RES. CARBON	1.2K	5%	1/6W
R145	RD14BB2C392J	RES. CARBON	3.9K	5%	1/6W
R146	RD14BB2C103J	RES. CARBON	10K	5%	1/6W
R147	RD14BB2C103J	RES. CARBON	10K	5%	1/6W
R148	RD14BB2C103J	RES. CARBON	10K	5%	1/6W
R149	RD14BB2C122J	RES. CARBON	1.2K	5%	1/6W
R150	RD14BB2C122J	RES. CARBON	1.2K	5%	1/6W
R151	RD14BB2C221J	RES. CARBON	220	5%	1/6W
R152	RD14BB2C102J	RES. CARBON	1K	5%	1/6W
R153	RD14BB2C473J	RES. CARBON	47K	5%	1/6W
R154	RD14BB2C472J	RES. CARBON	4.7K	5%	1/6W
R155	RD14BB2C472J	RES. CARBON	4.7K	5%	1/6W
R156	RD14BB2C102J	RES. CARBON	1K	5%	1/6W
R157	RD14BB2C102J	RES. CARBON	1K	5%	1/6W
R158	RD14BB2C102J	RES. CARBON	1K	5%	1/6W
R159	RD14BB2E104J	RES. CARBON	100K	5%	1/4W
R160	R92-1181-05	RES. CARBON	20	5%	3W
R161	NO USE				
R162	RD14BB2C222J	RES. CARBON	2.2K	5%	1/6W
R163	R92-1183-05	RES. CARBON	27	5%	5W
R164	RD14BB2C102J	RES. CARBON	1K	5%	1/6W
R165	RD14BB2C472J	RES. CARBON	4.7K	5%	1/6W
R166	RD14BB2C472J	RES. CARBON	4.7K	5%	1/6W
R167	RN14BK2C4701F	RES. METAL FILM	4.7K	1%	1/6W
R168	RN14BK2C4701F	RES. METAL FILM	4.7K	1%	1/6W
R169	R92-1183-05	RES. CARBON	27	5%	5W
R170	RN14BK2C3002F	RES. METAL FILM	30K	1%	1/6W
R171	RN14BK2C1002F	RES. METAL FILM	10K	1%	1/6W
R172	R92-1184-05	RES. CARBON	39	5%	5W
R173	RD14BB2C333J	RES. CARBON	33K	5%	1/6W
R174	RD14BB2C102J	RES. CARBON	1K	5%	1/6W
R175	RD14BB2C102J	RES. CARBON	1K	5%	1/6W
R176	RN14BK2C5602F	RES. METAL FILM	56K	1%	1/6W
R177	RN14BK2C5101F	RES. METAL FILM	5.1K	1%	1/6W
R178	R92-1182-05	RES. CARBON	3.3K	5%	3W
R179	RD14BB2E224J	RES. CARBON	220K	5%	1/4W
R180	RD14BB2C102J	RES. CARBON	1K	5%	1/6W
R181	RD14BB2C102J	RES. CARBON	1K	5%	1/6W
R182	RN14BK2C1003F	RES. METAL FILM	100K	1%	1/6W
R183	RN14BK2C4301F	RES. METAL FILM	4.3K	1%	1/6W
R184	RD14BB2E152J	RES. CARBON	1.5K	5%	1/4W
R185	RD14BB2C473J	RES. CARBON	47K	5%	1/6W
R186	RD14BB2C102J	RES. CARBON	1K	5%	1/6W
R187	RD14BB2C102J	RES. CARBON	1K	5%	1/6W
R188	RD14BB2C3R9J	RES. CARBON	3.9	5%	1/6W
R189	RD14BB2C102J	RES. CARBON	1K	5%	1/6W
R190	RD14BB2E220J	RES. CARBON	22	5%	1/4W
R191	RN14BK2C9102F	RES. METAL FILM	91K	1%	1/6W
R192	RN14BK2E1003F	RES. METAL FILM	100K	1%	1/4W
R193	RN14BK2C4302F	RES. METAL FILM	43K	1%	1/6W
R194	RD14BB2C104J	RES. CARBON	100K	5%	1/6W
R195	RD14BB2C471J	RES. CARBON	470	5%	1/6W
R196	RD14BB2C101J	RES. CARBON	100	5%	1/6W
R197	RD14BB2C561J	RES. CARBON	560	5%	1/6W
R198	RD14BB2C182J	RES. CARBON	1.8K	5%	1/6W
R199	RD14BB2C153J	RES. CARBON	15K	5%	1/6W
R200	RD14BB2C561J	RES. CARBON	560	5%	1/6W
R201	RD14BB2C472J	RES. CARBON	4.7K	5%	1/6W
R202	RD14BB2C821J	RES. CARBON	820	5%	1/6W
R203	RD14BB2C472J	RES. CARBON	4.7K	5%	1/6W
R204	RN14BK2C1002F	RES. METAL FILM	10K	1%	1/6W
R205	RN14BK2C1202F	RES. METAL FILM	12K	1%	1/6W
R206	RD14BB2C102J	RES. CARBON	1K	5%	1/6W
R207	RD14BB2C221J	RES. CARBON	220	5%	1/6W
R208	RN14BK2C3001F	RES. METAL FILM	3K	1%	1/6W
R209	RD14BB2E470J	RES. CARBON	47	5%	1/4W
R210	RD14BB2E470J	RES. CARBON	47	5%	1/4W
R211	RD14BB2E101J	RES. CARBON	100	5%	1/4W
R212	RD14BB2C562J	RES. CARBON	5.6K	5%	1/6W
R213	RD14BB2C432J	RES. CARBON	4.3K	5%	1/6W

# PARTS LIST

REF. NO	PARTS NO	NAME & DESCRIPTION
R214	RD14BB2C222J	RES. CARBON 2.2K 5% 1/6W
R215	RD14BB2C103J	RES. CARBON 10K 5% 1/6W
R216	RD14BB2C822J	RES. CARBON 8.2K 5% 1/6W
R217	RD14BB2E473J	RES. CARBON 47K 5% 1/4W
R218	RD14BB2E473J	RES. CARBON 47K 5% 1/4W
R219	RD14BB2C101J	RES. CARBON 100 5% 1/6W
R220	RD14BB2C221J	RES. CARBON 220 5% 1/6W
R221	RD14BB2C162J	RES. CARBON 1.6K 5% 1/6W
R222	RD14BB2C470J	RES. CARBON 47 5% 1/6W
R223	RD14BB2C103J	RES. CARBON 10K 5% 1/6W
R224	RD14BB2C103J	RES. CARBON 10K 5% 1/6W
R225	RD14BB2C221J	RES. CARBON 220 5% 1/6W
R226	RD14BB2C104J	RES. CARBON 100K 5% 1/6W
R227	RD14BB2C101J	RES. CARBON 100 5% 1/6W
R228	RD14BB2C101J	RES. CARBON 100 5% 1/6W
R229	RD14BB2C101J	RES. CARBON 100 5% 1/6W
R230	RD14BB2C151J	RES. CARBON 150 5% 1/6W
R231	RD14BB2C302J	RES. CARBON 3K 5% 1/6W
R232	RD14BB2C392J	RES. CARBON 3.9K 5% 1/6W
S001	S33-2501-05	LEVER SWITCH
S002	S37-2005-05	LEVER SWITCH
S003	S33-4503-05	LEVER SWITCH
S004	R01-3514-05	V.R. 20K B
S005	S03-2503-05	ROTARY SWITCH
S006	R01-3514-05	V.R. 20K B
TC001	C05-0445-05	CAP. TRIMMER 20P
TC002	C05-0445-05	CAP. TRIMMER 20P
TC003	C05-0448-05	CAP. TRIMMER 70P
U001	MC10107L	IC, QUAD 2-INPUT EXC OR/NOR
U002	MC10131L	IC, DUAL D-PFS
U003	MC10102L	IC, QUAD 2-INPUT NOR GATE
U004	SN74LS00N	IC, QUAD 2-INPUT NAND GATE
U005	SN74LS112AN	IC, DUAL JK-FF
U006	NJM4558D	IC, OP AMP
U007	NJM4558D	IC, OP AMP
U008	NJM4558D	IC, OP AMP
VR001	R01-3514-05	V.R. 20K B
VR002	S03-2503-05	ROTARY SWITCH
VR003	R01-3515-05	V.R. 10K B
VR004	R12-0563-05	RES. SEMI FIXED 500 B
VR005	R12-2517-05	RES. SEMI FIXED 10K B
VR006	R12-4510-05	RES. SEMI FIXED 50K B
VR007	R12-0563-05	RES. SEMI FIXED 500 B
VR008	R12-0561-05	RES. SEMI FIXED 100 B
VR009	R12-1528-05	RES. SEMI FIXED 1K B
VR010	R01-3514-05	V.R. 20K B
VR011	R29-9501-05	V.R. 10K B 200K B
VR012	R29-9501-05	V.R. 10K B 200K B
VR013	R12-1528-05	RES. SEMI FIXED 1K B

## CRT SOCKET UNIT

### X81-1600-00

REF. NO	PARTS NO	NAME & DESCRIPTION
	E01-0103-05	CRT SOCKET
	E23-0503-05	TERMINAL
	J25-5102-04	PCB (UNMOUNTED)
C001	CC45CH1H020C	CAP. CERAMIC 2P 0.25P 50V
C002	CC45CH1H010C	CAP. CERAMIC 1P 0.25P 50V
J001	E31-2611-05	LEAD WIRE WITH CONNECTOR
J002	E31-2612-05	LEAD WIRE WITH CONNECTOR
J003	NO USE	
J004	E31-2614-05	LEAD WIRE WITH CONNECTOR
L001	R92-0150-05	JUMPING RES. ZERO OHM
L002	R92-0150-05	JUMPING RES. ZERO OHM
R003	RD14BB2C6R8J	RES. CARBON 6.8 5% 1/6W
R004	RD14BB2E473J	RES. CARBON 47K 5% 1/4W

# WAVE FORM OF CIRCUIT DIAGRAM

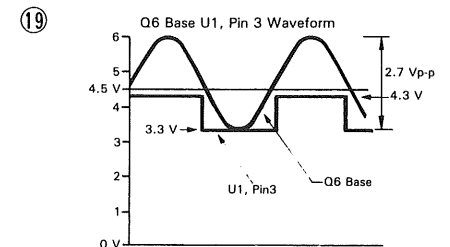
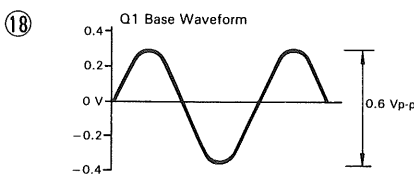
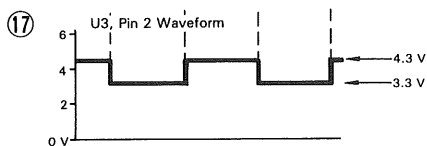
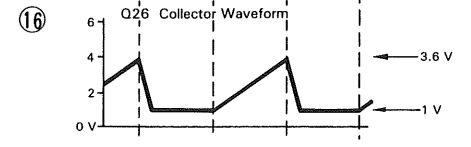
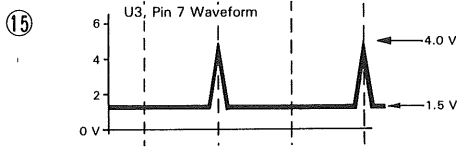
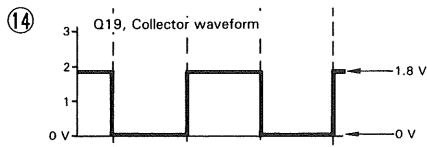
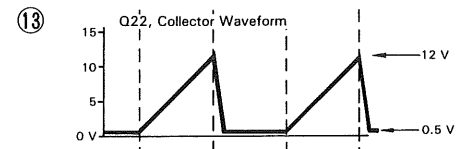
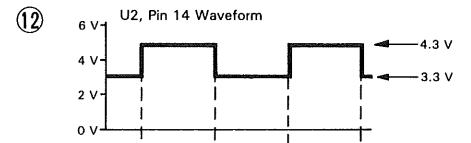
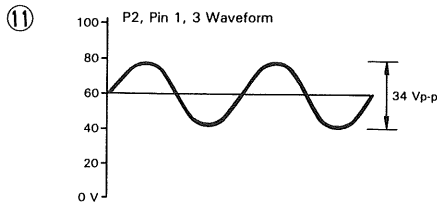
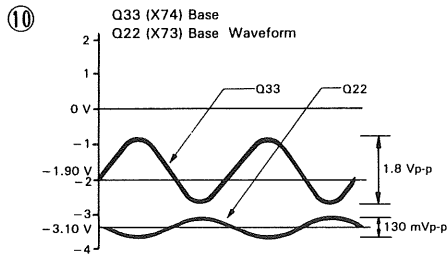
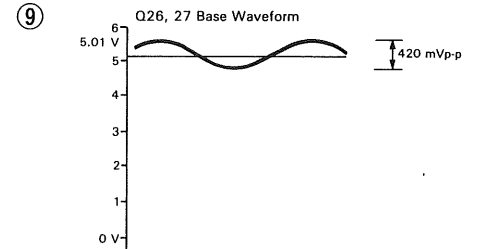
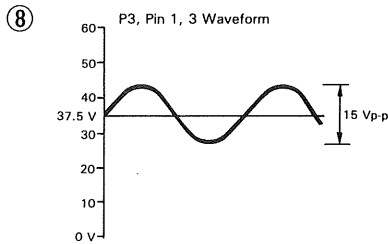
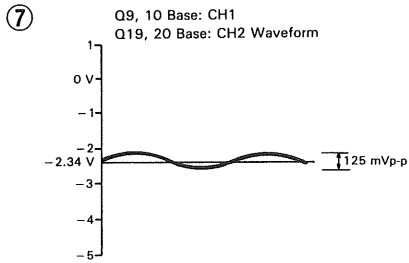
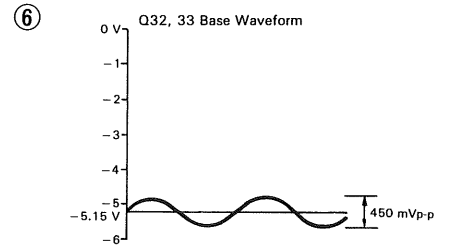
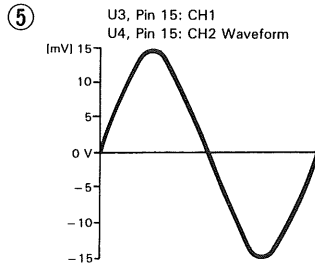
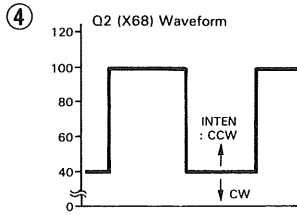
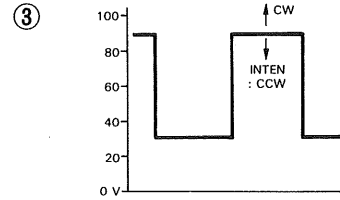
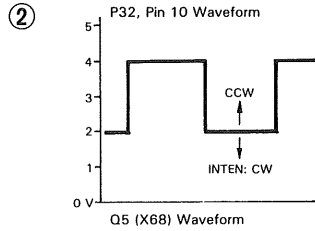
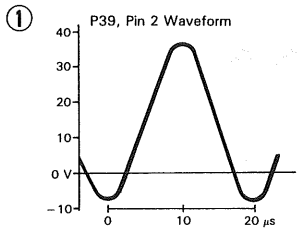

# SCHEMATIC DIAGRAM

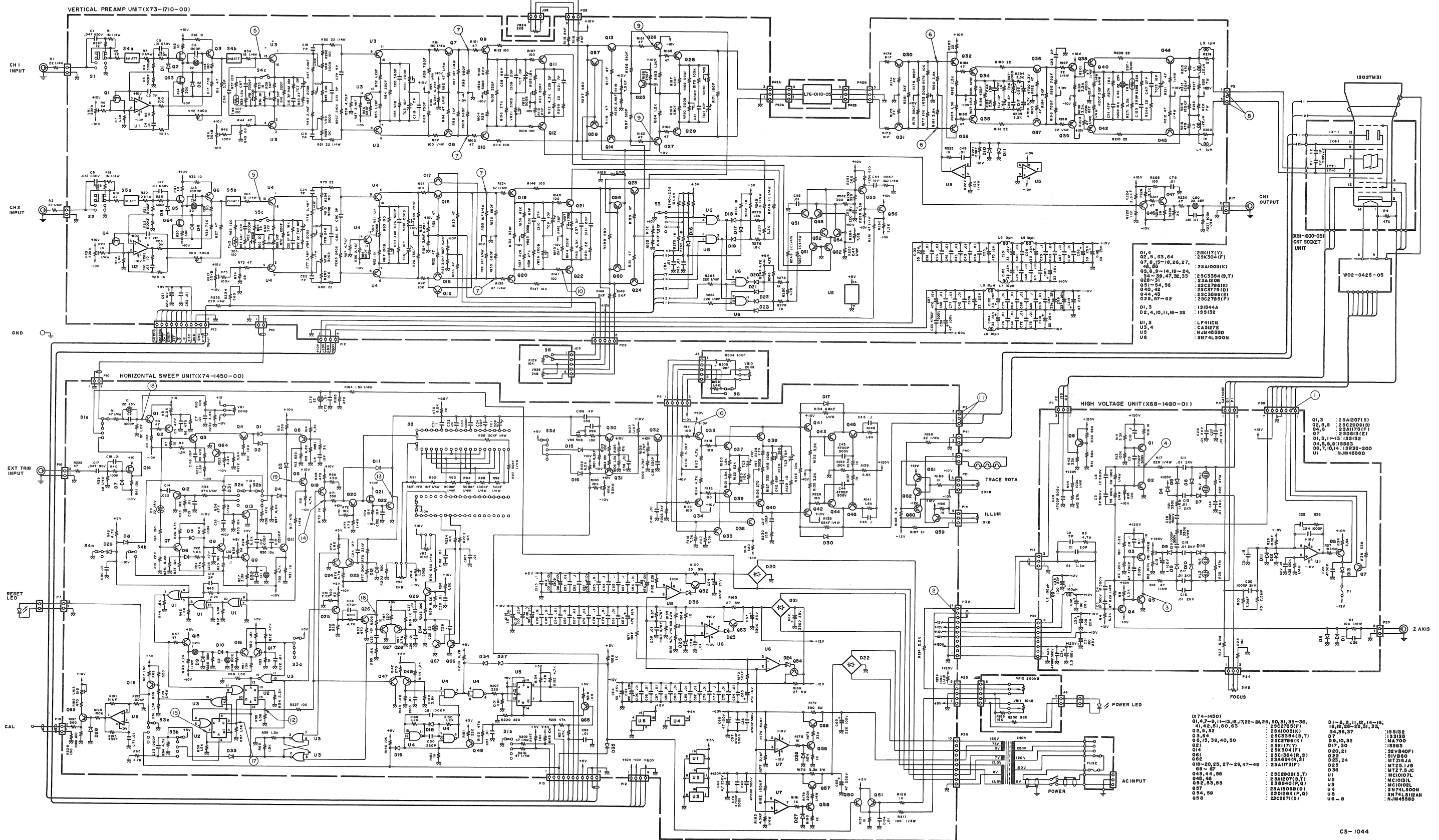

# P.C. BOARD

VERTICAL UNIT (X73-1710-00)

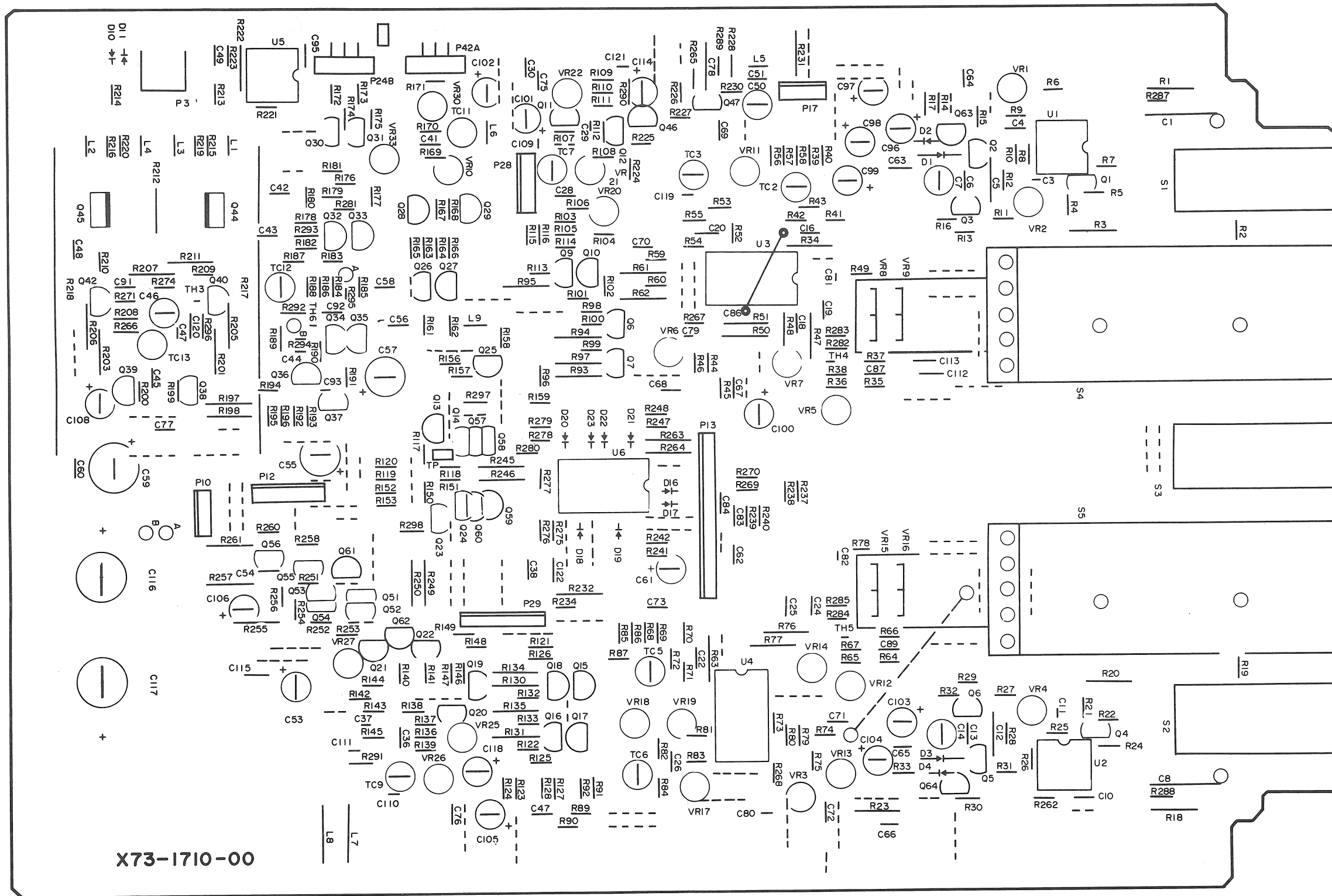



# P.C. BOARD

HORIZONTAL UNIT (X74-1450-00)

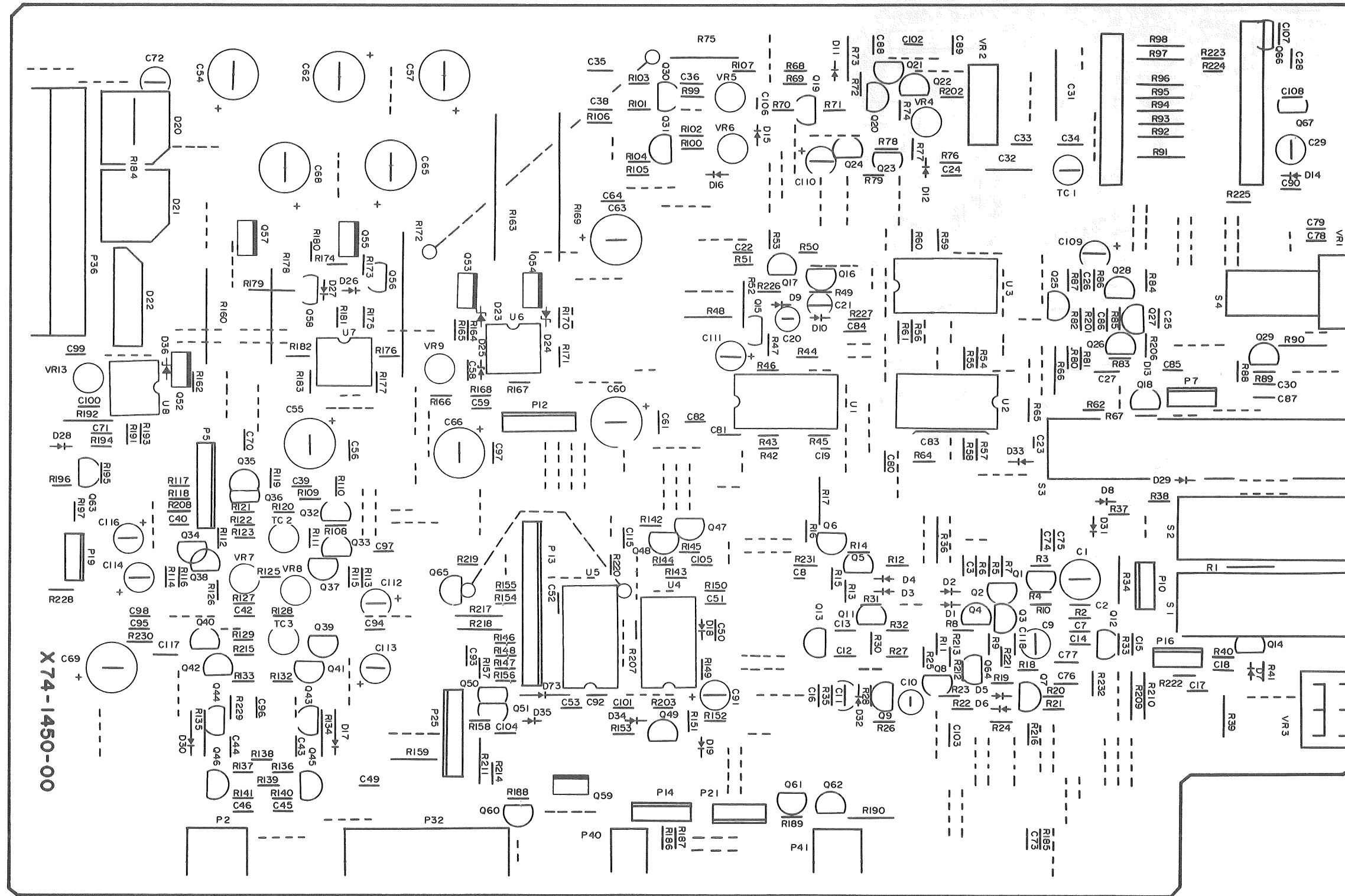

# P.C. BOARD

## HIGH VOLTAGE UNIT (X68-1460-01) Foil side view

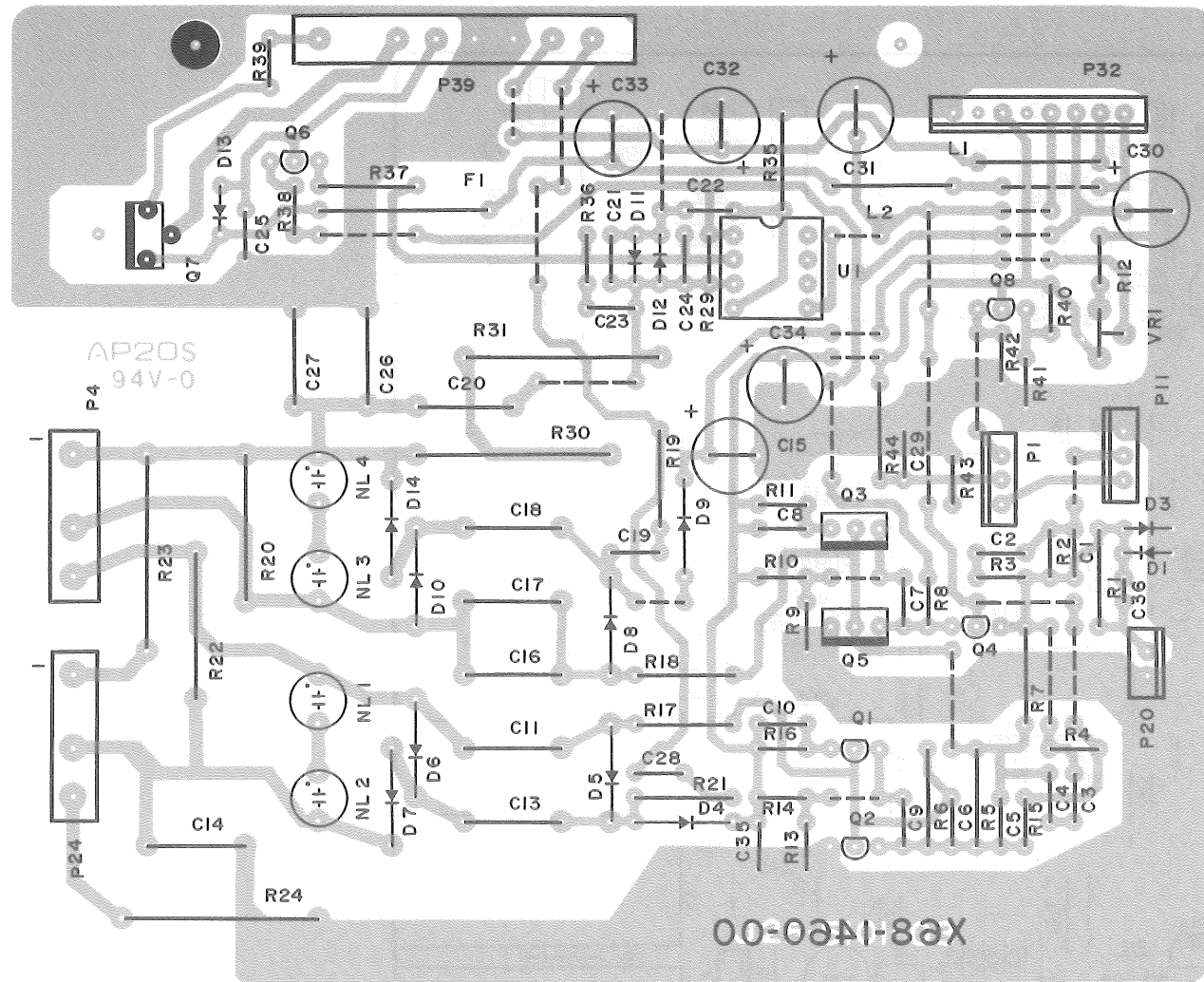

## CRT SOCKET UNIT (X81-1600-03) Foil side view

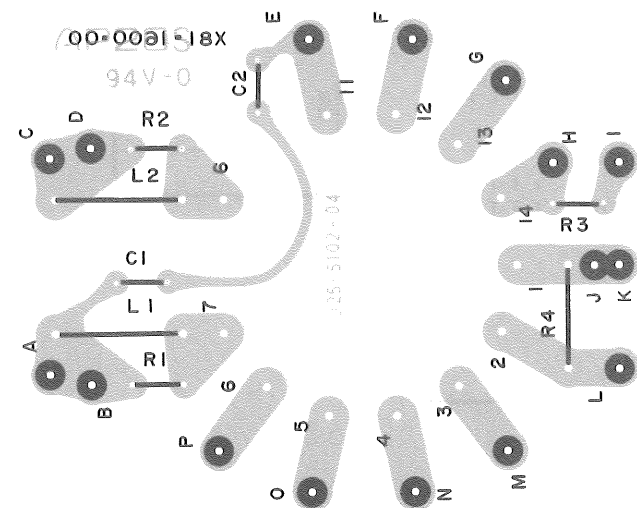

# DISASSEMBLY

3907 KOWA 1558

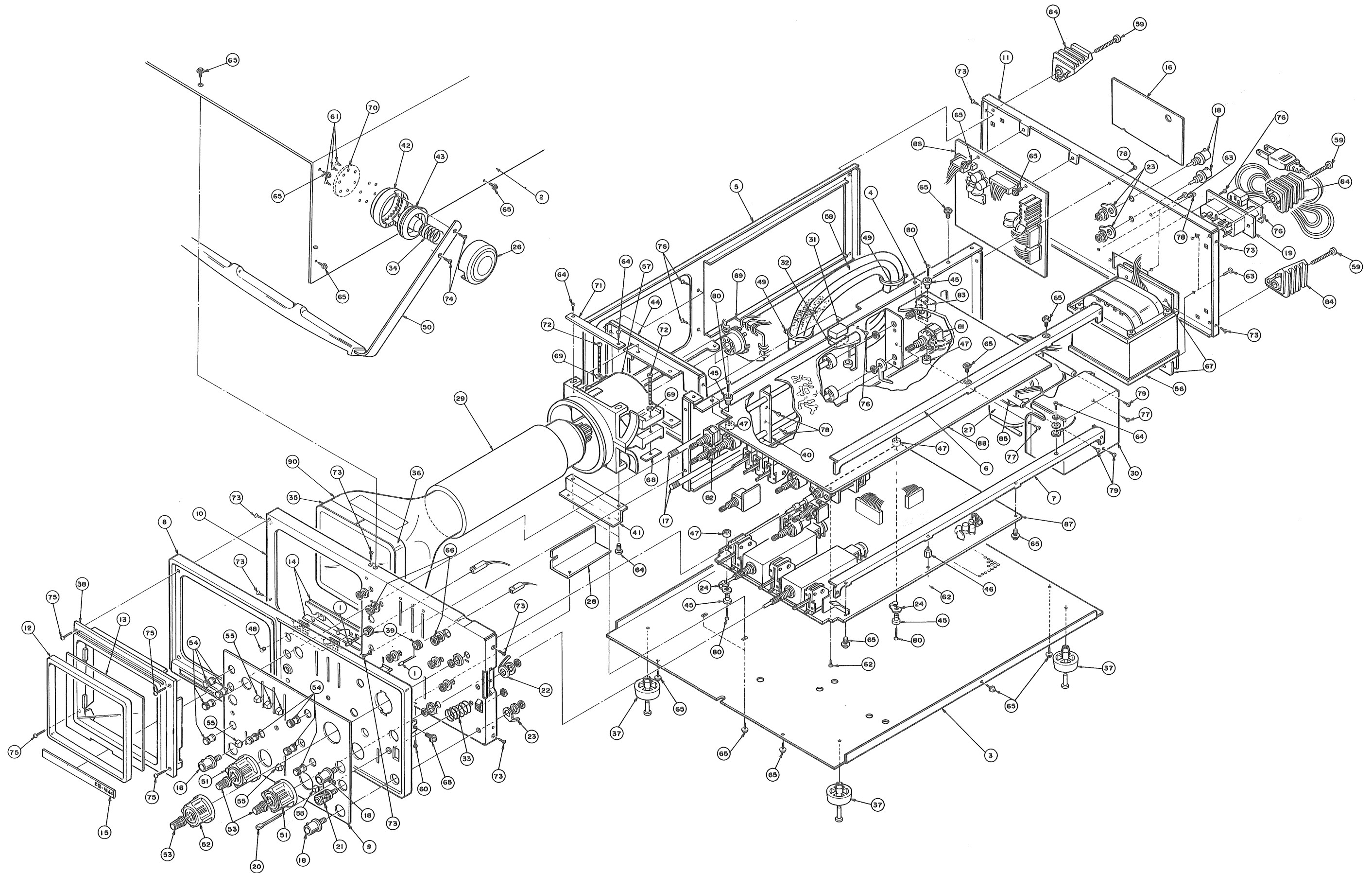

# SEMICONDUCTORS

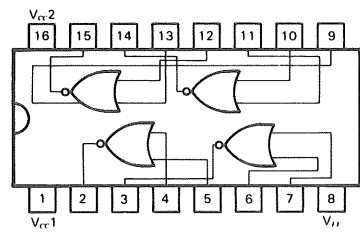

MC10102L

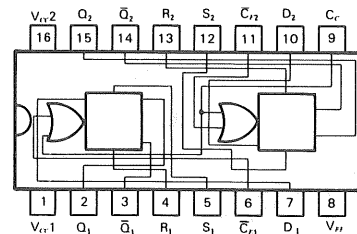

MC10131L

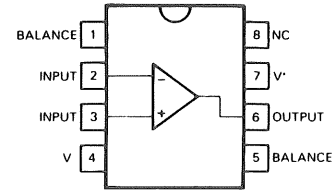

LF411CN

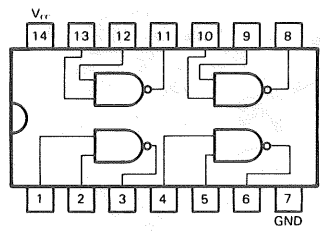

SN74LS00N

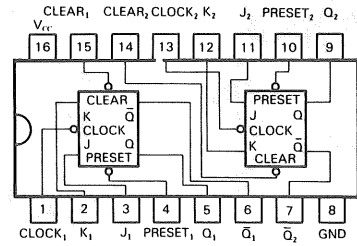

SN74LS112AN

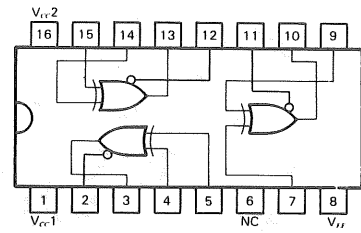

MC10107L

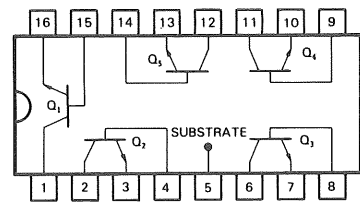

CA3127E

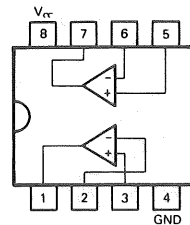

NJM4558

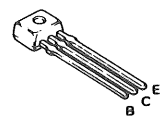

2SA1175 (F)  
2SC2785 (F)  
2SC2786 (K)

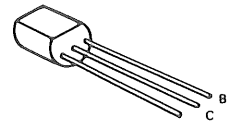

2SA684 (R,S)  
2SA1005 (K)  
2SC1384 (R,S)  
2SC2909 (S)  
2SC2909 (S,T)  
2SA1207 (S)  
2SA1207 (S,T)

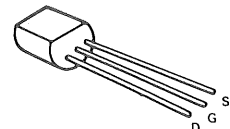

2SK117 (Y)

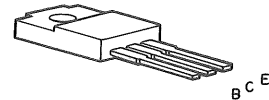

2SB940 (P,Q)  
2SD613 (E)  
2SA1306B (O)  
2SD1264 (P,Q)

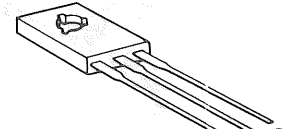

2SC3596 (F)

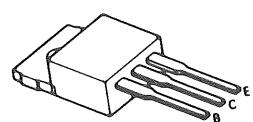

2SD613 (E)

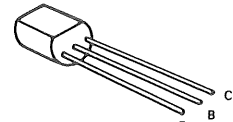

2SA1206

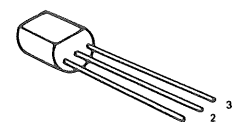

2SC3779D

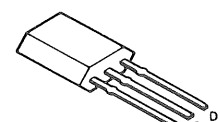

2SK304 (F)

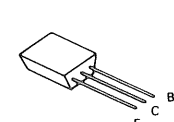

2SC3354 (S,T)

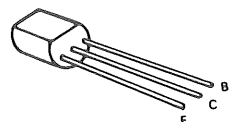

2SC2271D

A product of  
**KENWOOD CORPORATION**  
17-5, 2-chome, Shibuya, Shibuya-ku, Tokyo 150, Japan