



# TRIO

# SERVICE MANUAL

# CS-1554

DUAL-TRACE SYNCHROSCOPE

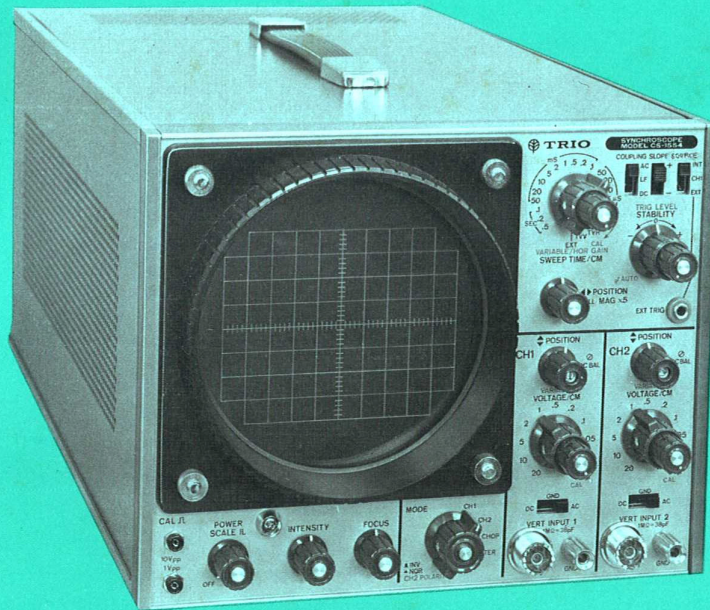

# CONTENTS

SPECIFICATIONS .....	3
CONTROLS AND CONNECTORS ON FRONT PANEL .....	4
CONTROLS AND CONNECTORS ON REAR PANEL .....	5
CIRCUIT DESCRIPTION .....	6 ~ 9
TROUBLE SHOOTING .....	10 ~ 18
VOLTAGE WAVEFORMS AT INDIVIDUAL POINTS OF CIRCUIT .....	19 ~ 20
ADJUSTMENT POINTS ON PC BOARD .....	21
ADJUSTMENT .....	22 ~ 27
PARTS LAYOUT (FRONT VIEW) .....	28
PARTS LAYOUT (REAR VIEW) .....	29
PARTS LAYOUT (TOP VIEW) .....	30
PARTS LAYOUT (SIDE VIEW) .....	31
PARTS LAYOUT (BOTTOM VIEW) .....	32
PC BOARD VERTICAL AMPLIFIER UNIT (X73-0011-00) .....	33
PC BOARD HORIZONTAL AMPLIFIER UNIT (X65-0008-01) .....	34
PARTS LIST OF CS-1554 .....	35 ~ 39
PARTS LIST OF X65-0008-01 .....	40 ~ 42
PARTS LIST OF X73-0011-00 .....	43 ~ 45
BLOCK DIAGRAM .....	45
SCHEMATIC DIAGRAM .....	46
COLOR CODE .....	47

# SPECIFICATIONS

**CATHODE RAY TUBE:** 130 ARB 1  
**VERTICAL SECTION** (Specifications common to both channels)

**Display:** CH1 only, CH2 only, CHOPPED, ALTERNATE and ADD

**Deflection sensitivity:** 0.01 V/cm - 20 V/cm  $\pm 5\%$ , continuously adjustable in all 11 ranges.

**Rise time:** 35 n sec.

**Input impedance:** 1 M $\Omega$  shunted by 38pF

**Frequency response:** DC DC  $\sim$  10 MHz (-3 dB)  
 AC 2Hz  $\sim$  10 MHz (-3 dB)

**Overshoot:** Less than 3% (100 kHz square wave)

**Sag:** Less than 5% (AC, 50 Hz square wave)

**Isolation between channels:** More than 55 dB at 1kHz

**Chopping frequency:** 140 kHz

**Polarity inversion:** CH2 signal can be inverted.

**Maximum input voltage:** 300V (DC + AC peak) or 600 Vpp

**SWEEP SECTION**

**Sweep rate:** 0.5  $\mu$ sec/cm  $\sim$  0.5 sec/cm  $\pm 5\%$ , continuously variable in all 19 ranges.  
 TV - V (3.6m sec/cm)  
 TV - H (13  $\mu$ sec/cm)

**Sweep magnification:** Each sweep rate can be increased 5 times by horizontally expanding the center portion of display.

**Linearity:** Better than 3% (0.5 sec/cm  $\sim$  2  $\mu$ sec/cm ranges)  
 Better than 5% (1  $\mu$ sec/cm  $\sim$  0.5  $\mu$ sec/cm ranges)

**SWEEP TRIGGERING**

**Mode:** Automatic triggering or adjustable triggering at desired level

**Source and signal requirement:** Internal triggering (with an input signal level providing more than 10mm deflection CH1 (with an input signal level

on the CRT)  
 more than 10m Vpp)  
 External triggering (with an input signal level more than 1 Vpp)

**Coupling:** AC 30 Hz  $\sim$  10 MHz (with AUTO position 50 Hz  $\sim$  10 MHz)  
 LF 5 Hz  $\sim$  10 kHz (with AUTO position 10 Hz  $\sim$  10 kHz)  
 DC DC  $\sim$  10 kHz (with AUTO position 10 Hz  $\sim$  10 kHz)

**Trigger slope:** Either positive or negative slope of the triggering signal

**EXTERNAL HORIZONTAL AMPLIFIER**

**Deflection sensitivity:** 250 mV/cm

**Frequency response:** DC  $\sim$  1 MHz (-3 dB)

**Input impedance:** 100 k $\Omega$  ( $\pm 20\%$ ) shunted by less than 60pF

**CALIBRATOR:**

10 Vpp and 1 Vpp  $\pm 5\%$ , 1 kHz square wave

**INTENSITY MODULATION**

**VOLTAGE:** More than 15 Vpp

**POWER REQUIREMENT:** 100V AC (117V, 230V) 50/60 Hz, 27 watts

**DIMENSIONS**

**(include all protrusion):**

Width	250 mm max.
Height	224 mm max.
Depth	438 mm max.
<b>WEIGHT:</b>	8.4 kg

**ACCESSORIES furnished**

**Probe (PC - 12) . . . 2:** Attenuation 1/10  
 Input impedance 10M $\Omega$  shunted by 15pF

**Cable assembly (CA - 36) . . . . . 1:** Shielded cable terminated on one end with a dual banana plug and on the other end with alligator clips.

**Instruction manual . . 1 (0.5A for 230V source) . . . . 3**

# CONTROLS AND CONNECTORS ON FRONT PANEL(1)

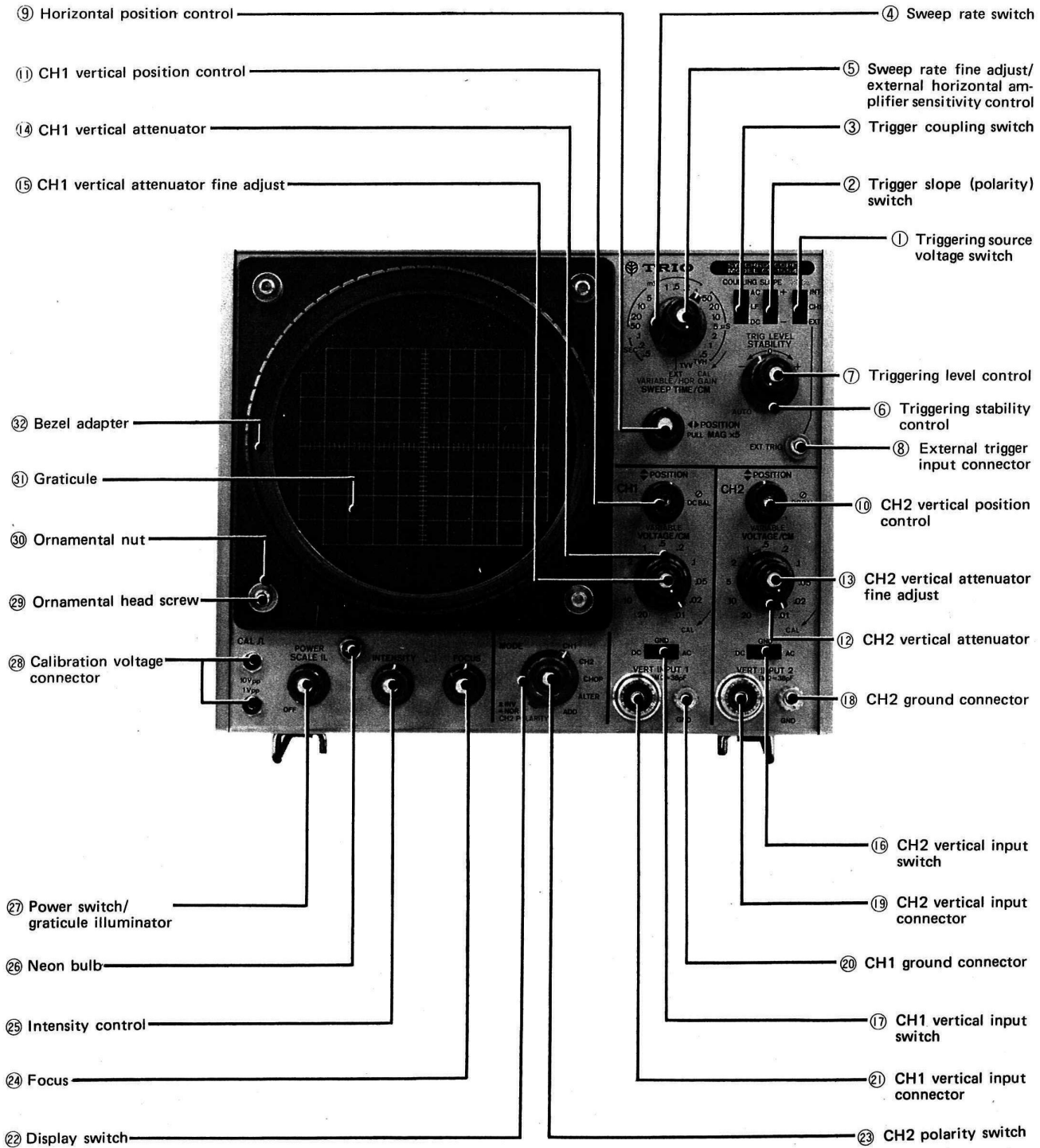

## CONTROLS AND CONNECTORS ON REAR PANEL(2)

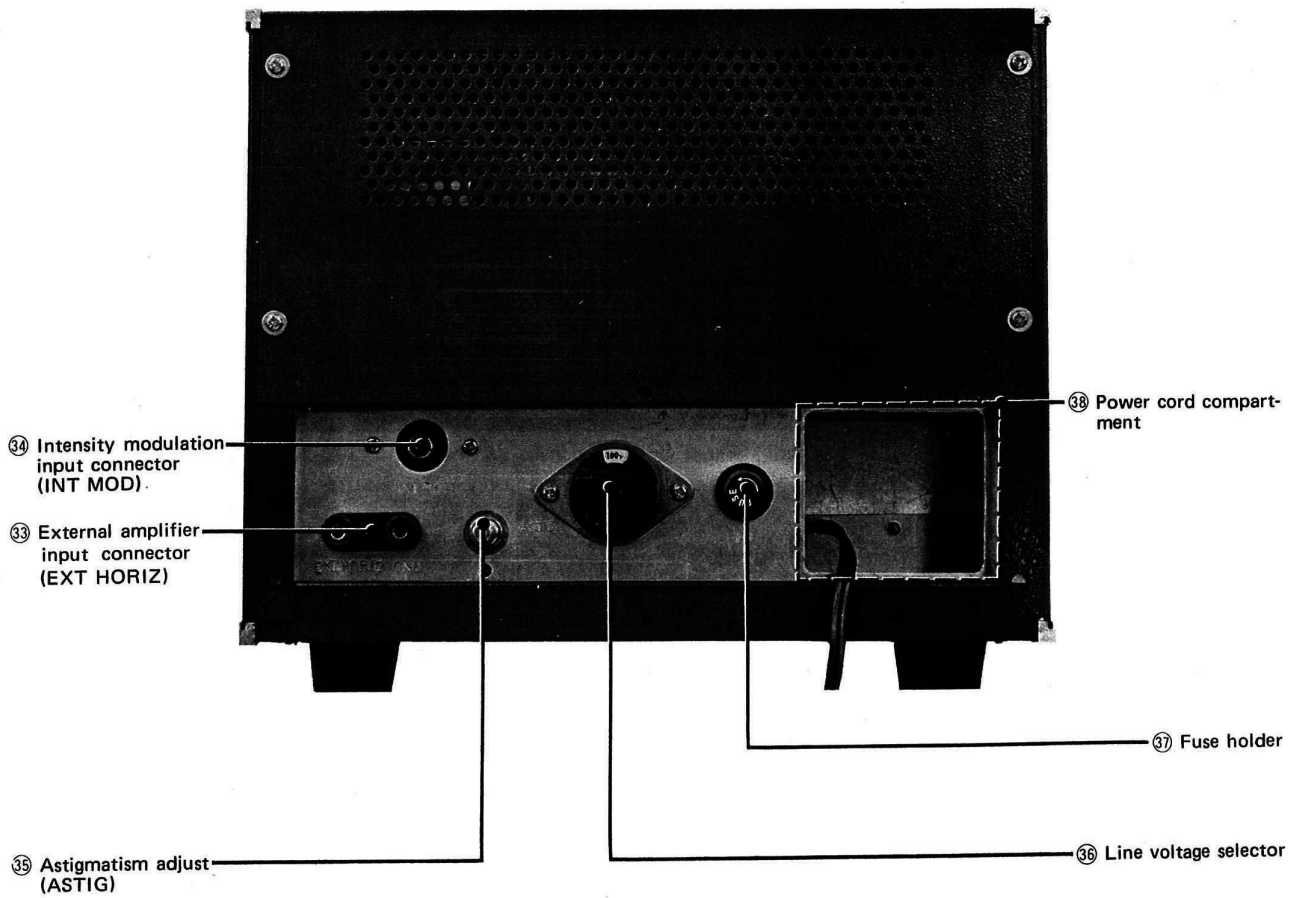

# CIRCUIT DESCRIPTION

NOTE: Components numbers given in parenthesis apply to CH1.

## 1. VERTICAL SECTION (X73-0011-00)

### 1) INPUT CIRCUIT AND ATTENUATOR

Input signals applied to the VERTICAL INPUT 1 and 2 connectors can be ac-coupled, dc-coupled or internally disconnected by the AC-GND-DC selector switch. The signals passed through the switch are coupled to the frequency-compensated attenuators and are reduced to the desired level. The input impedance of each channel is  $1\text{ M}\Omega$  shunted by  $38\text{ pF}$  through 11 ranges.

### 2) VERTICAL AMPLIFIER

The output signals from the attenuator networks are applied through the excessive input protection circuit using FET (Field Effect Transistor) Q2 (Q4) to the vertical Amplifier. The protection circuit, utilizing the diode characteristic of FET limits  $V_{GDS}$  of Q5 (Q7) to below 1 volt. FET Q5 (Q7) is used as source followers to provide a high input impedance to the input circuit. Also, FET Q6 (Q8) is used to form a balanced circuit for reducing the effect of drift due to variation of power source voltage and temperature. Further, the following stages Q9, 10 (Q11, 12) provide a low output impedance and their output signals are connected to differential amplifier's Q13, 14 (Q15, 16).

The dc level is adjusted by the DC BAL source resistor VR101a (VR102a) to obtain the balance of the emitter GAIN circuit. VR103, VR1 (VR104, VR3) placed in the emitters of Q13, 14 (Q15, 16) respectively, provide the gain adjustment, and Q17, 18 VR101b VR2 (Q19, 20 VR102b VR4) shift the dc level to position the trace on the CRT at the proper position horizontally. The signal from CH1 is coupled directly to the dual-trace switching gate, the signal from CH2 is coupled through the CH2 POLARITY switch to the dual-trace switching gate circuit.

The dual-trace switching gate determines whether the CH1 signal or CH2 signal passes on to the differential amplifier Q23 ~ Q26 through the emitter follower Q21 ~ 22.

This amplifier Q23 ~ Q26 is connected in a cascade connection to reduce the Miller effect to the signal in the higher RF region. This allows the differential amplifier to provide sufficient bandwidth.

The output signal of the differential amplifier is fed through Q27, Q28 which presents low output impedance, to final stage amplifier. Also, the same output signal is fed through Q43 and Q44 serving as buffer and level shifter to the sweep trigger circuit for the internal trigger source. VR6 (INT DC ADJ) provides dc level adjustment of the trigger signal at zero volts.

The final stage Q29 ~ Q32, which forms a cascade differential circuit is a frequency-compensated amplifier. In this stage, the signal is sufficiently amplified and directly connected to the vertical deflection plates of the CRT. The overall gain of the vertical amplifier is approximately 60 dB, which corresponds to a deflection sensitivity (factor) of  $10\text{ mV/cm}$  measured on the CRT screen. Also, the frequency response of the vertical amplifier is DC to 10 MHz (-3 dB).

### 3) DUAL-TRACE SWITCHING GATE CIRCUIT

D1 ~ D4 (D5 ~ D8) form the switching gate circuit. The four-diode gate can be considered as a switch that selects the channel signal desired at

## CIRCUIT DESCRIPTION

the output amplifier. Two square wave outputs that are opposite in phase are produced from the switching multivibrator Q41, Q42 and are used to turn the four-diode gate circuits on and off. Thus, the preceding vertical amplifiers are switched alternately by the switching gate.

### 4) SWITCHING MULTIVIBRATOR AND CHOP-BLANKING CIRCUIT

The multivibrator Q41, Q42 is operated as a flip-flop or an astable multivibrator by biasing transistors. In the CHOP mode, the multivibrator operates as an astable multivibrator with 140 kHz repetition rate, from which the square wave output turns the four-diode gates on and off.

In the ALTER mode, the multivibrator operates as a flip-flop. Then, the signal to trigger the multivibrator is applied from the gate multivibrator in the sweep circuit through the unblanking amplifier and triggering circuit to the bases of Q41, Q42. Accordingly, at the end of each sweep, the output of the flip-flop is inverted and turns the four-diode gate on and off.

In the ADD mode, the power supply to the switching multivibrator is disconnected. Therefore, the four-diode gates of both channels are opened, and the added signal of CH1 and CH2 signal is connected to the output amplifier. In the CHOP mode, when the multivibrator is inverted, the pulse appears at the emitter of the multivibrator.

The pulse is amplified by Q45. This pulse and the unblanking signal are coupled to the first grid of the CRT for unblanking the switching interval trace and transient distortion during the chopping period.

### 5) TRIGGER SIGNAL AMPLIFIER

In the CH1 position of the SOURCE switch, the sweep is triggered by the signal applied from CH1 only.

Therefore, the trigger signal is applied from the emitter of Q11 (with a low output impedance), placed in front of the switching gate circuit, to the emitter follower Q33, Q47 which offers no disturbance to the preceding stage. For elimination of drift, the circuit is composed as a balanced amplifier. Further, the trigger signal is connected through Q34, Q35 (amplifier), Q36, Q37 (serving as impedance converter), PNP junction Q38, Q39 (amplifier and level shifter) and Q40 (emitter follower with a low output impedance) to the sweep trigger circuit.

The dc level of the trigger signal amplified in the above stages is adjusted by the emitter resistor VR5.

## 2. SWEEP TRIGGER CIRCUIT (X65-0008-01)

### 1) PHASE INVERTER AND LIMITER CIRCUIT

The SOURCE switch determines the source of the trigger signal to be coupled to this stage Q6, Q7. This circuit is a differential amplifier with a ground potential at its input. Because of its narrowed dynamic range, the level of its input signal is limited to a certain level. At the same time, this stage operates as a phase inverter. That is, in the positive (+) position of the SLOPE switch, the trigger signal is coupled to the base of Q6. While in the negative (-) position, the signal is coupled to the base of Q7, this causes the circuit to deliver the phase inverted output. In the above operation, the transistor with no input signal is biased through VR105a to adjust the triggering level. Also, in the AUTO position, the circuit with a ground potential input is biased with a fixed bias.

## CIRCUIT DESCRIPTION

In the AC position of the MODE switch, the dc component of the trigger signal is blocked by the coupling capacitor C110 and the ac component of trigger signal is coupled to the SLOPE switch. In this position, triggering frequency bandwidth is 30 Hz ~ 10 MHz (50 Hz ~ 10 MHz, in the AUTO position). In the LF position, since noise and unwanted components of the chopping signal are rejected by the capacitor C111 (placed in the input circuit), triggering frequency bandwidth is limited to a very low frequency i. e. 5 Hz ~ 10 kHz (10 Hz ~ 10 kHz in the AUTO position). In the DC position, the sweep is triggered with frequencies down to dc, since the trigger signal is directly coupled to the sweep trigger circuit. Also, as in the LF position, the capacitor C111 is placed in the input circuit, and the triggering frequency bandwidth is DC ~ 10 kHz.

### 2) SQUARE WAVE SHAPER CIRCUIT

This stage consists of the Schmitt Circuit Q8, Q9 mainly. In this circuit, when the input level of the trigger signal reaches a certain level, the Schmitt Circuit produces a uniform square wave with a constant level coincident with the input signal. This square wave is coupled through the differentiation circuit to the gate multivibrator Q10 ~ Q13 as the triggering signal. When in the AUTO position, the bistable multivibrator is turned into an astable multivibrator with 40 ~ 50 Hz repetition rate. Under these conditions, if the input signal is not applied the sweep repetition rate is 40 ~ 50 Hz. Since this astable multivibrator is level sensitive, it will be easily pulled into synchronization with the input signal if supplied.

### 3. SWEEP CIRCUIT (X65-0008-01)

#### 1) GATE MULTIVIBRATOR, MILLER INTEGRATOR AND HOLD-OFF CIRCUIT

The gate multivibrator Q10 ~ Q13, i. e. a bistable multivibrator of the square wave shaper circuit, the Miller integrator Q17 ~ Q20 and the hold-off circuit, Q14, which is driven under control from the triggering signal, form a dc loop to generate a sawtooth wave. When the STABILITY control is adjusted, the multivibrator is conditioned to invert its state on the incoming trigger signal. That is, when the triggering signal is fed from the square wave shaper, the state of the multivibrator is changed and the switching diodes D3 and D4 are turned off.

This charges the time-base capacitors inserted in the gate circuit of FET Q17 in accordance with the time constant determined by the value of the time-base resistor and resistor. This charging signal is received through a high input impedance FET Q17, from which it is applied to the following stage Q18, Q19 amplify the charging signal, and invert the phase.

The output of the emitter follower Q20 with a low output impedance feed the horizontal amplifier. The amplified signal is the sweep voltage to the horizontal deflection plates of the CRT which displays the trace.

A part of the output of Q20 is fed back to one side of the time-base capacitor mentioned above. This enables the time-base capacitor to be charged with a constant current, thereby providing a linear sawtooth wave. The hold-off circuit provides delay for the charging waveform back to the input of the gate multivibrator until it reaches a given level, then it inverts the state of the gate multivibrator to the original condition to complete one sweep.



# CIRCUIT DESCRIPTION

## 2) INVERTER CIRCUIT

The gate multivibrator produces a negative pulse for the output signal during a display. To obtain a positive pulse for the unblanking signal, this pulse is inverted in phase by Q15. The positive signal produced, together with the chop-blanking signal, is coupled to the grid of the CRT. This cuts off the CRT in the period of the blanking without input signal. Also, in the ALTER mode the output of the inverter is coupled through the differentiation circuit to the triggering circuit providing a trigger pulse for driving the flip-flop Q41, Q42 (X73-0011-00).

## 3) HORIZONTAL AMPLIFIER CIRCUIT

The sawtooth wave output of the Miller circuit is applied to emitter follower Q21, with a low output impedance. The output of emitter follower is fed to the differential amplifier Q22, Q23.

The variable resistor VR6 (MAG CENT) provides the shift of the bias of D23 to adjust the dc balance, which may be changed when the MAG switch is pulled out or in. The amplifier is also provided with a variable resistor VR7 (POS ADJ1) which is inserted between the emitter resistor R54 and R55 of Q22, D23, and provides a horizontal waveform position adjust on the CRT screen. To obtain the rated gain as selected by the MAG switch, the switch provides selection of VR8 (GAIN ADJ) and VR9 (MAG ADJ) inserted in the emitter circuit of Q22, Q23. In the case where the trace is swept by an external signal, the signal is connected from the EXT HORIZ connector to the variable resistor VR106b (GAIN), where gain is adjusted. The signal from VR106b is applied to FET Q16 (serving as an impedance converter) and then to the horizontal amplifier mentioned above.

The variable resistor VR4 (POS ADJ2) is provided to adjust the dc level of the external signal to the same level as the mean voltage of the internal sweep signal in order to position the waveform to the horizontal center of the CRT screen. In this case, the horizontal amplifier provides a deflection sensitivity (factor) of 250 mV/cm and a frequency bandwidth of DC ~ 1 MHz (- 3 dB).

## 4. CALIBRATOR CIRCUIT (X65-0008-01)

The calibrator consists of 1 kHz multivibrator Q1, Q2 and the Schmitt circuit. The output of the 1 kHz multivibrator is fed to the Schmitt circuit. The Schmitt circuit turns the 1 kHz signal from the multivibrator into the square wave signal which is connected to the resistor voltage divider. Thus, calibration voltages of 10 Vpp and 1Vpp are delivered to the respective CAL terminals.

## 5. POWER SUPPLY CIRCUIT (Chassis and X65-0008-01)

The AC source voltage is applied to the primary windings of the power transformer. The source voltage is induced across the high voltage secondary windings and is rectified by high voltage selenium rectifiers D101 and D102. A voltage doubler provides high voltage for the CRT. The voltage induced across the low voltage secondary windings of the transformer is rectified by diodes D104, D105, D9 and D10 to provide the B supply voltage. The low voltages for the vertical and horizontal amplifiers are supplied by the stabilized B supply through regulator Q24 and Zener diode D7.

## TROUBLE SHOOTING

### REMOVAL OF CABINET PLATES

1. Remove four screws located on the rear-panel of the instrument.
2. While holding the top plate at the handle, slide the plate backward approximately 10mm and lift upward, then it comes off the side frames quite easily.
3. Slide the side plate backward after removal of the top plate until they come off the side frame.
4. Remove six screws located on the bottom plate. Draw the plate backward while lifting its rear end up slightly and it comes off the side frames.

**NOTE:** The side plate and top plate can be separated independently.

**CAUTION:** When performing the above procedure, always turn off the power. Also, be careful not to touch 2500 volt section after removal of the case plates.

### ASSEMBLY OF CABINET PLATES

To assemble the cabinet plates to the case frames, reverse the order given in REMOVAL of CABINET PLATES above. Note that the top plate should be assembled to the frames while sliding it forward with the handle being depressed by the hand.

**CAUTION:** When performing the above procedure, be careful not to touch a cathode ray tube socket, of which the metallic parts assume high voltage (1300V).

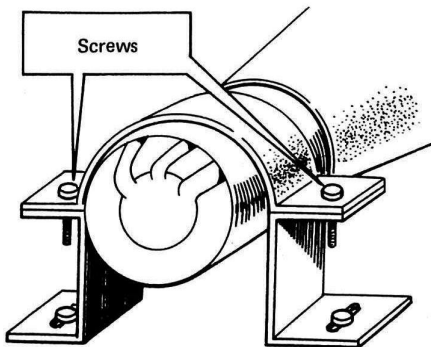
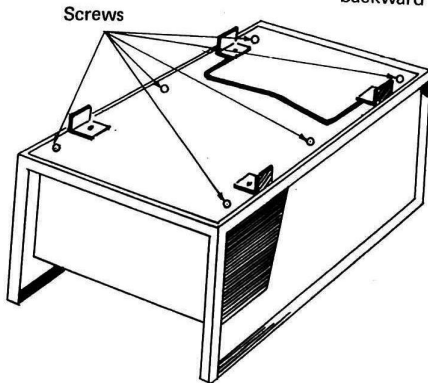
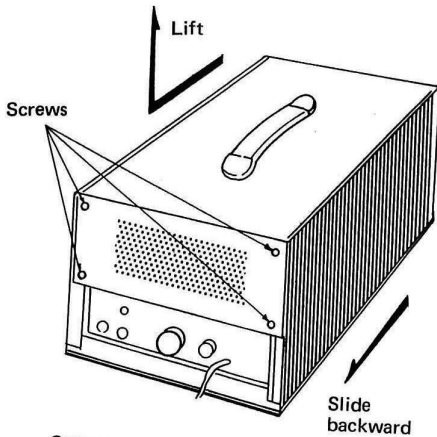

# TROUBLE SHOOTING

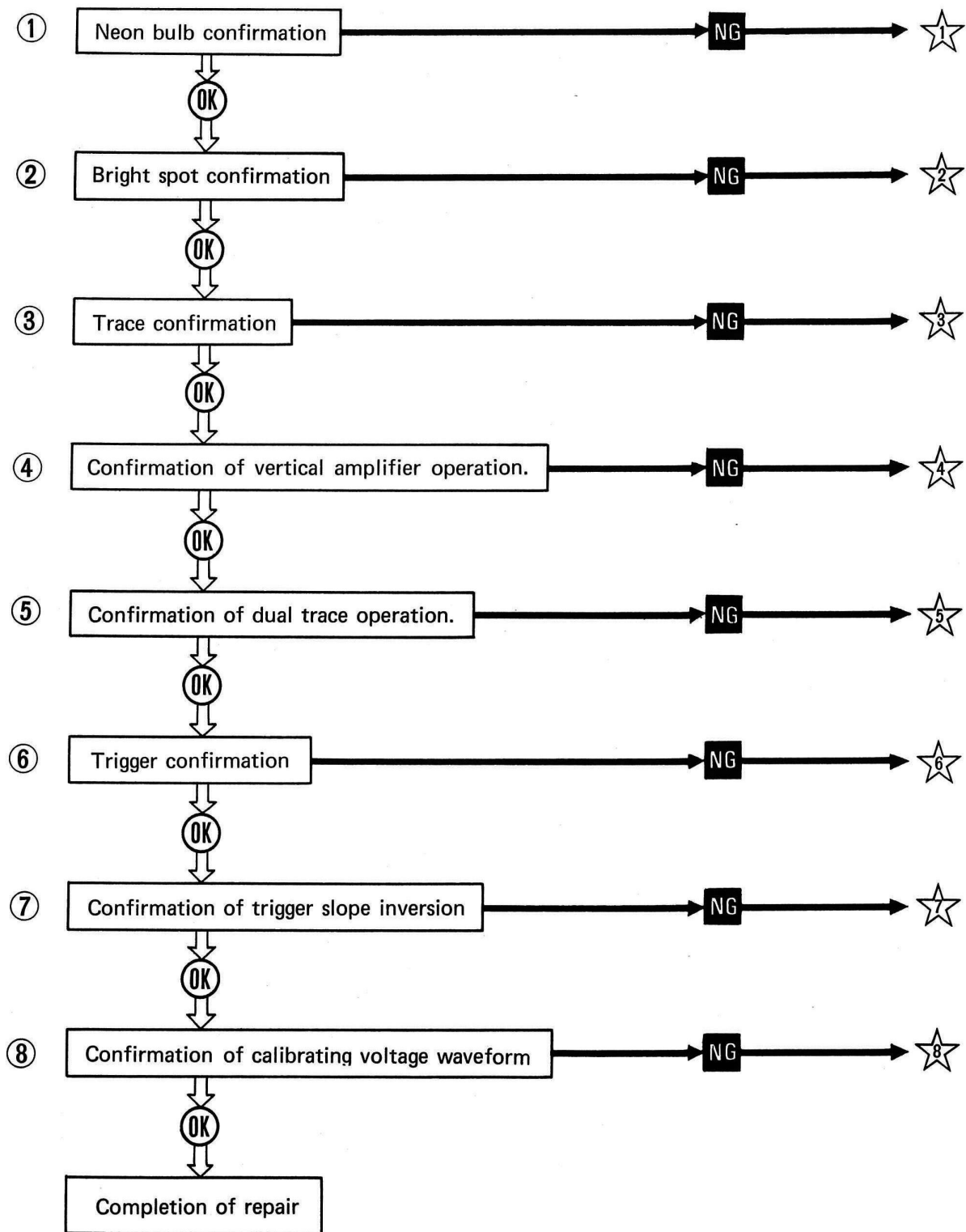

# TROUBLE SHOOTING

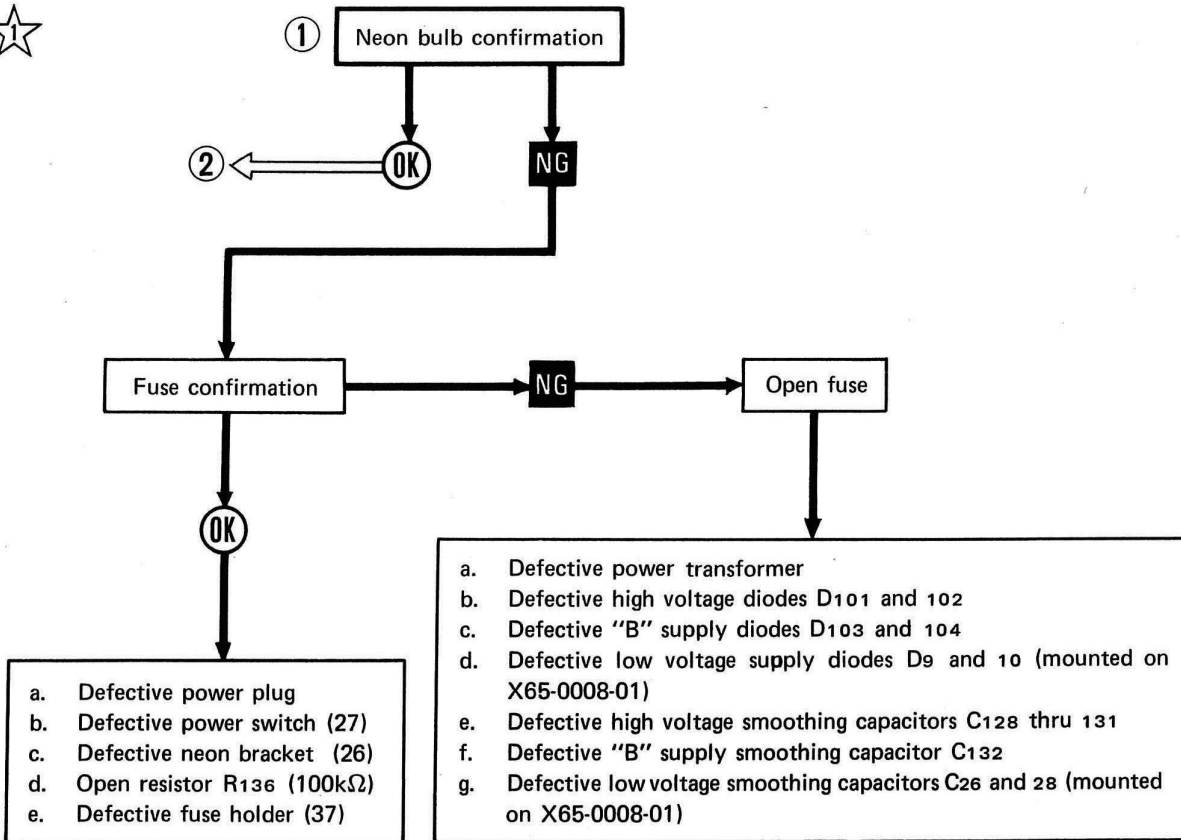

# TROUBLE SHOOTING

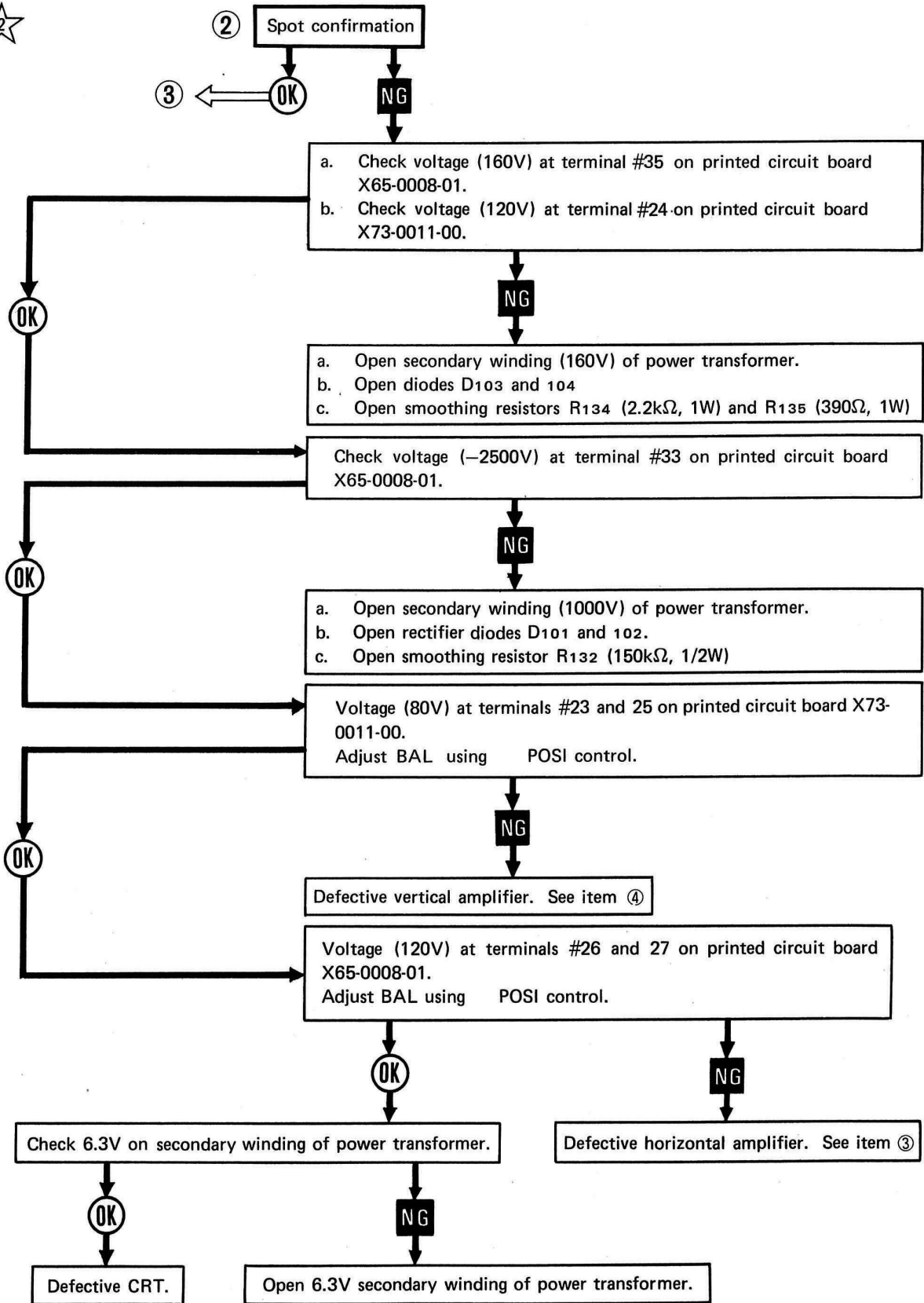

# TROUBLE SHOOTING

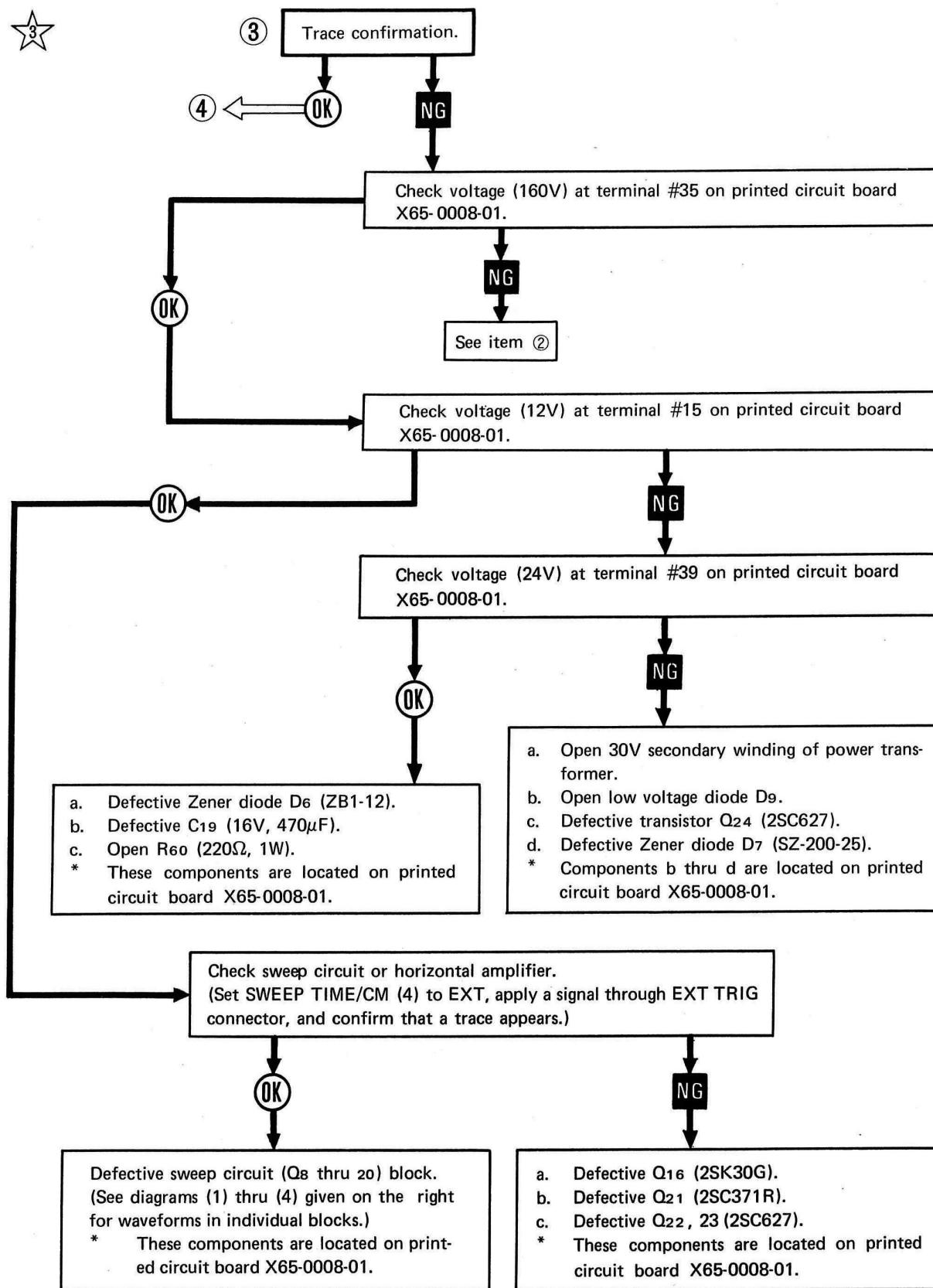

# TROUBLE SHOOTING

NOTE: The components are located on printed circuit board X73-0011-00.

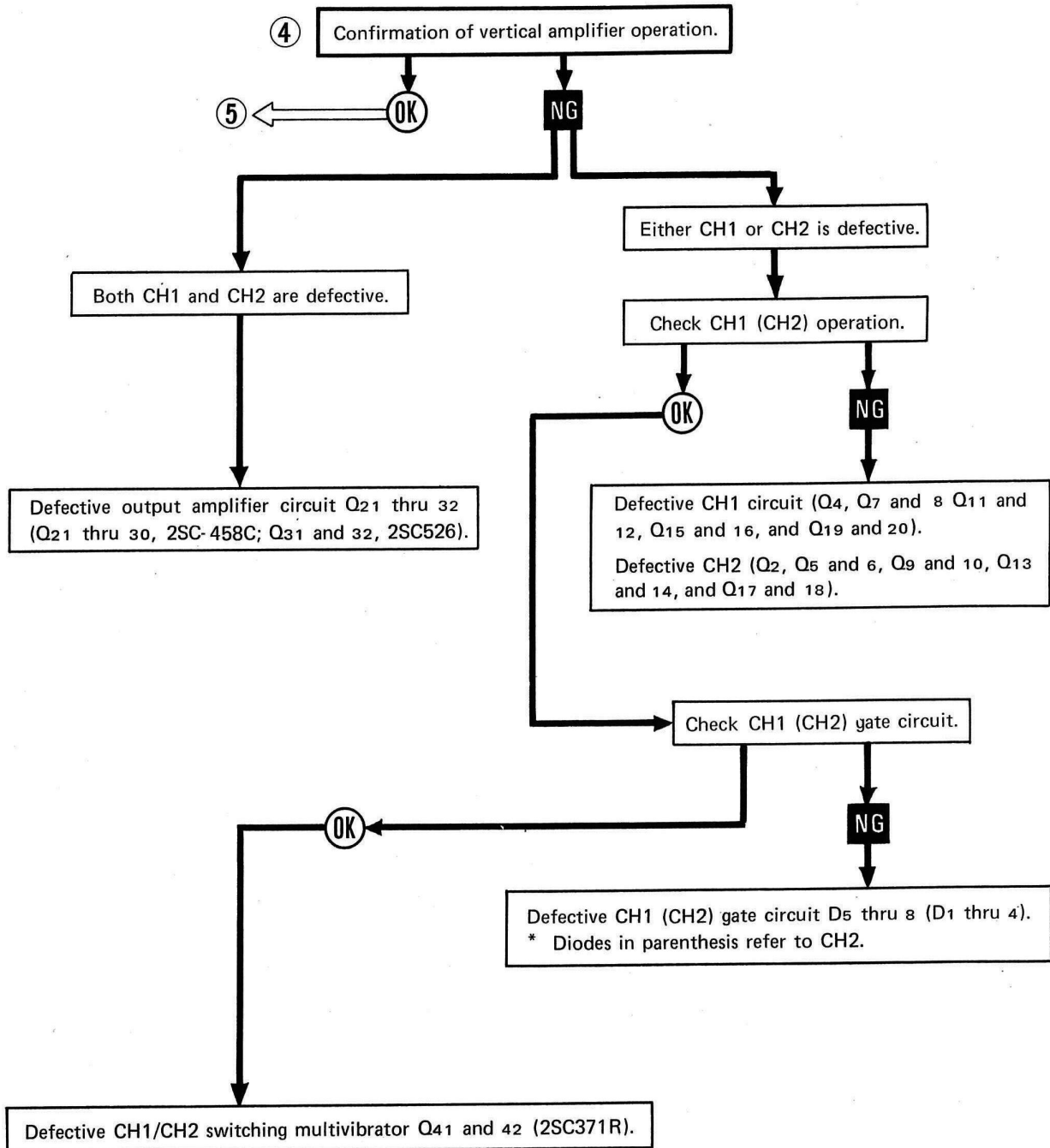

# TROUBLE SHOOTING



NOTE: All components are located on printed circuit board X73-0011-00 unless otherwise noted.

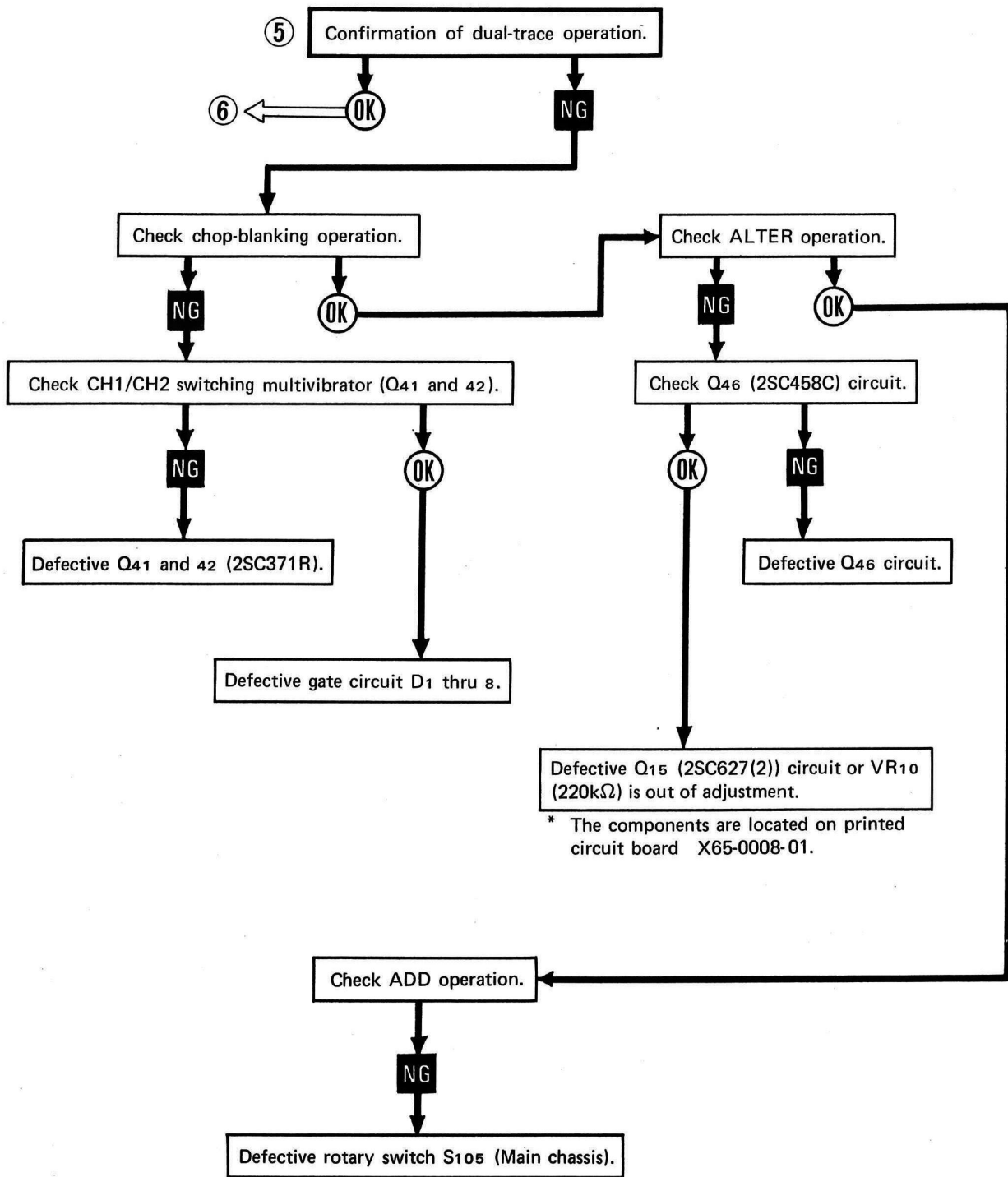



# TROUBLE SHOOTING

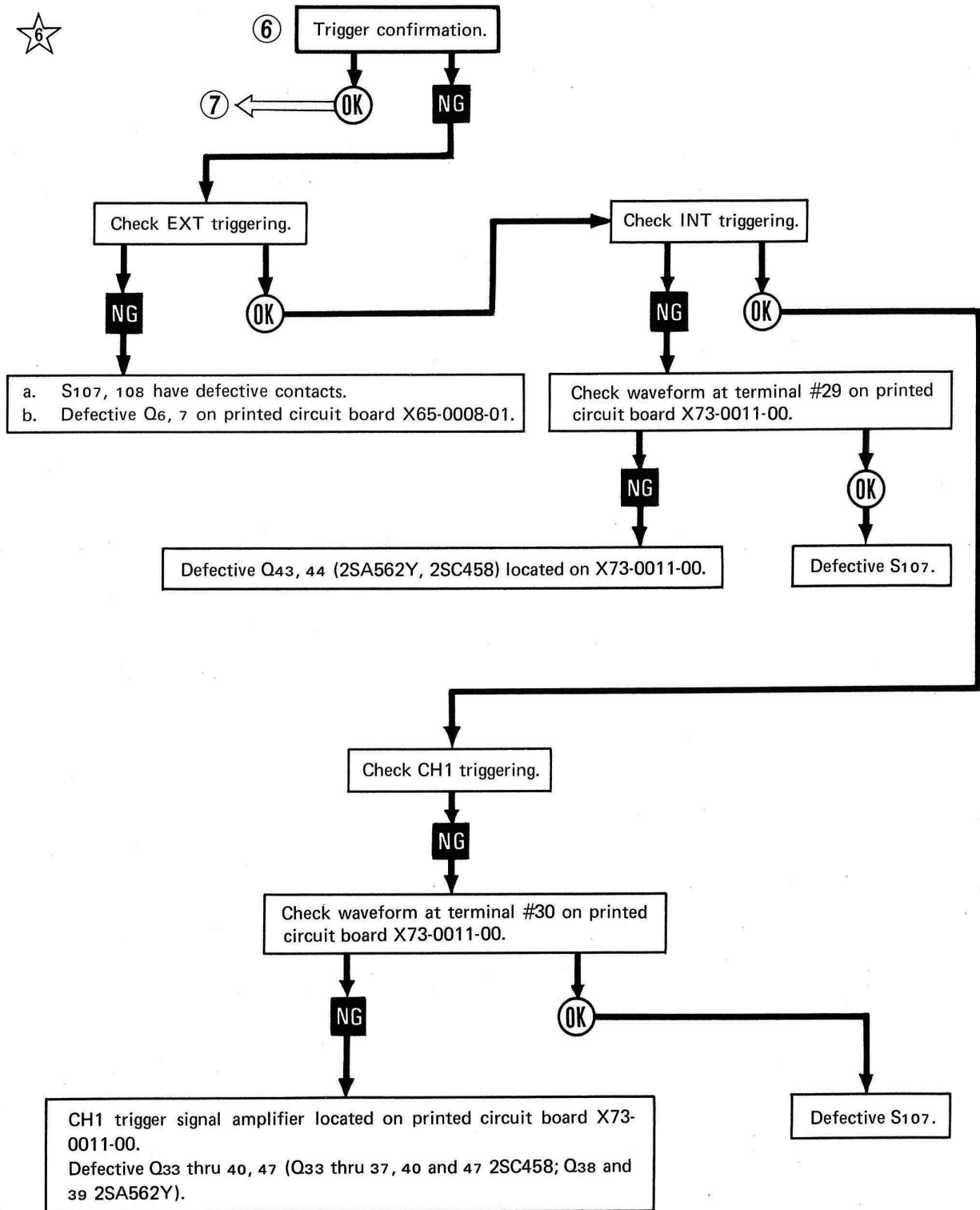

# TROUBLE SHOOTING

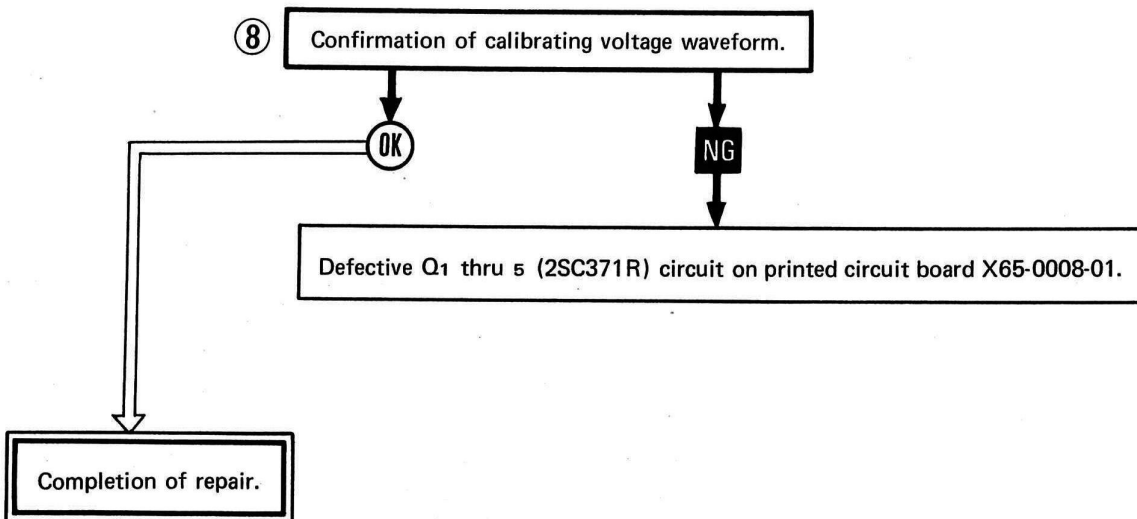
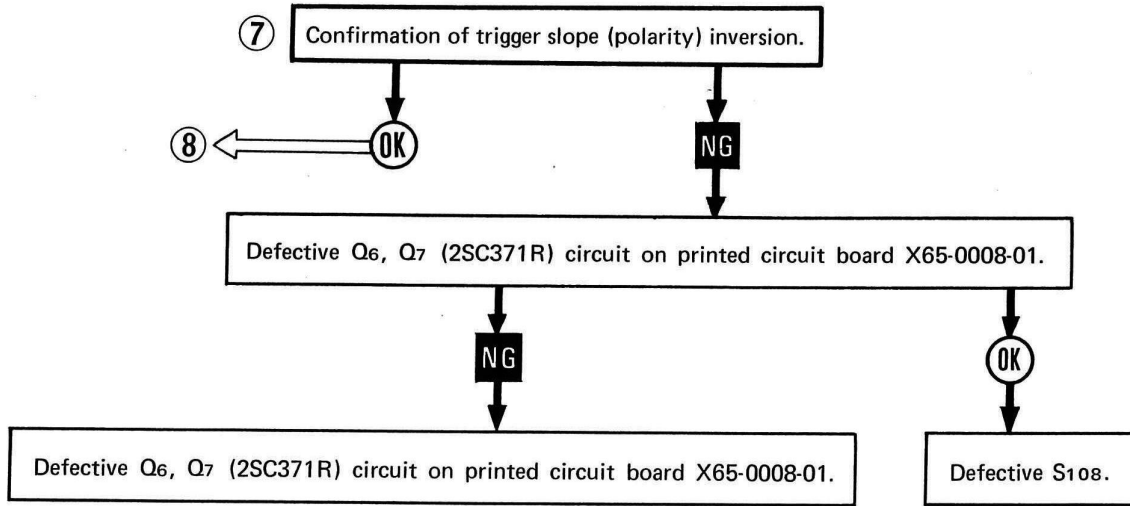

# VOLTAGE WAVEFORMS AT INDIVIDUAL POINTS OF CIRCUIT

Measuring conditions: Input signal 1 kHz wave 1V  
SWEEP TIME 0.1mS/CM

## (1) WAVEFORMS OF SQUARE WAVE SHAPER CIRCUIT

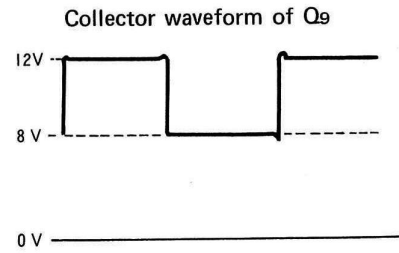
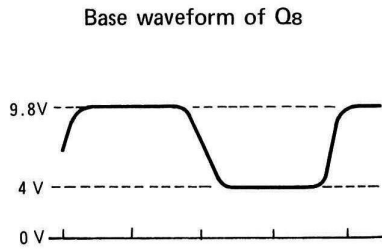

## (2) WAVEFORMS OF GATE MULTIVIBRATOR

\* Q<sub>10</sub> thru 13 (Q<sub>10</sub>, 3SK22GR, Q<sub>11</sub> thru 13, 2SC371R) located on printed circuit board X65-0008-01.

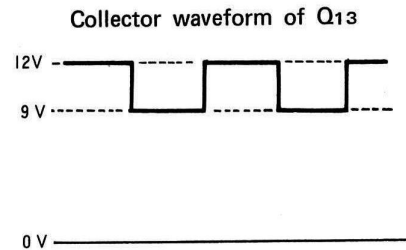
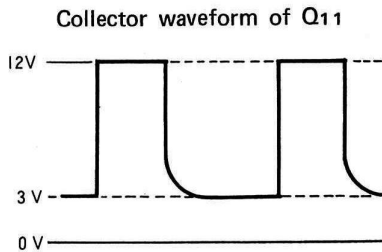
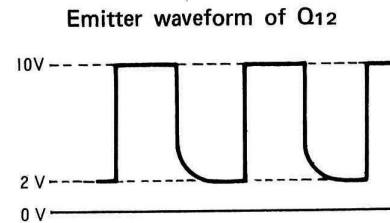
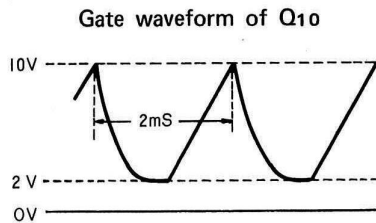

## VOLTAGE WAVEFORMS AT INDIVIDUAL POINTS OF CIRCUIT

### (3) MILLER INTEGRATOR CIRCUIT

\* Q17 thru 20 (Q17, 2SK30 (0); Q18 thru 20, 2SC371R) located on printed circuit board X65-0008-01.

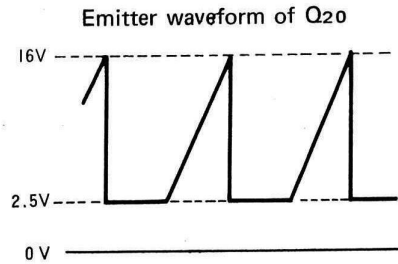
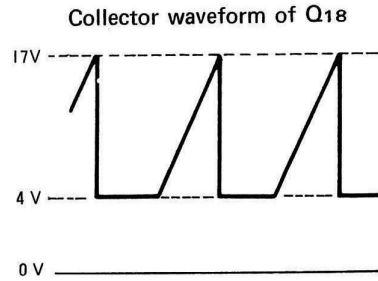
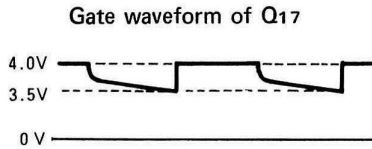

### (4) WAVEFORMS OF HOLD-OFF CIRCUIT

\* Q14 (2SC371R) located on printed circuit board X65-0008-01.

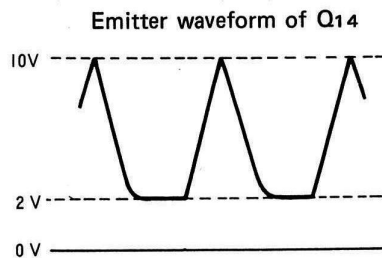
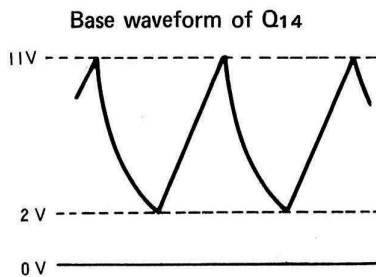

# ADJUSTMENT POINTS ON PC BOARD

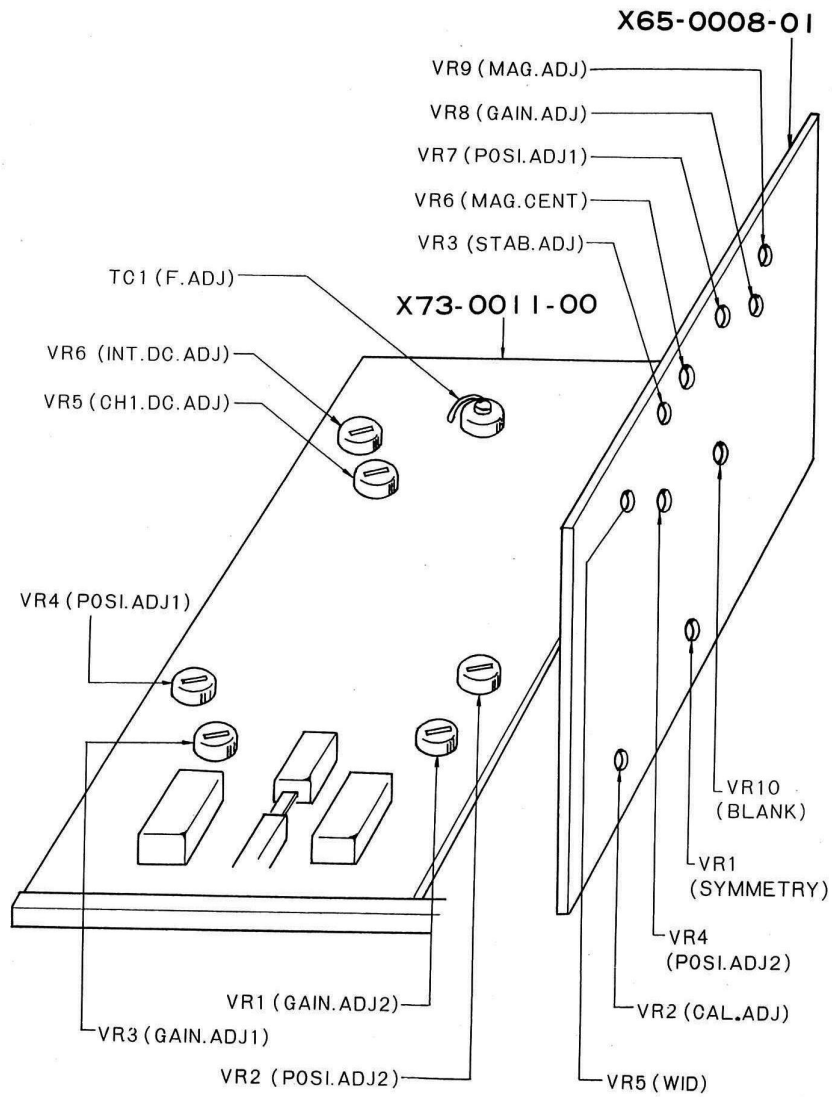

# ADJUSTMENT

- NOTE: \*
- \* This instrument has been factory adjusted for the following adjustments. If re-adjustment is needed, it should be completed only after calibrating the power source voltage.
  - \* Controls surrounded by bold line square are made on the panel.
  - \* Figure (4) is an identification number appearing in the section of EXTERNAL VIEWS, CONTROLS AND CONNECTORS ON PANELS.

## 1. ASTIGMATISM AND FOCUS ADJUSTMENTS

SWEEP TIME/CM (4) . . . . .	EXT
DC-GND-AC ( (16) (17) ) . . . . .	GND
INTENSITY (25) . . . . .	max.

Adjust ASTIG (35) so that the bright spot becomes smallest and circular when FOCUS (24) is turned from min. to max. Then confirm that the bright spot changes in the order of

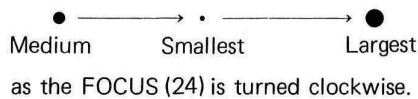

Conduct the following adjustments with INTENSITY (25) set to the position shown on the left.  
 3 o'clock position

## 2. BLANKING ADJUSTMENT

Apply 100 kHz sine wave to VERT INPUT 1 (21), and adjust VR10 (BLANK ADJ) located on printed circuit board X65-0008-01 so that portion A indicated becomes dark.

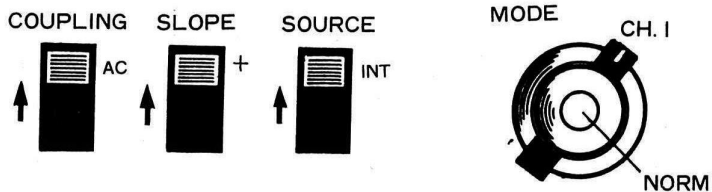
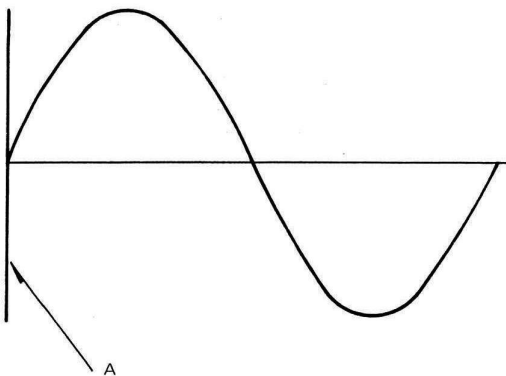

Adjustments and confirmations may be made with MODE (22) set to CH1. Set SOURCE (1), SLOPE (2), COUPLING (3) and CH2 POLARITY (23) to the positions shown below.

# ADJUSTMENT

## 3. DC BAL ADJUSTMENT

Note: Numbers in parenthesis refer to CH2.

MODE (22) ..... CH1 (CH2)

Set DC-GND-AC (17) ( (16) ) to GND.

Turn the vertical attenuator, VARIABLE (15) ( (13) ), to the minimum. Align the trace to the center of the scale by turning CH1  $\blacklozenge$  POSITION (11) ( (10) ). Turn VARIABLE (15) ( (13) ) to the maximum and, if the trace moves accordingly, re-align the trace to the center using DC BAL provided inside the CH1  $\blacklozenge$  POSITION (11) ( (10) ) knob. Repeat the above controls for two to three times until the trace is no longer affected by use of VARIABLE (15) ( (13) ).

## 4. VERTICAL POSITION ADJUSTMENT

Set CH1  $\blacklozenge$  POSITION (11) ( (10) ) knob to the mechanical center and then the trace to the center of the scale using VR4 (VR2) on printed circuit board X73-0011-00.

## 5. VERTICAL SENSITIVITY ADJUSTMENT

CH1 VOLTAGE/CM (14) ( (12) ) ..... .01  
CH2 VARIABLE (15) ( (13) ) ..... max.

Apply 0.04 Vpp square wave to VERT INPUT 1 (21) ( (19) ). Adjust VR3 (VR1) on printed circuit board X73-0011-00 so that the vertical deflection is 40 mm.

NOTE: When utilizing the square wave output from CAL (28) :

CH1 VOLTAGE/CM (14) ( (12) ) ..... .2  
CH1 VARIABLE (15) ( (13) ) ..... max. (CAL)

Connect CAL 1V connector (28) to VERT INPUT 1 (21) ( (19) ). Adjust VR3 (VR1) so that the vertical deflection is 50 mm.

# ADJUSTMENT

## 6. VERTICAL ATTENUATOR ADJUSTMENT

Provide a 1 kHz square wave generator for 50mVpp and 100 Vpp outputs and apply the signals to VERT INPUT 1 (21) ( (19) ). Set CH1 VOLTAGE/CM (14) ( (12) ) to .02V/CM and adjust trimmer TC 118 located on ATT printed circuit board inside the cabinet so that the waveform of the resultant square wave is of high quality. Also, conduct the same adjustment on the individual ranges .05V/CM, 1V/CM . . . . . 20V/CM in the procedure listed below.

.02V/CM	TC 118 (108)	1V/CM	TC 114 (104)
.05	TC 112 (110)	2	—
.1	TC 112 (102)	5	—
.2	TC 117 (107)	10	TC 116 (106)
.5	TC 119 (109)	20	—

## 7. PROBE AND INPUT CAPACITANCE ADJUSTMENTS

Set CH1 VOLTAGE/CM (14) ( (12) ) to .01V/CM. Connect the probe to VERT INPUT 1 (21) ( (19) ) connector, apply 1 kHz square wave to the probe tip, and adjust the trimmer in the probe so that the resultant waveform is of high quality. (In this case, the input voltage is attenuated to 1/10 but the input impedance is 10MΩ 15pF.) Then set CH1 VOLTAGE/CM (14) ( (12) ) to .02V/CM and adjust trimmer TC117 on ATT printed circuit board inside the cabinet so that the square wave is of high quality. Also, conduct the same adjustment on the individual ranges 0.05V/CM, .1/CM . . . . . 20V/CM in the procedure listed below.

.02V/CM	TC 117 (107)	1V/CM	TC 113
.05	TC 119 (109)	2	—
.1	TC 111 (101)	5	—
.2	—	10	TC 115
.5	—	20	—

## 8. VERTICAL FREQUENCY RESPONSE

CH1 VOLTAGE/CM (14) ( (12) ) . . . . . .01  
 CH1 VARIABLE (15) ( (13) ) . . . . . max. (CAL)

Apply 100 kHz sine wave to VERT INPUT 1 (21) ( (19) ) and calibrate for a deflection of 60 mm. Then adjust TC1 on printed circuit board X73-0011-00 so that the deflection decrease to 43 mm when the input frequency is changed from 100 kHz to 10 MHz.



# ADJUSTMENT

## 9. STABILITY ADJUSTMENT

TRIG LEVEL (7) . . . . . AUTO

Apply 1 kHz sine wave to VERT INPUT 1 (21), set STABILITY (6) to the position shown in Fig. 1 below, and adjust VR3 on printed circuit board X65-0008-01 so that the waveform disappears. Then check that the waveform becomes steady in the position of Fig. 2.



Fig. 1

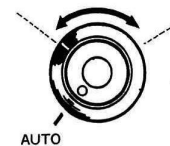
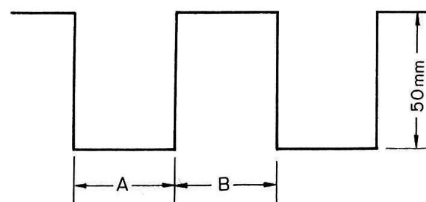

Fig. 2

## 10. CALIBRATION VOLTAGE ADJUSTMENT

CH1 VOLTAGE/CM (14) . . . . . .2  
CH1 VARIABLE (15) . . . . . max. (CAL)

Connect VERT INPUT 1 (21) to 1Vpp of CAL (28), and adjust VR2 on printed circuit board X65-0008-01 so that the deflection is 50 mm. Then adjust VR1 on printed circuit board X65-0008-01 so that lengths A and B equal as shown below.



## 11. SWEEP RATE AND HORIZONTAL SWEEP SPAN ADJUSTMENTS

SWEEP TIME/CM (4) . . . . . .1mS  
VARIABLE/HOR GAIN (5) . . . . . max. (CAL)  
MODE (22) . . . . . CH1

Apply calibrated 1 kHz sine wave to VERT INPUT 1 (21), adjust the individual POSITION controls so that the starting point of the waveform is positioned at the left end of the scale and in the vertical center. Also adjust VR8 on printed circuit board X65-0008-01 so that one wavelength of the wave is 100 mm on the CRT scale. With this adjustment, since the length of the trace will change, adjust the length to 105 mm using VR5 on the same printed circuit board. For ranges of from 10μS to 0.5μS/cm, the input frequency should be adjusted not with VR8, VR5 but with the trimmers attached to the SWEEP TIME rotary switch, as listed below.

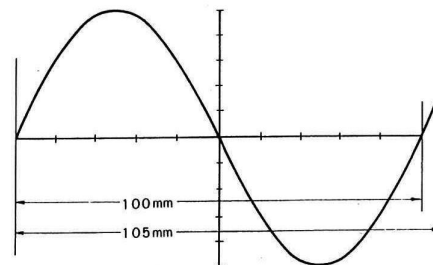

SWEEP TIME/CM	Input frequency	Trimmer to be adjusted
10μS/cm	10 kHz	TC 121
1μS/cm	100 kHz	TC 122
0.5μS/cm	200 kHz	TC 123

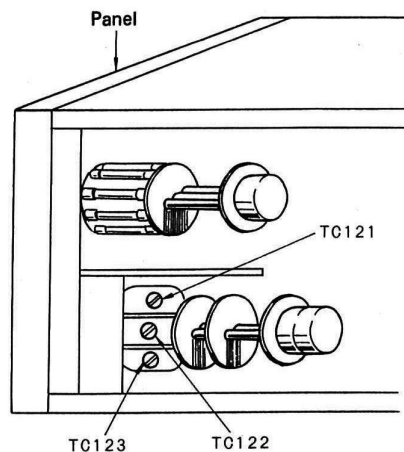

# ADJUSTMENT

## 12. SWEEP MAGNIFICATION ADJUSTMENT

SWEEP TIME/CM (4) . . . . . 1mS

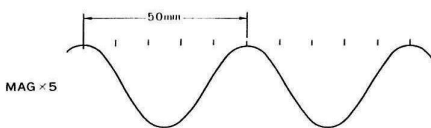
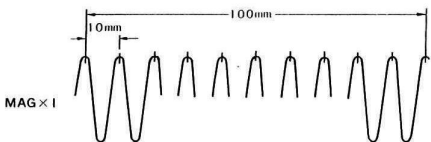

### 1) MAG X5 ADJUSTMENT

Apply 1 kHz (approximately) sine wave to VERT INPUT 1 (21), adjust the generator frequency and POSITION (9) to obtain 11 peaks of the waveform and to place each of these peaks on each vertical graticule line.

Adjust VR9 on printed circuit board X65-0008-01 so that distance from one peak to another is 50 mm when MAG X5 (9) is set to "X5"

### 2) MAG CENTER ADJUSTMENT

SWEEP TIME/CM (4) . . . . . 1mS

Apply 1 kHz square wave to VERT INPUT 1 (21) and adjust so that one cycle of the waveform lies extending from the first to last vertical graticule line. Set POSITION (9) to the mechanical center and MAG X-5 (9) to "X5", and adjust VR6 on printed circuit board X65-0008-01 so that the rising (or falling) point in the center of the waveform coincides with that obtained with the normal position of the MAG X5 switch.

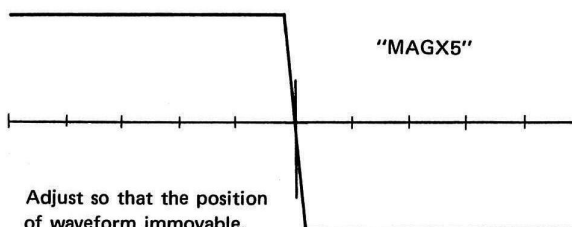
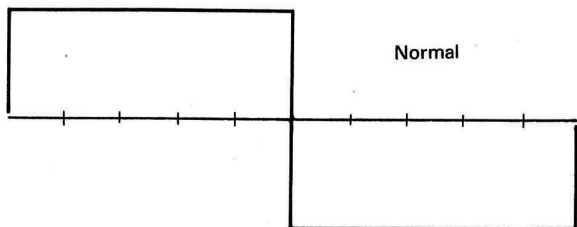

# ADJUSTMENT

## 13. HORIZONTAL POSITION ADJUSTMENT (1)

POSITION (9) . . . . . Mechanical center
--

Place the starting point of the waveform on the left end of the scale using VR7 on printed circuit board X65-0008-1.

## 14. HORIZONTAL POSITION ADJUSTMENT (2)

SWEEP TIME/CM (4) . . . . . EXT
POSITION (9) . . . . . Mechanical center

After completion of "13. HORIZONTAL POSITION ADJUSTMENT (1)", position the spot at the midpoint of the scale using VR4 on the same printed circuit board.

## 15. TRIG LEVEL ADJUSTMENT

\* This adjustment should be carried out with TRIG LEVEL (7) set not to AUTO but by triggering with TRIG LEVEL (7).

MODE (22) . . . . . CH1
SOURCE (1) . . . . . INT

### 1) INT DC LEVEL ADJUSTMENT

Apply 1 kHz sine wave to VERT INPUT 1 (21) and adjust VR6 on printed circuit board X73-0011-00 so that the starting point may not move when COUPLING (3) is switched between AC and DC.

### 2) CH1 DC LEVEL ADJUSTMENT

Adjust VR5 on printed circuit board X73-0011-00 in the same way1).

# PARTS LAYOUT(FRONT VIEW)

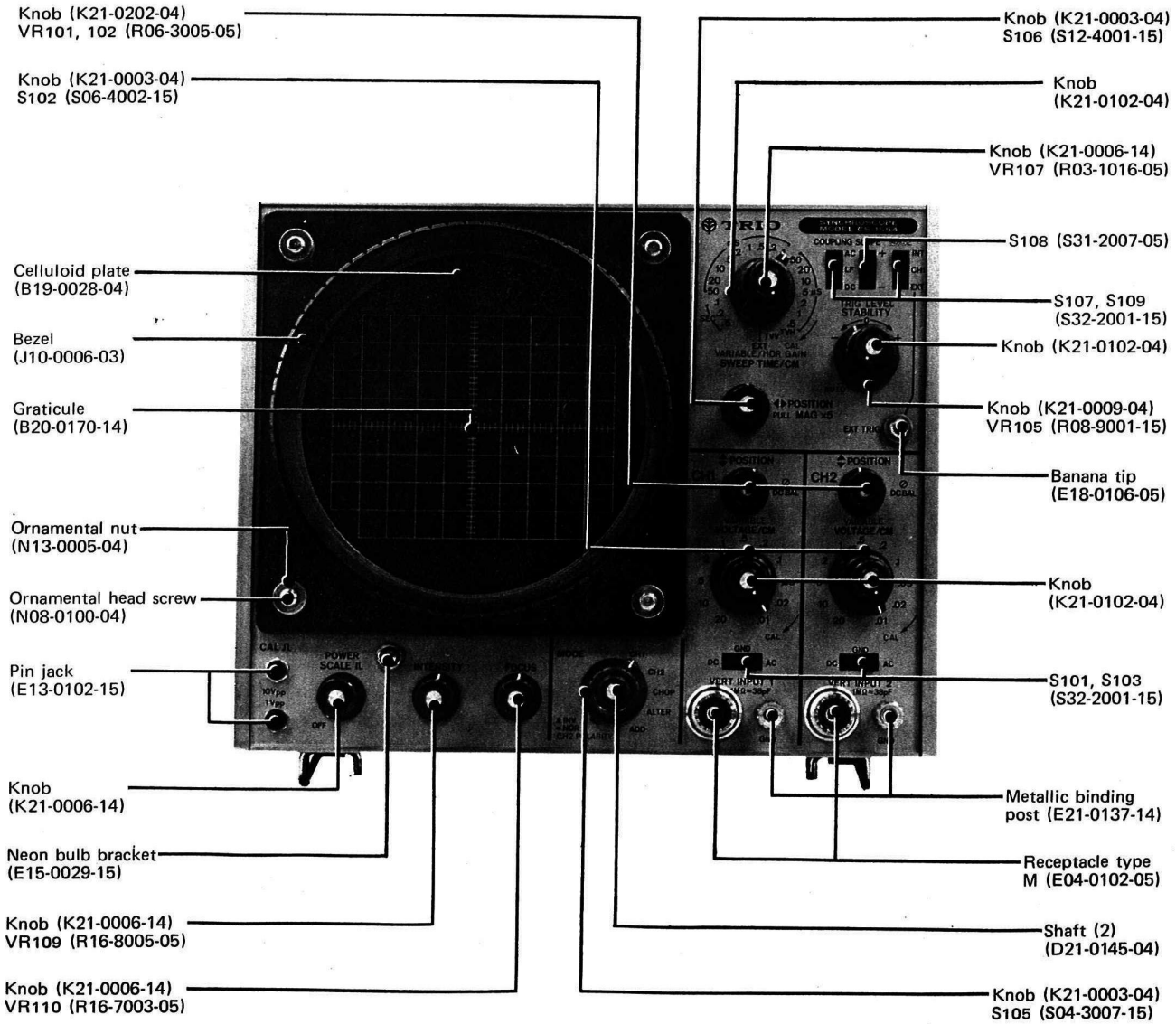

# PARTS LAYOUT (REAR VIEW)

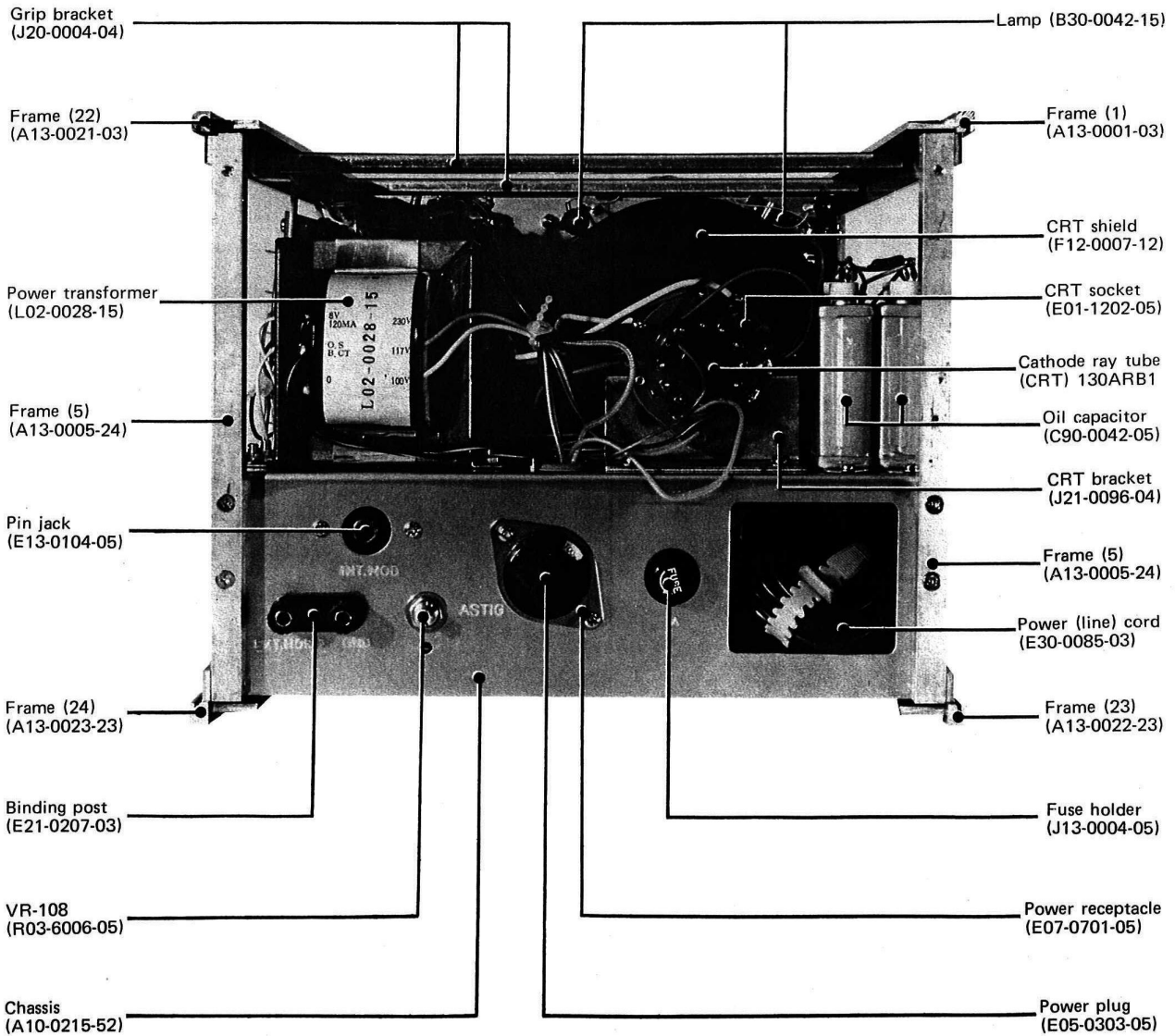

# PARTS LAYOUT (TOP VIEW)

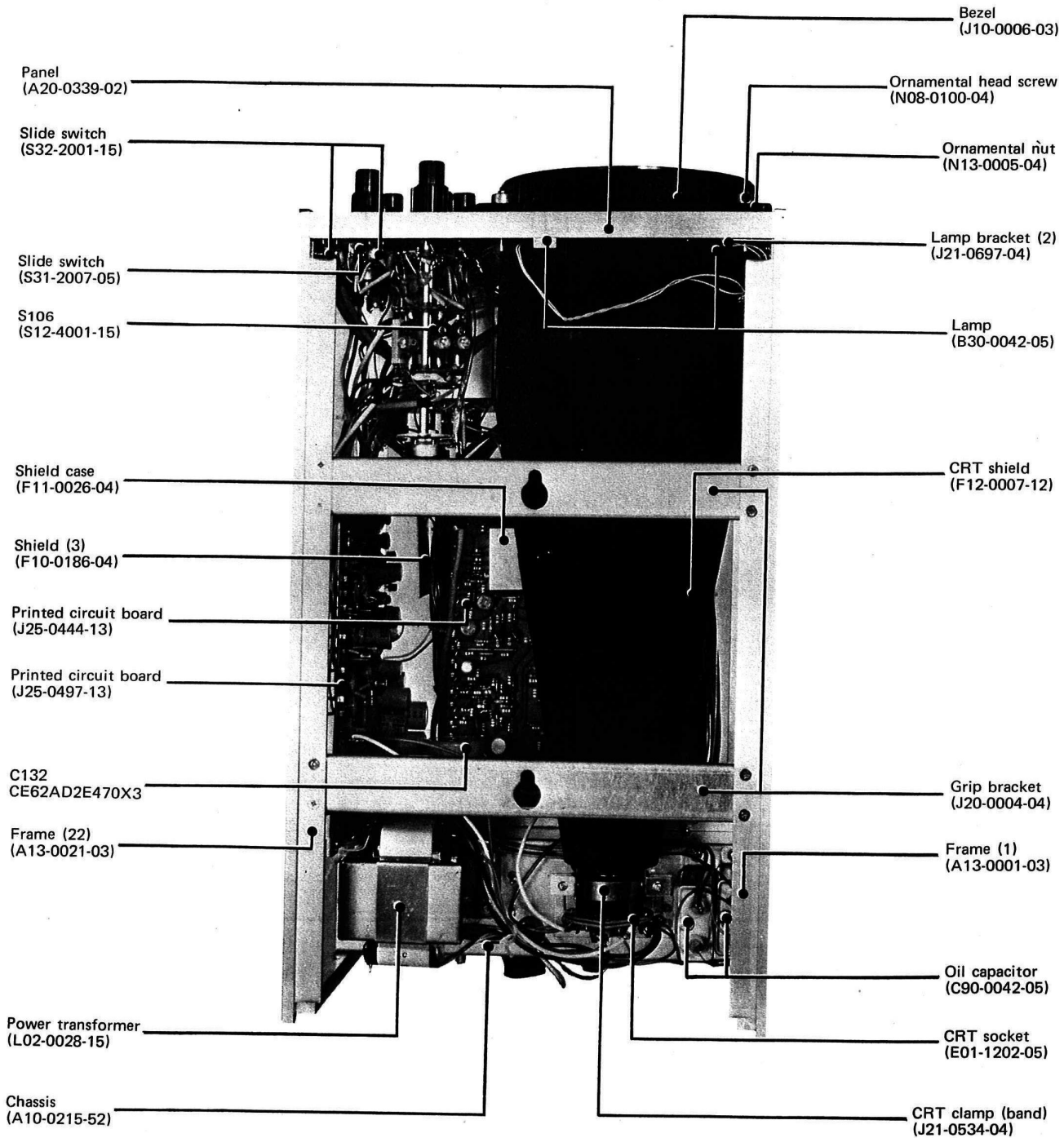

# PARTS LAYOUT (SIDE VIEW)

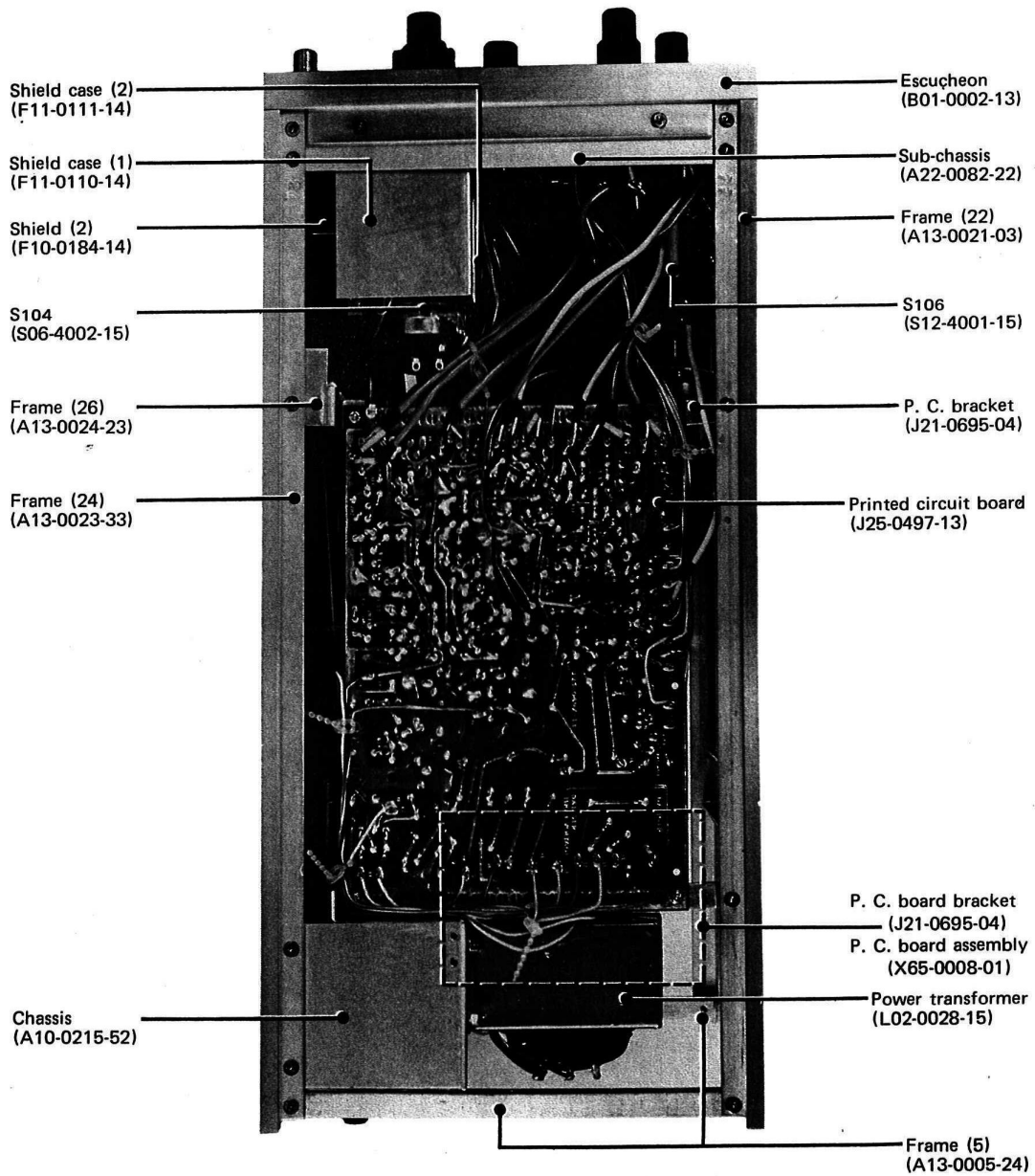

# PARTS LAYOUT (BOTTOM VIEW)

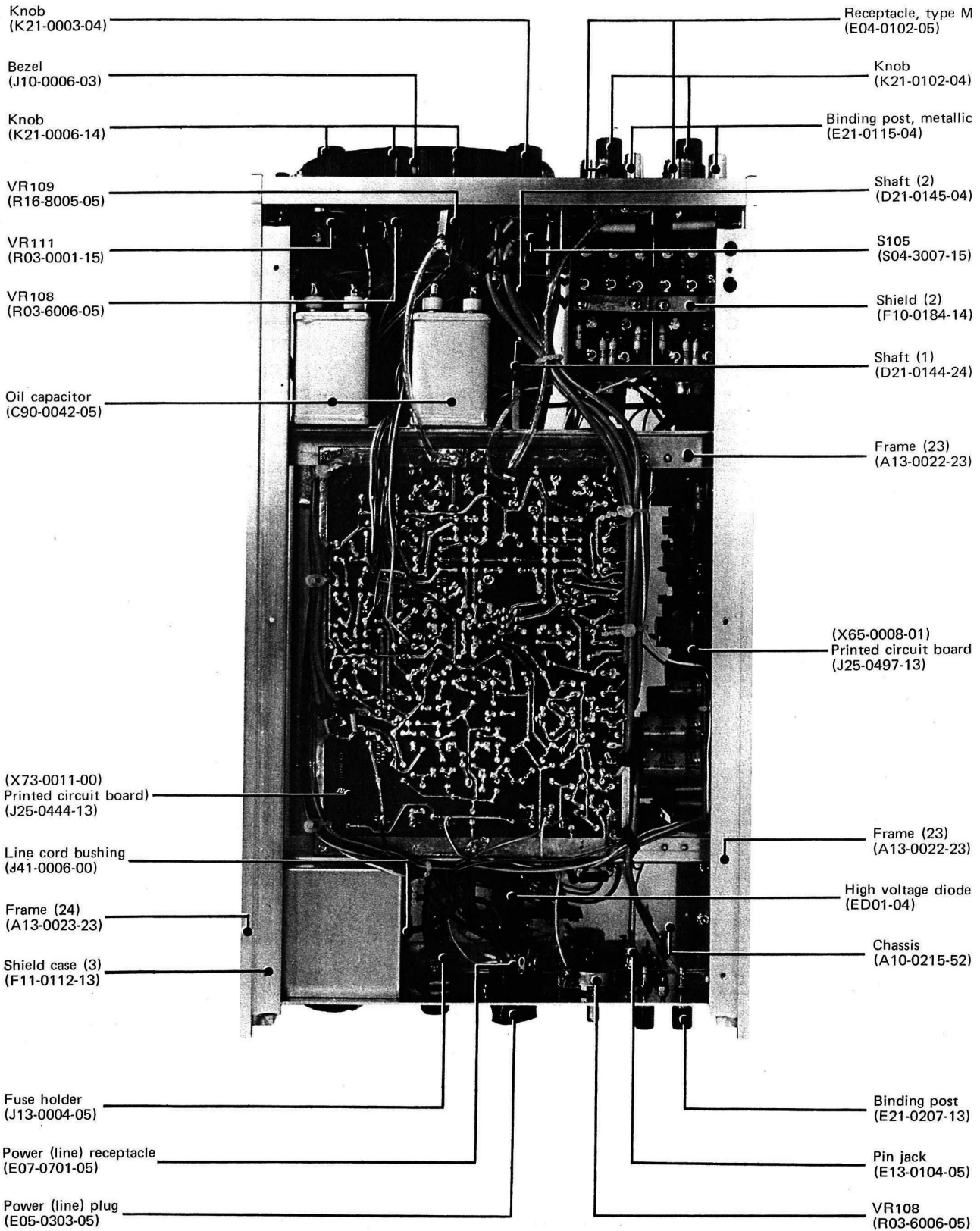



## PARTS LIST OF CS-1554

Circuit No.	Parts No.	Description	Remarks
—	A10-0215-52	Chassis	
—	A13-0001-03	Frame (1)	
—	A13-0005-24	Frame (5)	
—	A13-0021-03	Frame (22)	
—	A13-0022-23	Frame (23)	
—	A13-0023-33	Frame (24)	
—	A13-0024-23	Frame (26)	
—	A20-0339-02	Panel	
—	A22-0082-22	Sub-chassis	
—	A40-0061-03	Bottom plate	
—	A48-0003-13	Side plate	
—	A52-0002-23	Top plate	
—	B01-0002-13	Escucheon	
—	B19-0028-04	Celluloid plate	
—	B20-0170-14	Graticule	
—	B30-0042-15	Lamp	
—	B40-0332-14	Name plate	
—	B42-0009-04	Passed sticker	
—	B48-0049-00	Label	
—	B50-0589-00	Instruction manual	
—	D21-0144-24	Shaft (1)	
—	D21-0145-04	Shaft (2)	
—	E01-1202-05	CRT socket	
—	E04-0102-05	Receptacle type M	
—	E05-0303-05	Power (line) plug	
—	E07-0701-05	Power (line) receptacle	
—	E13-0102-15	Pin jack	
—	E13-0104-05	Pin jack	
—	E14-0101-05	Pin plug	
—	E15-0029-15	Neon bulb bracket	
—	E18-0106-05	Banana tip receptacle	
—	E21-0137-14	Metallic binding post	
—	E21-0207-13	Binding post	
—	E22-0206-05	Lug board	
—	E22-0404-05	Lug board	
—	E23-0015-04	Ground lug	
—	E23-0017-04	Ground lug	
—	E23-0042-00	Soldering lug	
—	E30-0085-03	Power (line) cord with plug (CA36)	
—	F05-5013-05	Fuse	
—	F10-0183-04	Shield (1)	
—	F10-0184-04	Shield (2)	
—	F10-0186-04	Shield (3)	
—	F11-0110-14	Shield case (1)	
—	F11-0111-14	Shield case (2)	
—	F11-0112-23	Shield case (3)	
—	F12-0007-12	CRT shield	
—	F14-0007-04	Soft tape	

## PARTS LIST OF CS-1554

Circuit No.	Parts No.	Description	Remarks
—	F20-0029-04	Insulator	
—	F20-0045-04	Insulator	
—	G01-0186-04	Spring	
—	G13-0038-00	Cushion	
—	H01-0498-03	Packing case	
—	H10-0023-04	Protection board	
—	H10-0611-03	Packing material, foamed styrene	
—	H20-0006-03	Protection cover	
—	H25-0003-03	Protection bag	
—	H25-0029-04	Polyethylene bag	
—	J01-0013-13	Metallic leg	
—	J02-0008-03	Molded leg	
—	J10-0006-03	Bezel	
—	J13-0004-05	Fuse holder	
—	J20-0004-04	Grip bracket	
—	J21-0040-04	Grip bracket (2)	
—	J21-0096-04	CRT bracket	
—	J21-0695-04	PC board bracket	
—	J21-0696-04	Lamp bracket (1)	
—	J21-0697-04	Lamp bracket (2)	
—	J25-0443-14	Printed circuit board	
—	J30-0071-04	Spacer	
—	J41-0006-00	Power (line) cord bushing	
—	J42-0009-04	Rubber bushing	
—	J42-0010-04	Rubber bushing	
—	K01-0029-04	Grip	
—	K01-0036-03	Grip bracket	
—	L02-0028-25	Power transformer	
—	X65-0008-01	Horizontal amplifier unit	
—	X73-0011-00	Vertical amplifier unit	
—	Y87-0013-01	Probe (PC-12)	
—		Cathode ray tube 130 ARB1	
<b>SWITCH</b>			
S101	S32-2001-15	Slide switch	
S102a~d	S06-4002-15	Rotary switch (VR103)	
S103	S32-2001-15	Slide switch	
S104a~d	S06-4002-15	Rotary switch (VR104)	
S105a~e	S04-3007-15	Rotary switch	
S106a~h	S12-4001-15	Rotary switch (VR106a, b)	
S107	S32-2001-15	Slide switch	
S108	S31-2007-05	Slide switch	
S109	S32-2001-15	Slide switch	
S110a, b	R08-9001-15	Variable resistor (VR105 a, b)	

## PARTS LIST OF CS-1554

Circuit No.	Parts No.	Description	Remarks
S111	R03-1016-05	Variable resistor (VR107)	
S112	R03-0001-15	Variable resistor (VR111)	
<b>KNOB</b>			
—	K21-0003-04	Knob	
—	K21-0006-14	Knob	
—	K21-0009-04	Knob	
—	K21-0102-04	Knob	
—	K21-0202-04	Knob	
<b>DIODE</b>			
D101,102		High voltage diode (ED01-04)	
D103, 104		Diode (8-05-08)	
<b>POTENTIOMETER</b>			
VR101a, b	R06-3005-05	Variable resistor	
VR102a, b	R06-3005-05	Variable resistor	
VR103	S06-4002-15	Rotary switch (S102a~d)	
VR104	S06-4002-15	Rotary switch (S104a~d)	
VR105a, b	R08-9001-15	Variable resistor 100k $\Omega$ (B), 5k $\Omega$ (B)	
VR106a, b	S12-4001-15	Rotary switch (S106a~b) 5k $\Omega$ (B) 100k $\Omega$ (B)	
VR107	R03-1016-05	Variable resistor (S111) 2k $\Omega$ (B)	
VR108	R03-6006-05	Variable resistor 250k $\Omega$ (B)	
VR109	R16-8005-05	Variable resistor 1M $\Omega$ (B)	
VR110	R16-7003-05	Variable resistor 500k $\Omega$ (B)	
VR111	R03-0001-15	Variable resistor (S112) 100 $\Omega$ (B)	
<b>RESISTOR</b>			
R101, 102	PD14BY2E470J	Insulated carbon film	47 $\Omega$ $\pm$ 5% 1/4W
R103	PD14BY2H904F	Insulated carbon film	900k $\Omega$ $\pm$ 1% 1/2W
R104	PD14BY2H1113F	Insulated carbon film	111k $\Omega$ $\pm$ 1% 1/2W
R105	PD14BY2H994F	Insulated carbon film	990k $\Omega$ $\pm$ 1% 1/2W
R106	PD14BY2H1012F	Insulated carbon film	10.1k $\Omega$ $\pm$ 1% 1/2W
R107	PD14BY2H9993F	Insulated carbon film	999k $\Omega$ $\pm$ 1% 1/2W
R108	PD14BY2H102F	Insulated carbon film	1k $\Omega$ $\pm$ 1% 1/2W
R109	PD14BY2H504F	Insulated carbon film	500k $\Omega$ $\pm$ 1% 1/2W
R110	PD14BY2H105F	Insulated carbon film	1M $\Omega$ $\pm$ 1% 1/2W
R111	PD14BY2H804F	Insulated carbon film	800k $\Omega$ $\pm$ 1% 1/2W
R112	PD14BY2H254F	Insulated carbon film	250k $\Omega$ $\pm$ 1% 1/2W
R113	PD14BY2H904F	Insulated carbon film	900k $\Omega$ $\pm$ 1% 1/2W
R114	PD14BY2H1113F	Insulated carbon film	111k $\Omega$ $\pm$ 1% 1/2W
R115	PD14BY2H994F	Insulated carbon film	990k $\Omega$ $\pm$ 1% 1/2W
R116	PD14BY2H1012F	Insulated carbon film	10.1k $\Omega$ $\pm$ 1% 1/2W
R117	PD14BY2H9993F	Insulated carbon film	999k $\Omega$ $\pm$ 1% 1/2W
R118	PD14BY2H102F	Insulated carbon film	1k $\Omega$ $\pm$ 1% 1/2W
R119	PD14BY2H504F	Insulated carbon film	500k $\Omega$ $\pm$ 1% 1/2W
R120	PD14BY2H105F	Insulated carbon film	1M $\Omega$ $\pm$ 1% 1/2W
R121	PD14BY2H804F	Insulated carbon film	800k $\Omega$ $\pm$ 1% 1/2W
R122	PD14BY2H254F	Insulated carbon film	250k $\Omega$ $\pm$ 1% 1/2W
R123	PD14BY2E104J	Insulated carbon film	100k $\Omega$ $\pm$ 5% 1/4W
R124	PD14BY2E153J	Insulated carbon film	15k $\Omega$ $\pm$ 5% 1/4W
R125	PD14BY2H305F	Insulated carbon film	3M $\Omega$ $\pm$ 1% 1/2W

## PARTS LIST OF CS-1554

Circuit No.	Parts No.	Description				Remarks
R126, 127	PD14BY2H105F	Insulated acarbon film	1M $\Omega$	$\pm 1\%$	1/2W	
R128	PD14BY2E272J	Insulated carbon film	2.7k $\Omega$	$\pm 5\%$	1/4W	
R129	PD14BY2E333J	Insulated carbon film	33k $\Omega$	$\pm 5\%$	1/4W	
R131	R92-0054-25	SC resistor	2.2M $\Omega$	$\pm 5\%$	1W	
R132	PD14BY2H134J	Insulated carbon film	130k $\Omega$	$\pm 5\%$	1/2W	
R134	RN14AA3A681J	Metal film	680 $\Omega$	$\pm 5\%$	1W	
R135	RN14AA3A391J	Metal film	390 $\Omega$	$\pm 5\%$	1W	
R136	PD14BY2E104J	Insulated carbon film	100k $\Omega$	$\pm 5\%$	1/4W	
R137	PD14BY2E470J	Insulated carbon film	47 $\Omega$	$\pm 5\%$	1/4W	
<b>CAPACITOR</b>						
C101, 102	C90-0021-05	Metalized film	0.1 $\mu$ F	$\pm 20\%$	600V	
C103	CQ08S2B330J	Polystyrene	33pF	$\pm 5\%$	125V	
C104	CQ08S1H331J	Polystyrene	330pF	$\pm 5\%$	50V	
C105	CQ05S1H332J	Polystyrene	3300pF	$\pm 5\%$	50V	
C106	CQ08S2B330J	Polystyrene	33pF	$\pm 5\%$	125V	
C107	CQ08S1H331J	Polystyrene	330pF	$\pm 5\%$	50V	
C108	CQ05S1H332J	Polystyrene	3300pF	$\pm 5\%$	50V	
C109	CC94SL2H150J	Ceramic	15pF	$\pm 5\%$	500V	
C110	CE04D1H010N	Non-polarized electrolytic	1 $\mu$ F		50V	
C111	CQ93M1H153M	Mylar	0.015 $\mu$ F	$\pm 20\%$	50V	
C112	CE04D1H010N	Non-polarized electrolytic	1 $\mu$ F		50V	
C113	C90-0018-05	Metalized film	1 $\mu$ F	$\pm 1\%$	200V	
C114	C90-0019-05	Metalized film	0.1 $\mu$ F	$\pm 1\%$	200V	
C115	C90-0020-05	Metalized film	0.01 $\mu$ F	$\pm 1\%$	200V	
C116	CM91D2H1Q2F	Mica	0.001 $\mu$ F	$\pm 1\%$	500V	
C117	CM91D2H900J	Mica	90pF	$\pm 5\%$	500V	
C118	CC94SL2H121J	Ceramic	120pF	$\pm 5\%$	500V	
C119	CQ93M1H333K	Mylar	0.033 $\mu$ F	$\pm 10\%$	50V	
C120	CQ93M1H224K	Mylar	0.22 $\mu$ F	$\pm 10\%$	50V	
C121	CK94YY2H223M	Ceramic	0.022 $\mu$ F	$\pm 20\%$	500V	
C122	CK94YY2H222M	Ceramic	0.0022 $\mu$ F	$\pm 20\%$	500V	
C123	CK94YY2H102M	Ceramic	0.001 $\mu$ F	$\pm 20\%$	500V	
C124	CC94SL2H101J	Ceramic	100pF	$\pm 5\%$	500V	
C125	CC94SL2H100J	Ceramic	10pF	$\pm 5\%$	500V	
C126	CC94SL2H101J	Ceramic	100pF	$\pm 5\%$	500V	
C127	CK94YY2H103M	Ceramic	0.01 $\mu$ F	$\pm 20\%$	500V	
C128~131	C90-0042-05	Oil	0.5 $\mu$ F	$\pm 10\%$	1.5kV	
C132a~c	CE62AD2E470	Electrolytic block	47 $\mu$ F		250V	
C133	CM91D3C120K	Mica	12pF	$\pm 10\%$	1.6kV	
C134	CQ93M1H223M	Mylar	0.022 $\mu$ F	$\pm 20\%$	50V	
C135	CP02B2J104K	Oil	0.1 $\mu$ F	$\pm 10\%$	630V	
TC101	C05-0015-15	Ceramic trimmer	40pF			
TC102	C05-0010-15	Ceramic trimmer	10pF			
TC103	C05-0015-15	Ceramic trimmer	40pF			
TC104	C05-0010-15	Ceramic trimmer	10pF			
TC105	C05-0015-15	Ceramic trimmer	40pF			
TC106, 107	C05-0010-15	Ceramic trimmer	10pF			
TC108	C05-0015-15	Ceramic trimmer	40pF			
TC109, 110	C05-0013-15	Ceramic trimmer	20pF			
TC111	C05-0015-15	Ceramic trimmer	40pF			

## PARTS LIST OF CS-1554

Circuit No.	Parts No.	Description	Remarks
TC112	C05-0010-15	Ceramic trimmer	10pF
TC113	C05-0015-15	Ceramic trimmer	40pF
TC114	C05-0010-15	Ceramic trimmer	10pF
TC115	C05-0015-15	Ceramic trimmer	40pF
TC116, 117	C05-0010-15	Ceramic trimmer	10pF
TC118	C05-0015-15	Ceramic trimmer	40pF
TC119, 120	C05-0013-15	Ceramic trimmer	20pF
TC121~123	C05-0011-05	Ceramic trimmer	10pF

## PARTS LIST OF X65-0008-01

Circuit No.	Parts No.	Description	Remarks
—	J25-0497-23	PC board	
<b>SEMICONDUCTOR</b>			
Q1~9 Q10 Q11~14 Q15 Q16 Q17 Q18~21 Q22~24  D1 D2 D3 D4, 5 D6 D7 D8 D9 D10 D11 D12		2SC371 (R) 3SK22 (GR) 2SC371 (R) 2SC627 (2) 2SK19 (Y) 2SK30 (O) 2SC371 (R) 2SC627 (2)  ZB1-6 1S1555 1N60 1S1555 ZB1-12 SZ-200-25 ZB1-6 1S1850 1S1850R 1S1555 10D10	
<b>POTENTIOMETER</b>			
VR1 VR2 VR3 VR4 VR5, 6 VR7, 8 VR9 VR10	R12-5002-05 R12-1004-05 R12-3004-05 R12-5002-05 R12-3002-05 R12-1002-05 R12-0004-05 R12-5018-05	PC trimmer potentiometer 100k $\Omega$ (B) PC trimmer potentiometer 4.7k $\Omega$ (B) PC trimmer potentiometer 47k $\Omega$ (B) PC trimmer potentiometer 100k $\Omega$ (B) PC trimmer potentiometer 10k $\Omega$ (B) PC trimmer potentiometer 1k $\Omega$ (B) PC trimmer potentiometer 330 $\Omega$ (B) PC trimmer potentiometer 220k $\Omega$ (B)	
<b>RESISTOR</b>			
R1 R2, 3 R4 R5 R6 R7 R8 R9 R10 R11 R12 R13 R14 R15 R16 R17 R18	PD14BY2E103J PD14BY2E473J PD14BY2E103J PD14BY2E473J PD14BY2E472J PD14BY2E470J PD14BY2E273J PD14BY2E103J PD14BY2H452F PD14BY2H501F PD14BY2E121J PD14BY2E103J PD14BY2E822J PD14BY2E332J PD14BY2E102J PD14BY2E104J PD14BY2E272J	Insulated carbon film Insulated carbon film Insulated carbon film Insulated carbon film Insulated carbon film Insulated carbon film Insulated carbon film Insulated carbon film Insulated carbon film Insulated carbon film Insulated carbon film Insulated carbon film Insulated carbon film Insulated carbon film Insulated carbon film Insulated carbon film Insulated carbon film Insulated carbon film Insulated carbon film	10k $\Omega$ $\pm 5\%$ 1/4W 47k $\Omega$ $\pm 5\%$ 1/4W 10k $\Omega$ $\pm 5\%$ 1/4W 47k $\Omega$ $\pm 5\%$ 1/4W 4.7k $\Omega$ $\pm 5\%$ 1/4W 47 $\Omega$ $\pm 5\%$ 1/4W 27k $\Omega$ $\pm 5\%$ 1/4W 10k $\Omega$ $\pm 5\%$ 1/4W 4.5k $\Omega$ $\pm 1\%$ 1/2W 500 $\Omega$ $\pm 1\%$ 1/2W 120 $\Omega$ $\pm 5\%$ 1/4W 10k $\Omega$ $\pm 5\%$ 1/4W 8.2k $\Omega$ $\pm 5\%$ 1/4W 3.3k $\Omega$ $\pm 5\%$ 1/4W 10k $\Omega$ $\pm 5\%$ 1/4W 100k $\Omega$ $\pm 5\%$ 1/4W 2.7k $\Omega$ $\pm 5\%$ 1/4W

## PARTS LIST OF X65-0008-01

Circuit No.	Parts No.	Description	Remarks
R19	PD14BY2E392J	Insulated carbon film 3.9kΩ ±5% 1/4W	
R20	PD14BY2E273J	Insulated carbon film 27kΩ ±5% 1/4W	
R21	PD14BY2E103J	Insulated carbon film 10kΩ ±5% 1/4W	
R22	PD14BY2E183J	Insulated carbon film 18kΩ ±5% 1/4W	
R23	PD14BY2E222J	Insulated carbon film 2.2kΩ ±5% 1/4W	
R24	PD14BY2E104J	Insulated carbon film 100kΩ ±5% 1/4W	
R25	PD14BY2E273J	Insulated carbon film 27kΩ ±5% 1/4W	
R26	PD14BY2E222J	Insulated carbon film 2.2kΩ ±5% 1/4W	
R27	PD14BY2E103J	Insulated carbon film 10kΩ ±5% 1/4W	
R28	PD14BY2E182J	Insulated carbon film 1.8kΩ ±5% 1/4W	
R29	PD14BY2E103J	Insulated carbon film 10kΩ ±5% 1/4W	
R30	PD14BY2E272J	Insulated carbon film 2.7kΩ ±5% 1/4W	
R31	PD14BY2E472J	Insulated carbon film 4.7kΩ ±5% 1/4W	
R32	PD14BY2E333J	Insulated carbon film 33kΩ ±5% 1/4W	
R33, 34	PD14BY2E103J	Insulated carbon film 10kΩ ±5% 1/4W	
R35	PD14BY2E821J	Insulated carbon film 820Ω ±5% 1/4W	
R36	PD14BY2E223J	Insulated carbon film 22kΩ ±5% 1/4W	
R38	PD14BY2E822J	Insulated carbon film 8.2kΩ ±5% 1/4W	
R40	PD14BY2E103J	Insulated carbon film 10kΩ ±5% 1/4W	
R41	PD14BY2E183J	Insulated carbon film 18kΩ ±5% 1/4W	
R43	PD14BY2E273J	Insulated carbon film 27kΩ ±5% 1/4W	
R44	PD14BY2E183J	Insulated carbon film 18kΩ ±5% 1/4W	
R45	PD14BY2E752J	Insulated carbon film 7.5kΩ ±5% 1/4W	
R46	PD14BY2E332J	Insulated carbon film 3.3kΩ ±5% 1/4W	
R47	PD14BY2E105J	Insulated carbon film 1MΩ ±5% 1/4W	
R48	PD14BY2E182J	Insulated carbon film 1.8kΩ ±5% 1/4W	
R49	PD14BY2E103J	Insulated carbon film 10kΩ ±5% 1/4W	
R50	PD14BY2E153J	Insulated carbon film 15kΩ ±5% 1/4W	
R51	PD14BY2E332J	Insulated carbon film 3.3kΩ ±5% 1/4W	
R52	PD14BY2E821J	Insulated carbon film 820Ω ±5% 1/4W	
R53	PD14BY2E123J	Insulated carbon film 12kΩ ±5% 1/4W	
R54, 55	PD14BY2E222J	Insulated carbon film 2.2kΩ ±5% 1/4W	
R56	PD14BY2E472J	Insulated carbon film 4.7kΩ ±5% 1/4W	
R58, 59	RN14AB3F153J	Metal film 15kΩ ±5% 3W	
R60	RN14AB3A221J	Metal film 220Ω ±5% 1W	
R61	PD14BY2E561J	Insulated carbon film 560Ω ±5% 1/4W	
R62	PD14BY2E152J	Insulated carbon film 1.5kΩ ±5% 1/4W	
R63	PD14BY2H470J	Insulated carbon film 47Ω ±5% 1/2W	
R64	PD14BY2E181J	Insulated carbon film 180Ω ±5% 1/4W	
R65	RN14AB3D471J	Metal film 470Ω ±5% 2W	
R66	RN14AB3F123J	Metal film 12kΩ ±5% 3W	
R67	PD14BY2H473J	Insulated carbon film 47kΩ ±5% 1/2W	
R70, 71	R92-0055-25	SC resistor 1MΩ ±5% 1W	
R72	PD14BY2H474J	Insulated carbon film 470kΩ ±5% 1/2W	
R73	R92-0055-25	SC resistor 1MΩ ±5% 1W	
R74	R92-0056-25	SC resistor 820kΩ ±5% 1W	
R77	PD14BY2H474J	Insulated carbon film 470kΩ ±5% 1/2W	
R78	PD14BY2E332J	Insulated carbon film 3.3kΩ ±5% 1/4W	
R79	PD14BY2E272J	Insulated carbon film 2.7kΩ ±5% 1/4W	
R80,	PD14BY2E104J	Insulated carbon film 100kΩ ±5% 1/4W	
R81	PD14BY2E822J	Insulated carbon film 8.2kΩ ±5% 1/4W	
R82	PD14BY2E101J	Insulated carbon film 100Ω ±5% 1/4W	

## PARTS LIST OF X65-0008-01

Circuit No.	Parts No.	Description	Remarks
R90	PD14BY2E472J	Insulated carbon film 4.7kΩ ±5% 1/4W	
R91	PD14BY2E474J	Insulated carbon film 470kΩ ±5% 1/4W	
R92	PD14BY2E392J	Insulated carbon film 3.9kΩ ±5% 1/4W	
R93	PD14BY2E104J	Insulated carbon film 100kΩ ±5% 1/4W	
<b>CAPACITOR</b>			
C1,2	CK94YY2H103M	Ceramic 0.01μF ±20% 500V	
C3	CE04W1H010	PC electrolytic 1μ 50V	
C4	CC94SL2H470J	Ceramic 47pF ±5% 500V	
C5	CE04W1C101	PC electrolytic 100μF 16V	
C6	CE04D1H010N	Non-polarized electrolytic 1μF 50V	
C7	CC94SL2H101J	Ceramic 100pF ±5% 500V	
C8	CC94SL2H150J	Ceramic 15pF ±5% 500V	
C9	CC94SL2H050D	Ceramic 5pF ±0.5% 500V	
C10	CK94YY2H103M	Ceramic 0.01μF ±20% 500V	
C11	CC94SL2H101J	Ceramic 100pF ±5% 500V	
C12	CK94YY2H681M	Ceramic 680pF ±20% 500V	
C13	CC94SL2H300J	Ceramic 30pF ±5% 500V	
C14	CK94YY2H331M	Ceramic 330pF ±20% 500V	
C15	CK94YY2H103M	Ceramic 0.01μF ±20% 500V	
C16	CQ93M1H122J	Mylar 1200pF ±5% 50V	
C18	CK94YY2H103M	Ceramic 0.01μF ±20% 500V	
C19	CE04W1C471	PC electrolytic 470μF 16V	
C20~22	CE04W1H470	PC electrolytic 47μF 50V	
C23	CE04W1E470	PC electrolytic 47μF 25V	
C24	CE04W1H470	PC electrolytic 47μF 50V	
C25, 26	CE04W1H221	PC electrolytic 220μF 50V	
C27	CE04W1C471	PC electrolytic 470μF 16V	
C28	CE04W1H221	PC electrolytic 220μF 50V	
C29	CK94YY3C103M	Ceramic 0.01μF ±20% 1.6kV	
C30	CM91B3C220K	Mica 22pF ±10% 1.6kV	
C34	CC94SL1H100D	Ceramic 10pF ±0.5% 50V	
C35	CE04W1C101	PC electrolytic 100μF 16V	
C36 37	CK94YY1H222M	Ceramic 0.0022μF ±20% 50V	
C38	CK94YY1H471M	Ceramic 470pF ±20% 50V	
C39	CK94YY1H222M	Ceramic 0.0022μF ±20% 50V	
C40	CK94YY2H221M	Ceramic 220pF ±20% 500V	
TC1	C05-0029-15	Ceramic trimmer 50pF	



## PARTS LIST OF X73-0011-00

Circuit No.	Parts No.	Description	Remarks
—	J25-0444-13	PC board	
—	F02-0004-05	Heat sink	
—	F11-0026-04	Shield case	
S1	S40-2007-15	Pushbutton switch	
<b>SEMICONDUCTOR</b>			
Q2, 4		2SK19 (GR)	
Q5~8		2SK30 (O)	
Q9~30		2SC458 (C)	
Q31, 32		2SC526	
Q33~37		2SC458 (C)	
Q38, 39		2SA562 (Y)	
Q40		2SC458 (C)	
Q41, 42		2SC371 (R)	
Q43		2SA562 (Y)	
Q44		2SC458 (C)	
Q45		2SC627 (3)	
Q46, 47		2SC458 (C)	
D1~8		1S1555	
D9, 10		1N60	
D11, 12		1S1555	
<b>POTENTIOMETER</b>			
VR1	R12-0004-05	PC trimmer potentiometer	330Ω (B)
VR2	R12-3004-05	PC trimmer potentiometer	47kΩ (B)
VR3	R12-0004-05	PC trimmer potentiometer	330Ω (B)
VR4	R12-3004-05	PC trimmer potentiometer	47kΩ (B)
VR5, 6	R12-1004-05	PC trimmer potentiometer	4.7kΩ (B)
<b>RESISTOR</b>			
R3	PD14BY2E104J	Insulated carbon film	100k ±5% 1/4W
R4	PD14BY2E102J	Insulated carbon film	1kΩ ±5% 1/4W
R5	PD14BY2H105F	Insulated carbon film	1MΩ ±1% 1/2W
R6	PD14BY2E102J	Insulated carbon film	1kΩ ±5% 1/4W
R7~9	PD14BY2E562J	Insulated carbon film	5.6kΩ ±5% 1/4W
R10	PD14BY2E101J	Insulated carbon film	100Ω ±5% 1/4W
R11, 12	PD14BY2E562J	Insulated carbon film	5.6kΩ ±5% 1/4W
R13, 14	PD14BY2E272J	Insulated carbon film	2.7kΩ ±5% 1/4W
R16	PD14BY2E152J	Insulated carbon film	1.5kΩ ±5% 1/4W
R17	PD14BY2E332J	Insulated carbon film	3.3kΩ ±5% 1/4W
R18, 19	PD14BY2E272J	Insulated carbon film	2.7kΩ ±5% 1/4W
R20	PD14BY2E332J	Insulated carbon film	3.3kΩ ±5% 1/4W
R23	PD14BY2E104J	Insulated carbon film	100kΩ ±5% 1/4W
R24	PD14BY2E102J	Insulated carbon film	1kΩ ±5% 1/4W
R25	PD14BY2H105F	Insulated carbon film	1MΩ ±1% 1/2W
R26	PD14BY2E102J	Insulated carbon film	1kΩ ±5% 1/4W
R27~29	PD14BY2E562J	Insulated carbon film	5.6kΩ ±5% 1/4W
R30	PD14BY2E101J	Insulated carbon film	100Ω ±5% 1/4W
R31, 32	PD14BY2E562J	Insulated carbon film	5.6kΩ ±5% 1/4W
R33, 34	PD14BY2E272J	Insulated carbon film	2.7kΩ ±5% 1/4W

## PARTS LIST OF X73-0011-00

Circuit No.	Parts No.	Description	Remarks
R36	PD14BY2E152J	Insulated carbon film 1.5k $\Omega$ $\pm$ 5%	1/4W
R37	PD14BY2E332J	Insulated carbon film 3.3k $\Omega$ $\pm$ 5%	1/4W
R38, 39	PD14BY2E272J	Insulated carbon film 2.7k $\Omega$ $\pm$ 5%	1/4W
R40	PD14BY2E332J	Insulated carbon film 3.3k $\Omega$ $\pm$ 5%	1/4W
R45~48	PD14BY2E102J	Insulated carbon film 1k $\Omega$ $\pm$ 5%	1/4W
R49, 50	PD14BY2E822J	Insulated carbon film 8.2k $\Omega$ $\pm$ 5%	1/4W
R51, 52	PD14BY2E272J	Insulated carbon film 2.7k $\Omega$ $\pm$ 5%	1/4W
R53	PD14BY2E681J	Insulated carbon film 680 $\Omega$ $\pm$ 5%	1/4W
R54, 55	PD14BY2E102J	Insulated carbon film 1k $\Omega$ $\pm$ 5%	1/4W
R56, 57	PD14BY2E222J	Insulated carbon film 2.2k $\Omega$ $\pm$ 5%	1/4W
R58, 59	PD14BY2E153J	Insulated carbon film 15k $\Omega$ $\pm$ 5%	1/4W
R60, 61	PD14BY2E122J	Insulated carbon film 1.2k $\Omega$ $\pm$ 5%	1/4W
R62	PD14BY2E102J	Insulated carbon film 1k $\Omega$ $\pm$ 5%	1/4W
R63	PD14BY2E181J	Insulated carbon film 180k $\Omega$ $\pm$ 5%	1/4W
R64, 65	PD14BY2E272J	Insulated carbon film 2.7k $\Omega$ $\pm$ 5%	1/4W
R66, 67	RN14AA3A472J	Metal film 4.7k $\Omega$ $\pm$ 5%	1W
R68, 69	PD14BY2E103J	Insulated carbon film 10k $\Omega$ $\pm$ 5%	1/4W
R70, 71	PD14BY2E562J	Insulated carbon film 5.6k $\Omega$ $\pm$ 5%	1/4W
R72, 73	PD14BY2E272J	Insulated carbon film 2.7k $\Omega$ $\pm$ 5%	1/4W
R74	PD14BY2E151J	Insulated carbon film 150 $\Omega$ $\pm$ 5%	1/4W
R75, 76	PD14BY2E222J	Insulated carbon film 2.2k $\Omega$ $\pm$ 5%	1/4W
R77, 78	PD14BY2E682J	Insulated carbon film 6.8k $\Omega$ $\pm$ 5%	1/4W
R79	PD14BY2E561J	Insulated carbon film 560 $\Omega$ $\pm$ 5%	1/4W
R80	PD14BY2E182J	Insulated carbon film 1.8k $\Omega$ $\pm$ 5%	1/4W
R81	PD14BY2E102J	Insulated carbon film 1k $\Omega$ $\pm$ 5%	1/4W
R82	PD14BY2E272J	Insulated carbon film 2.7k $\Omega$ $\pm$ 5%	1/4W
R83	PD14BY2E562J	Insulated carbon film 5.6k $\Omega$ $\pm$ 5%	1/4W
R84	PD14BY2E391J	Insulated carbon film 390 $\Omega$ $\pm$ 5%	1/4W
R85	PD14BY2E471J	Insulated carbon film 470 $\Omega$ $\pm$ 5%	1/4W
R86	PD14BY2H102J	Insulated carbon film 1k $\Omega$ $\pm$ 5%	1/2W
R87	PD14BY2E153J	Insulated carbon film 15k $\Omega$ $\pm$ 5%	1/4W
R88	PD14BY2E104J	Insulated carbon film 100k $\Omega$ $\pm$ 5%	1/4W
R89	PD14BY2E223J	Insulated carbon film 22k $\Omega$ $\pm$ 5%	1/4W
R90	PD14BY2E683J	Insulated carbon film 68k $\Omega$ $\pm$ 5%	1/4W
R91	PD14BY2E563J	Insulated carbon film 56k $\Omega$ $\pm$ 5%	1/4W
R92	PD14BY2E104J	Insulated carbon film 100k $\Omega$ $\pm$ 5%	1/4W
R93	PD14BY2E223J	Insulated carbon film 22k $\Omega$ $\pm$ 5%	1/4W
R94	PD14BY2H102J	Insulated carbon film 1k $\Omega$ $\pm$ 5%	1/2W
R95	PD14BY2E153J	Insulated carbon film 15k $\Omega$ $\pm$ 5%	1/4W
R96	PD14BY2H102J	Insulated carbon film 1k $\Omega$ $\pm$ 5%	1/2W
R97	PD14BY2E472J	Insulated carbon film 4.7k $\Omega$ $\pm$ 5%	1/4W
R98, 99	PD14BY2E562J	Insulated carbon film 5.6k $\Omega$ $\pm$ 5%	1/4W
R100	PD14BY2E274J	Insulated carbon film 270k $\Omega$ $\pm$ 5%	1/4W
R101	PD14BY2E222J	Insulated carbon film 2.2k $\Omega$ $\pm$ 5%	1/4W
R102	PD14BY2E333J	Insulated carbon film 33k $\Omega$ $\pm$ 5%	1/4W
R103	PD14BY2E102J	Insulated carbon film 1k $\Omega$ $\pm$ 5%	1/4W
R104	PD14BY2E153J	Insulated carbon film 15k $\Omega$ $\pm$ 5%	1/4W
R105	PD14BY2E104J	Insulated carbon film 100k $\Omega$ $\pm$ 5%	1/4W
R106	PD14BY2E224J	Insulated carbon film 220k $\Omega$ $\pm$ 5%	1/4W
R107	PD14BY2E101J	Insulated carbon film 100 $\Omega$ $\pm$ 5%	1/4W

## PARTS LIST OF X73-0011-00

Circuit No.	Parts No.	Description	Remarks
<b>CAPACITOR</b>			
C1	CK94YY2H103M	Ceramic	0.01 $\mu$ F $\pm$ 20%    500V
C2~4	CE04W1C470	PC electrolytic	47 $\mu$ F    16V
C5	CC94SL1H151J	Ceramic	150pF $\pm$ 5%    50V
C7	CK94YY2H103M	Ceramic	0.01 $\mu$ F $\pm$ 20%    500V
C8	CE04W1C470	PC electrolytic	47 $\mu$ F    16V
C9	CC94SL1H101J	Ceramic	100pF $\pm$ 5%    50V
C11	CC94SL1H150J	Ceramic	15pF $\pm$ 5%    50V
C12	CC94SL1H220J	Ceramic	22pF $\pm$ 5%    50V
C13	CC94SL1H330J	Ceramic	33pF $\pm$ 5%    50V
C14, 15	CK94YY1H103M	Ceramic	0.01 $\mu$ F $\pm$ 20%    50V
C16, 17	CE04W1C470	PC electrolytic	47 $\mu$ F    16V
C18	CC94SL1H221K	Ceramic	220pF $\pm$ 10%    50V
C19~21	CC94SL1H151J	Ceramic	150pF $\pm$ 5%    50V
C22	CC94SL1H680J	Ceramic	68pF $\pm$ 5%    50V
C23	CE04W1H220	PC electrolytic	22 $\mu$ F    50V
C24	CE04W1C470	PC electrolytic	47 $\mu$ F    16V
C25, 26	CK94YY1H103M	Ceramic	0.01 $\mu$ F $\pm$ 20%    50V
C27	CC94SL2H050D	Ceramic	5pF $\pm$ 0.5%    500V
C28	CE04W1H101	PC electrolytic	100 $\mu$ F    50V
C29	CE02D2E220	PC electrolytic	22 $\mu$ F    250V
TC1	C05-0029-15	Ceramic trimmer	50pF
<b>COIL</b>			
L1, 2	L33-0060-05	Peaking coil	

# BLOCK DIAGRAM

MODEL CS-1554 OSCILLOSCOPE BLOCK DIAGRAM

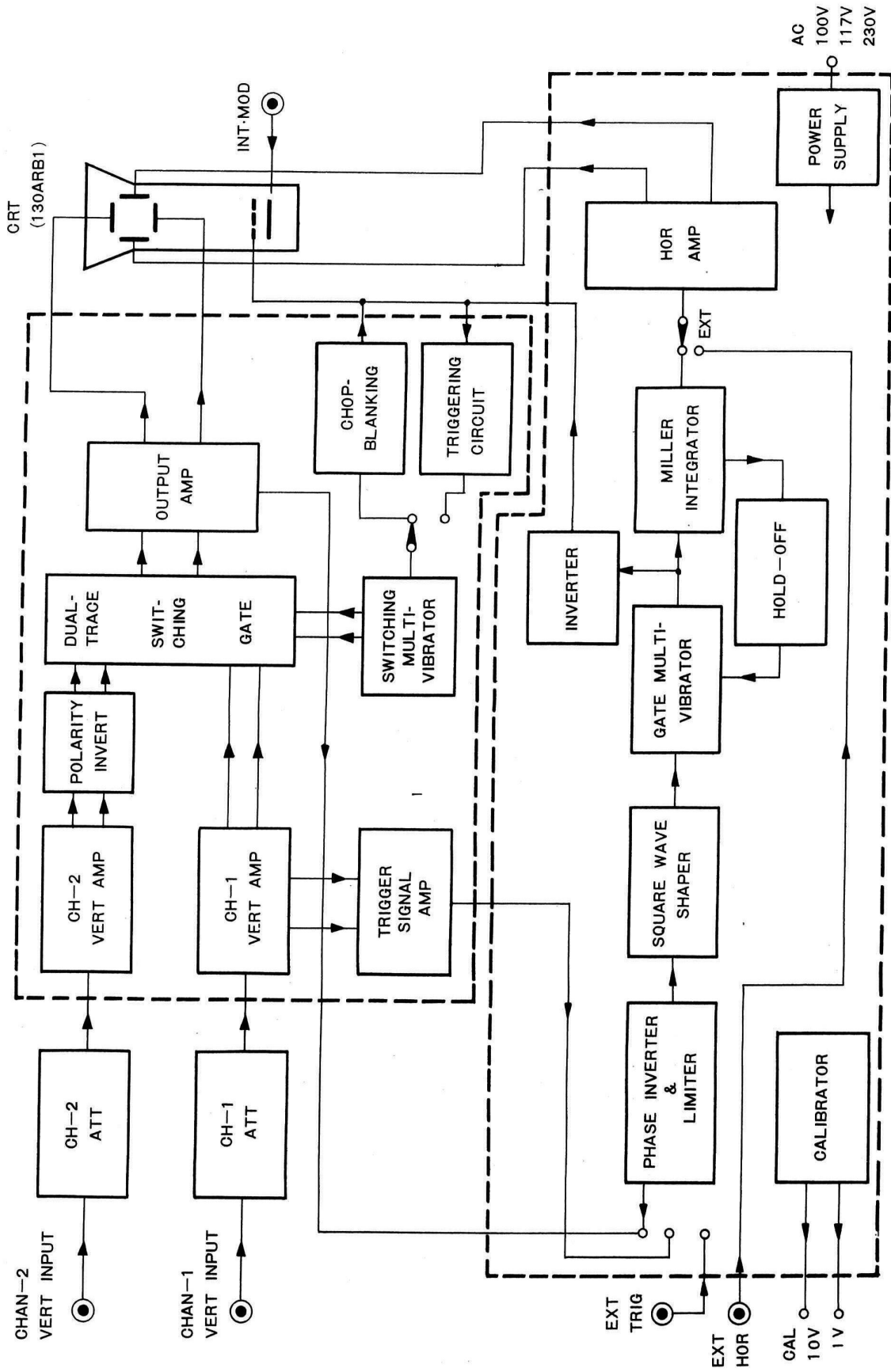

# COLOR CODE

## RESISTOR

COLOR (meaning)	1st (value)	2nd (value)	3rd (multiplier)	4th (tolerance)
Black	0	0	$10^0$	—
Brown	1	1	$10^1$	$\pm 1\%$
Red	2	2	$10^2$	$\pm 2\%$
Orange	3	3	$10^3$	—
Yellow	4	4	$10^4$	—
Green	5	5	$10^5$	—
Blue	6	6	$10^6$	—
Purple	7	7	$10^7$	—
Grey	8	8	$10^8$	—
White	9	9	$10^9$	—
Gold	—	—	$10^{-1}$	$\pm 5\%$
Silver	—	—	$10^{-2}$	$\pm 10\%$
Non-color	—	—	—	$\pm 20\%$

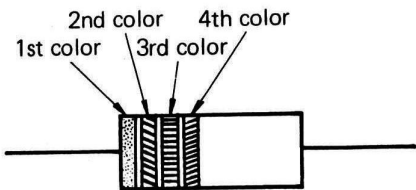

## CAPACITOR (MICA)

COLOR (meaning)	1st (grade)	2nd (value)	3rd (value)	4th (multiplier)	5th (tolerance)	6th (characteristic)
Black	X	0	0	$10^0$	$\pm 20\%$	—
Brown	—	1	1	$10^1$	$\pm 1\%$	B
Red	Z	2	2	$10^2$	$\pm 2\%$	C
Orange	—	3	3	$10^3$	—	D
Yellow	—	4	4	$10^4$	—	E
Green	—	5	5	—	$*\pm 5\%$	—
Blue	—	6	6	—	—	—
Purple	—	7	7	—	—	—
Grey	Y	8	8	—	—	—
White	—	9	9	0.1	$\pm 10\%$	—

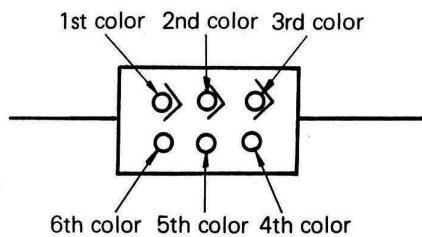

Unit = pF  
 \* Capacitance being less than 10 pF is  $\pm 0.5$  pF on tolerance.



---

Manufactured by TRIO ELECTRONICS INC., TOKYO, JAPAN.

# PC BOARD VERTICAL AMPLIFIER UNIT(X73-0011-00)

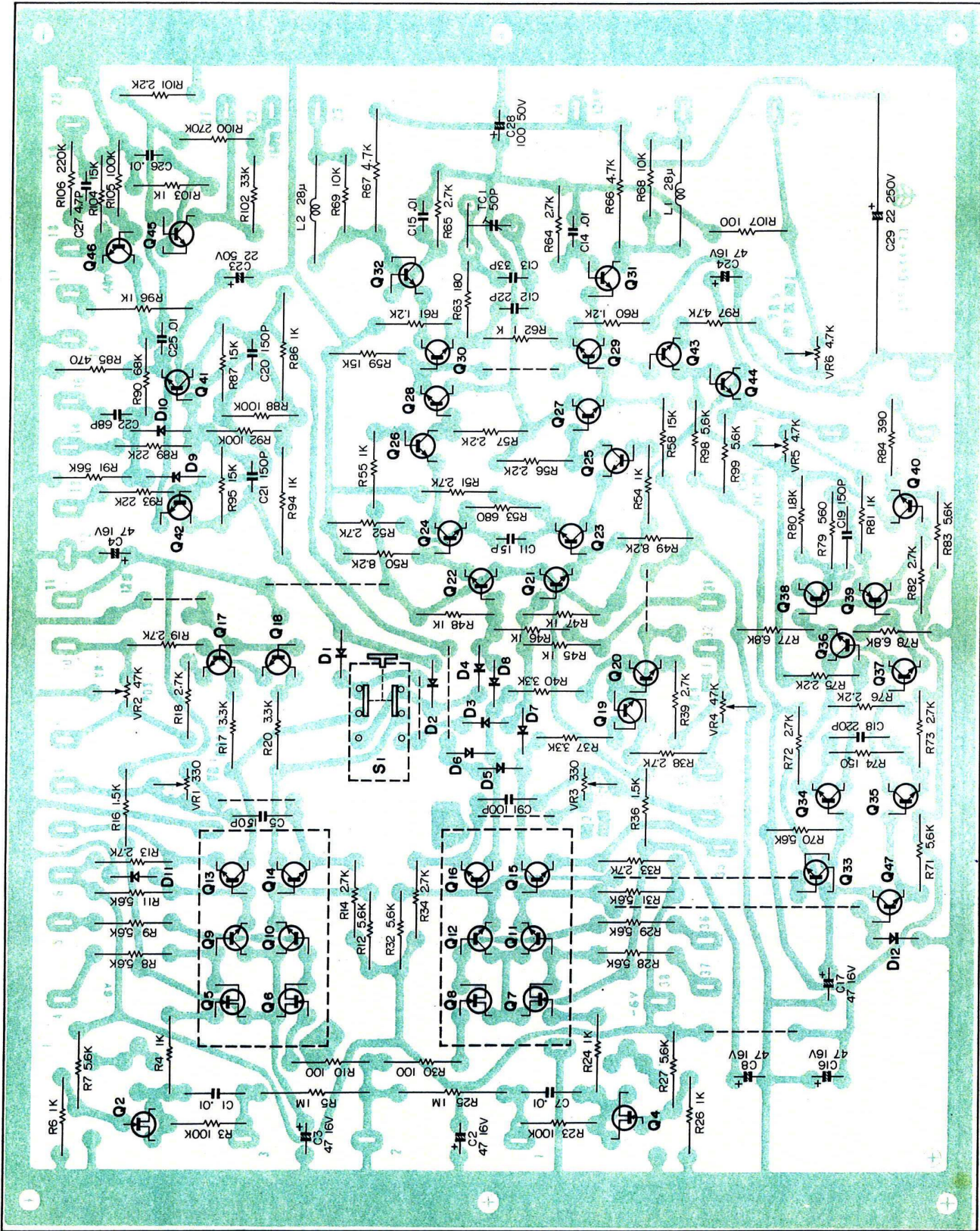

Q2,4: 2SK-19-G(19SS), Q5-8: 2SK-30(O), Q9-30,40,44,46,47: 2SC-458(C), Q31,32: 2SC-526, Q33-37: 2SC-458(Y), Q38,39,43: 2SA-562(Y), Q41,42: 2SC-371(R)  
 Q45: 2SC-627-2, D1-8,11,12: 1S-1555, D9,10: 1N60

# PC BOARD HORIZONTAL AMPLIFIER UNIT (X65-0008-01)

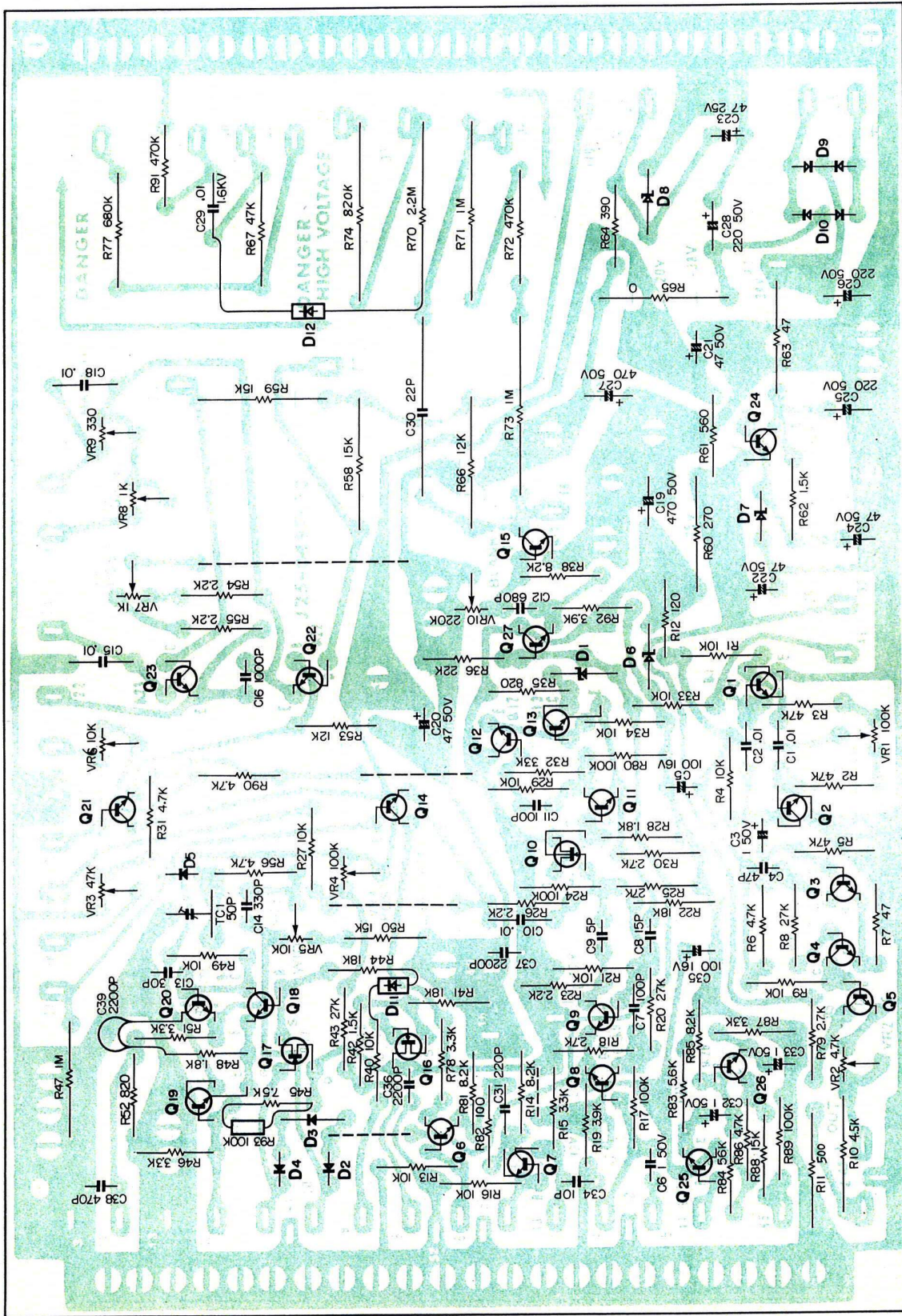

Q1: 9, 11-14, 18-21, 27 : 25C371 (R), Q10: 35K22 (GR) Q15, 22-24: 25C627 (2), Q16: 25K30 (GR) Q17: 25K30 (O) D1, 8: ZB1-6, D2, 4, 5: 1S1555, D3: 1N60  
 D6: ZB1-12, D7: SZ-200-25, D9: 1S1850, D10: 1S1850R, D11: 1S1555,



