

KENWOOD

20MHz OSCILLOSCOPE

CS-4025

SERVICE MANUAL

KENWOOD CORPORATION

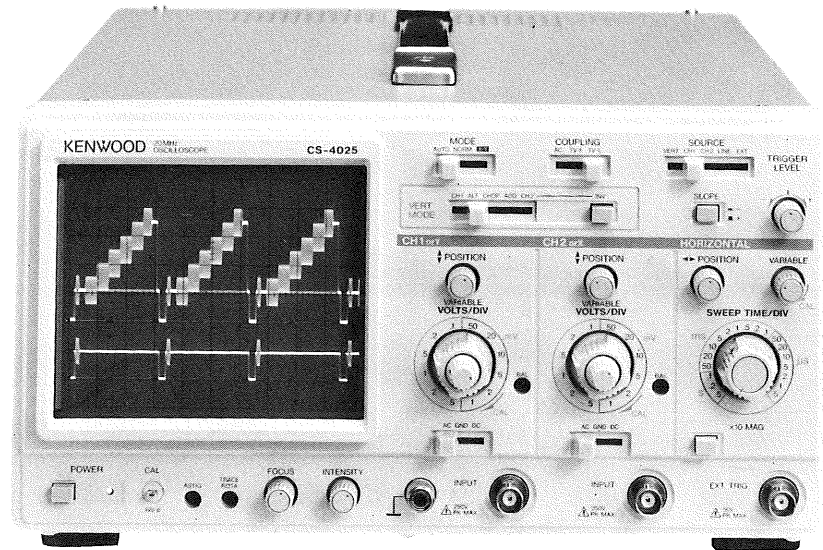

WARNING

The following instructions are for use by qualified personnel only. To avoid electric shock, do not perform any servicing other than contained in the operating instructions unless you are qualified to do so.

CONTENTS

SPECIFICATIONS	3
SAFETY	6
CIRCUIT DESCRIPTION	7
BLOCK DIAGRAM	9
ADJUSTMENT	10
TROUBLESHOOTING	15
PARTS LIST	20
DISASSEMBLY	21
PARTS LIST (ELECTRICAL)	22
SCHEMATIC DIAGRAM/WAVEFORM	26
P.C. BOARD	31
SEMICONDUCTORS	33

SPECIFICATION

CS-4025	
CRT:	
Type:	Rectangular with internal graticule
Acceleration Voltage:	Approx. 2 kV
Display Area:	8 × 10 div (1 div = 10 mm)
VERTICAL AXIS (CH1 and CH2):	
Sensitivity:	1 mV · 2 mV/div ± 5%; 5 mV ~ 5 V ± 3%
Attenuator:	1-2-5 step, 12 range with fine adjustment
Input Impedance:	1 MΩ ± 2% resistance Approx. 28 pF capacitance
Frequency Response	
5 mV/div ~ 5 V/div:	DC: DC ~ 20 MHz within - 3 dB AC: 10 Hz ~ 20 MHz within - 3 dB
1 mV/div · 2 mV/div:	DC: DC ~ 5 MHz within - 3 dB AC: 10 Hz ~ 5 MHz within - 3 dB
Rise Time:	17.5 ns maximum (20 MHz) 70 ns maximum (5 MHz)
Crosstalk:	- 40 dB maximum
Operating Modes:	CH1: CH1 single trace CH2: CH2 single trace ALT: Alternating display of two signals CHOP: Chopped display of two signals ADD: Display of combined CH1 + CH2 waveforms
CHOP Frequency:	Approx. 250 kHz
Channel Polarity:	Normal or inverted, channel 2 only inverted
Maximum Input Voltage:	500 V _{P-P} or 250 V (DC + AC _{peak})
HORIZONTAL AXIS:	
Sensitivity:	Same as vertical axis (CH2)
Input Impedance:	Same as vertical axis (CH2)
Frequency Response:	DC: DC ~ 500 kHz within - 3 dB AC: 10 Hz ~ 500 kHz within - 3 dB
X-Y Phase Difference:	3° or less at 50 kHz
Operating Modes:	X-Y operation is selectable with MODE switch CH1: Y-axis CH2: X-axis
Maximum Input Voltage:	Same as vertical axis (CH2)
SWEEP SYSTEM:	
Sweep Modes:	NORM: Triggered sweep AUTO: Auto free run with no signal input
Sweep Time:	0.5 μs/div ~ 0.5 s/div, ± 3% 1-2-5 step, 19 range with fine adjustment
Sweep Expansion:	10 × magnification, ± 5%
Linearity:	± 3% (± 5% at × 10 MAG)

SPECIFICATIONS

CS-4025																									
TRIGGERING:																									
Trigger Signal Sources:	VERT: Input signal selection with VERT MODE control CH1: CH1 input signal CH2: CH2 input signal LINE: Commercial-use power source EXT: Signal input through EXT.TRIG terminal																								
External trigger:																									
Input impedance:	1 M Ω ; Approx 35 pF																								
Maximum Input Voltage:	100 V _{P-P} or 50 V (DC + AC _{peak})																								
Trigger Coupling Modes:	AC: Trigger is capacitively coupled; dc component is blocked. TV-F: Vertical sync pulses of a composite video signal are selected for triggering. TV-L: Horizontal sync pulses of a composite video signal are selected for triggering.																								
Trigger Sensitivity:																									
<table border="1" style="width: 100%; border-collapse: collapse; text-align: center;"> <thead> <tr> <th rowspan="2" style="padding: 5px;">MODE</th> <th rowspan="2" style="padding: 5px;">COUPLING</th> <th rowspan="2" style="padding: 5px;">SIGNAL FREQ</th> <th colspan="2" style="padding: 5px;">SOURCE</th> </tr> <tr> <th style="padding: 5px;">VERT CH1, CH2</th> <th style="padding: 5px;">EXT</th> </tr> </thead> <tbody> <tr> <td rowspan="3" style="padding: 5px;">NORM</td> <td rowspan="2" style="padding: 5px;">AC</td> <td style="padding: 5px;">10 Hz ~ 10 MHz</td> <td style="padding: 5px;">1 div</td> <td style="padding: 5px;">0.2 V_{P-P}</td> </tr> <tr> <td style="padding: 5px;">10 MHz ~ 20 MHz</td> <td style="padding: 5px;">1.5 div</td> <td style="padding: 5px;">0.3 V_{P-P}</td> </tr> <tr> <td style="padding: 5px;">TV-F, TV-L</td> <td style="padding: 5px;">Composite Video Signal</td> <td style="padding: 5px;">1 div</td> <td style="padding: 5px;">0.2 V_{P-P}</td> </tr> <tr> <td style="padding: 5px;">AUTO</td> <td colspan="4" style="padding: 5px;">Same as above specs at 50 Hz or above</td> </tr> </tbody> </table>		MODE	COUPLING	SIGNAL FREQ	SOURCE		VERT CH1, CH2	EXT	NORM	AC	10 Hz ~ 10 MHz	1 div	0.2 V _{P-P}	10 MHz ~ 20 MHz	1.5 div	0.3 V _{P-P}	TV-F, TV-L	Composite Video Signal	1 div	0.2 V _{P-P}	AUTO	Same as above specs at 50 Hz or above			
MODE	COUPLING				SIGNAL FREQ	SOURCE																			
		VERT CH1, CH2	EXT																						
NORM	AC	10 Hz ~ 10 MHz	1 div	0.2 V _{P-P}																					
		10 MHz ~ 20 MHz	1.5 div	0.3 V _{P-P}																					
	TV-F, TV-L	Composite Video Signal	1 div	0.2 V _{P-P}																					
AUTO	Same as above specs at 50 Hz or above																								
CALIBRATED SIGNALS:																									
Waveform:	Positive square wave																								
Voltage:	1 V _{P-P} , $\pm 3\%$																								
Frequency:	100 Hz or 120 Hz																								
INTENSITY MODULATION:																									
Sensitivity:	TTL level, positive voltage decreases brightness																								
Input Impedance:	Approx. 5 k Ω																								
Usable Frequency Range:	DC ~ 3.5 MHz																								
Maximum Input Voltage:	100 V _{P-P} or 50 V (DC + AC _{peak})																								
CH1 SIGNAL OUTPUT:																									
Output Voltage:	Approx. 50 mV/div (50 Ω termination)																								
Output Impedance:	Approx. 50 Ω																								
Frequency Response:	100 Hz ~ 10 MHz within ± 3 dB (50 Ω termination)																								
TRACE ROTATION:																									
Adjustment:	Adjustable from front panel																								
POWER SOURCE:																									
Line Voltage:	AC 100 V/120 V/220 V/240 V, $\pm 10\%$																								
Line Frequency:	50/60 Hz																								
Power Consumption:	Approx. 29 W																								
DIMENSIONS/WEIGHT (figures in parenthesis include attachments):																									
Width:	290 mm (290 mm)																								
Height:	150 mm (170 mm)																								
Depth:	380 mm (440 mm)																								
Weight:	Approx. 6.8 kg																								

SPECIFICATIONS

	CS-4025
ENVIRONMENTAL:	
Within specifications:	Temp: 10~35°C; Humidity: 85% max
Full operation:	Temp: 0~40°C; Humidity: 85% max
ACCESSORIES:	
Probes (PC-35)	2 Attenuation: 1/10 Input impedance: 10 MΩ (± 2%); 19.5 pF (± 10%)
Instruction manual:	1
Power supply cable:	1 (Power cord receptacle type only)
Replacement fuse:	2

Note: _____
 The above specifications are subject to change without notice.

SAFETY

SAFETY

Before connecting the instrument to a power source, carefully read the following information, then verify that the proper power cord is used and the proper line fuse is installed for power source. If the power cord is not applied for specified voltage, there is always a certain amount of danger from electric shock.

Line voltage

This instrument operates using ac-power input voltages that 100/120/220/240 V at frequencies from 50 Hz to 60 Hz.

Power cord

The ground wire of the 3-wire ac power plug places the chassis and housing of the oscilloscope at earth ground. Do not attempt to defeat the ground wire connection or float the oscilloscope; to do so may pose a great safety hazard.

The appropriate power cord is supplied by an option that is specified when the instrument is ordered.

The optional power cords are shown as follows in Fig. 1.

Line fuse

The fuse holder is located inside the instrument or on the rear panel and contains the line fuse. Verify that the proper fuse is installed by replacing the line fuse.

Voltage conversion

This oscilloscope may be operated from a 100 V to 240 V, 50/60 Hz power source. Use the following procedure to change from 100 to 240 volt operation or vice versa.

1. Remove the fuse.
2. Replace fuse F 1 with a fuse of appropriate value, 0.8 amp for 100 VAC to 120 VAC operation, 0.5 amp for 220 VAC to 240 VAC operation.
3. Reinsert it for appropriate voltage range.
4. When performing the reinsertion of fuse holder for the voltage conversion, the appropriate power cord should be used. (See Fig. 1.)



Plug configuration	Power cord and plug type	Factory installed instrument fuse	Line cord plug fuse	Parts No. for power cord or cord set
	North American 120 volt/60 Hz Rated 15 amp (12 amp max; NEC)	0.8 A, 250 V Fast blow 6 × 30 mm	None	Cord: E30-1854-05 Cord set: E30-1820-05
	Universal Europe 220 volt/50 Hz Rated 16 amp	North Europe 500 mA, 250 V Slow blow 5 × 20 mm Other Europe 0.5 A, 250 V Fast blow 6 × 30 mm	None	Cord: E30-1852-05 Cord set: E30-1819-05
	U.K. 240 volt/50 Hz Rated 13 amp	0.5 A, 250 V Fast blow 6 × 30 mm	0.8 A Type C	—
	Australian 240 volt/50 Hz Rated 10 amp	0.5 A, 250 V Fast blow 6 × 30 mm	None	Cord: E30-1853-05 Cord set: E30-1821-05
	North American 240 volt/60 Hz Rated 15 amp (12 amp max; NEC)	0.5 A, 250 V Fast blow 6 × 30 mm	None	—
	Switzerland 240 volt/50 Hz Rated 10 amp	0.5 A, 250 V Fast blow 6 × 30 mm	None	—

Fig. 1 Power Input Voltage Configuration

CIRCUIT DESCRIPTION

VERTICAL ATTENUATOR CIRCUIT

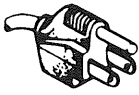
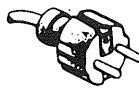
The attenuators of channel 1 and 2 basically consist of rotary switches and passive elements (resistors, condensers, and trimmer condensers) on PC boards. The resistors have a precision of 0.5% for minimizing any error between the steps of the attenuators.

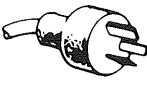
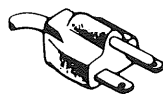
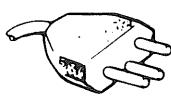
Vertical input signals from the BNC input receptacle enter the first-stage attenuator circuit, along the path selected by the AC-GND-DC switch. Then they pass through either attenuator 1/1, 1/10, or 1/100, along the path selected by the vertical rotary switch, and become input into the 1st preamplifier (first-stage buffer amplifier).

The 1st preamplifier consists of U1 and Q1 (CH2: U2 and Q2). The element used for U1 features a wide dynamic range and minimized temperature drifting. U1 functions in the preamplifier as a circuit in which temperature drifting is considered. Input signals, impedance converted in this buffer amplifier, are sent to the second-stage attenuator where they are passed through either attenuator 1/1, 1/2, 1/4, or 1/10. They are then sent to the vertical amplifier. The second-stage attenuator constitutes a low impedance resistance network with favorable frequency characteristics. The resistors used, as is those of the first-stage attenuator, have a precision of 0.5% for minimizing any error between the steps of the attenuators. The rotary switches in this stage include one which increases the gain of the preamplifier to 5-fold when the sensitivity is 1 mV/div or 2 mV/div.

Q1 (Q2) is provided in the input circuit as a diode equivalent for protecting the elements (U1 and U2) during a great amplitude input.

TC1 (51) and TC3 (53) are input capacitance regulators for attenuator 1/10 and 1/100, respectively; while TC2 (52) and TC4 (54) are 1 kHz square wave characteristic regulators for attenuator 1/10 and 1/100. VR1 (51) and VR2 (52) are step DC balance regulators for attenuators, the former is for user use with adjustment enabled from the front panel.

VERTICAL PREAMPLIFIER CIRCUIT

Signals output from the attenuator circuits are then input into the 2nd preamplifier which consists of a U3 (4) hybrid IC. This IC, with a gain of approximately 12-fold, is an amplifier for suppressing DC level temperature drifting. When the sensitivity is either 1 mV/div or 2 mV/div, the gain is further increased another 5-fold (sum of approximately 60-fold) as a result of the gain resistivity of U3 (4) being switched over by the second attenuator switches S1 d and e. VR3 (53) is the regulator for the DC offset which occurs during this time. Setting the 5-fold gain is done by a resistor with a 1% precision and a non-regulated operation is achieved. VR4 (54) and VR5 (55) are 1 kHz square wave characteristic regulators for the sensitivity of 1 mV/div and 2 mV/div.

Signals which become sufficiently amplified in the 2nd preamplifier pass through the vertical axis sensitivity variable circuit, constituted by the volume of the attenuator rotary switch, and then become input into the 3rd amplifier. The 3rd amplifier is a U5 (6) hybrid IC. Signals input into this amplifier become as complementary signals 33 and are output to the 4th amplifier as electric current signals. The IC contains the CH1 (CH2) position circuit, CH2 INV circuit, and CH switch circuit. These are controlled by the CH1 (CH2) position volume and CH2 INV switch on the panel unit (X66-1100-00) and the vertical mode

switch signals coming from the horizontal side.

VR57 is a sensitivity regulator for CH2 signals while TC6 and TC56 are frequency characteristic regulators for CH1 and CH2, respectively.

CH1 (CH2) trigger signals from the 3rd terminal of U5 (6) become amplified in the feedback amplifier in Q16 (19). These trigger signals are converted into electric current signals in Q17 (20) and sent to the trigger source switch on the horizontal side. CH1 trigger signals become amplified between the collector of Q16 and Q18 and in turn become output as CH1 output signals via the emitter follower of Q23. In contrast, CH2 trigger signals become amplified between the collectors in Q19 to Q21, become X-axis signals by being passed through the emitter follower in Q22, converted into electric current signals in VR151 and R182, and in turn output into the horizontal signal switch circuit on the horizontal side. VR151 is the sensitivity regulator of X signals while VR152 is an X position regulator for regulating the DC level of X signals.

The electric current signals which were switched over in the 3rd amplifier are input into the 4th amplifier consisting of Q4 and Q5. After becoming amplified they are directly input into the output amplifier as voltage signals. The 4th amplifier is a feedback amplifier which features minimized fluctuation in the frequency characteristics even when the 3rd amplifiers of CH1 and CH2 are parallel-connected during ADD. Also, the vertical output amplifier can be driven by low output impedance. Q3 becomes turned on during ADD. The operating current is passed through R103, R104, and VR101 so that the operating current in the 4th amplifier does not become fluctuated when the operating currents from the 3rd amplifiers of CH1 and CH2 flow into the 4th amplifier. VR101 is the ADD balance regulator.

VR102 is the balance regulator of +Y and -Y on the CRT. Adjustment is made so that the luminescent line comes to the center of the CRT.

VERTICAL OUTPUT AMPLIFIER CIRCUIT

Signals output from the 4th amplifier are amplified about 45-fold in the output amplifier, Q6 through Q15, and drive the Y deflecting plate of the CRT.

This output amplifier is a feedback amplifier. The final stage Q12 and Q14 are driven by complimentary emitter followers Q8 and Q10, Q9 and Q11, respectively. By doing so, the linearity of the first and last transition high frequencies is improved and the input impedance is made higher. Q13 and Q15 work to obtain sufficient gain during constant-current loss in Q12 and Q14, respectively. Negative feedback is sufficiently applied as well. Consequently, this circuit achieves low impedance output of large amplitude signals with good linearity.

VR103 is a sensitivity regulator based on CH1 signals for the entire vertical amplifier. TC101 is a frequency characteristic regulator for the entire vertical amplifier in general and for the output amplifier in particular. VR104 is the operating point voltage regulator for the output amplifier.

HORIZONTAL SYSTEM (X65-1380-00)

The horizontal system can be roughly divided up into the trigger circuit, sweep circuit, output circuit, and blanking circuit. The TRIG SOURCE switch on the panel unit drives trigger source switch circuits Q311-Q314, D202-D205, and Q202. Desired trigger signals can be elected. The trigger source switch

CIRCUIT DESCRIPTION

Selected synchronizing signals are sent to the trigger level setting circuits Q204-Q206 and U202a via the emitter follower in Q201. The trigger level setting circuit constitutes a Schmitt circuit and its threshold level can be adjusted by VOLUME for trigger level setting on the panel unit.

Signals are sent to Q207-Q211 for video-synch separation via C206. Q207, D206 and D207 are polarity switch circuits and Q209 is a synch tip clamper. Q211 is a switch circuit for vertical synchronizing signal separation.

Either ordinary synchronizing signals or video-synch signals become selected at U202c and the sweep gate flip-flop becomes activated.

Gate signals from U204b turn Q221 ON/OFF in both AUTO and NORM modes and control the sweep HIC in U201. The interior of U201 comprises a constant-current charged type ramp wave generating circuit and its time constant becomes determined by an S201 code and C215 or C216. If the S201 code is below 1 ms/div, the time constant adjustment circuit in Q219 becomes activated and VR201 contributes in determining the time constant as well.

If there are no trigger signals during the AUTO mode, the AUTO circuits in Q212-Q214 work and generate sweep gates automatically.

U201 does not generate ramp waves as the sweep gate becomes shut by U205b in the X-Y mode.

Q216-Q218, U205b and U205c determine the upper limit and hold off time of ramp waves.

Ramp waves from U201 become output as sweep signals via Q222. Sweep signals and X-axis signals, the latter from the vertical system, become selected by switching circuit Q223, Q224, Q226, and Q227. They are then applied to output systems after Q301.

OUTPUT CIRCUIT

When horizontal signals are input into Q301 and voltage signals, corresponding to the horizontal position, are input into Q306, differential signals become generated by the collectors in Q305 and Q308, Q309 and Q310. Q303-Q311 are feedback amplifiers for constant-current load. They constitute horizontal output amplifiers which feature good linearity and low power consumption. Q315 and Q316 become conductive during X10MAG and increase the horizontal amplifier gain to 10-fold.

Signals from the horizontal output amplifier are sent to the horizontal deflecting plate of the CRT via P7.

BLANKING CIRCUIT

Blanking system circuits generate blanking signals for the CRT and signals which switch each channel in the vertical system. A CHOP transmitter (approx. 500 kHz) constitutes U206a and U206b. Signals from the CHOP transmitter and sweep gate signals become selected at U203b, whereby CHOP signals are selected during a CHOP operation, while sweep gate signals are selected during an ACT operation. The selected signals are divided into 1/2 in U204b, which is T-shaped flip-flop connected, and become channel switching signals.

In contrast, signals from the CHOP transmitter and sweep gate negative-phase signals (U204b Q-signals) are turned into blanking signals in Q230 and U205a. They are then sent to the blanking amplifier in the power supply system.

POWER SUPPLY SYSTEM (X68-1570-00)

The power supply system includes the low voltage circuit and blanking circuit.

Low Voltage Circuit

U1 constitutes an HIC for controlling 4 circuit lines consisting of those for ± 8 V, +140 V, and +5 V. Each voltage becomes determined based on -8 V.

Switching signals for CAL output are extracted from the output of +140 V rectifier diode D1.

The +10 V circuits, D6 and C10, are unstable and constitute a power source for the horizontal sweep HIC.

High Voltage Blanking Circuit

Q8 oscillates at approximately 50 kHz applying the reactance of the converter transformer. The oscillation voltage appearing in the high voltage coil are turned into stable -1800 V in the voltage doubler rectifier circuits C25, C26, D9, and D10, and in rectifier circuits Q9 and U2a. The coil of the CRT heater is switched on by signals from R52.

Voltage signals, approximately 300Vp-p, become extracted from the high voltage coil and used as modulated signals for blanking. This is necessary for employing signals from blanking amplifiers Q15, Q6, and Q7 for the cathode potential. The modulated signals drive the DC regeneration circuits, D11-D14, C23 and C24, and provide signals for controlling the brightness of the CRT G1 electrode.

Q10-Q12 are transistors for controlling the focus and they achieve high pressure resistance by being cascade connected. R50 and R51 are circuits which provide specific voltage to the CRT G2 electrode, while Q13 and Q14 are those for driving the rotation coil.

OTHER CIRCUIT

X81-2810-00 B/3 Circuit

Q1 is turned ON/OFF by switching signals for the calibration from the power supply system. Calibration voltage (100kHz) becomes generated in R3 and R4.

VR1-VR4 are either semi-fixed or adjustable resistors for adjusting the CRT's astigmatism, correcting the CRT's trace rotation, adjusting the CRT's focus and brightness.

X66-1100-00 A/2 Circuit

S1, S2, S4, and S5 are switches which determine the conditions of motion and they control the vertical and horizontal systems. VR4 and VR5 determine the vertical position of each vertical channel, while VR1 determines the horizontal positions. S3 determines the trigger slope and S6 determines the polarity of CH2.

BLOCK DIAGRAM

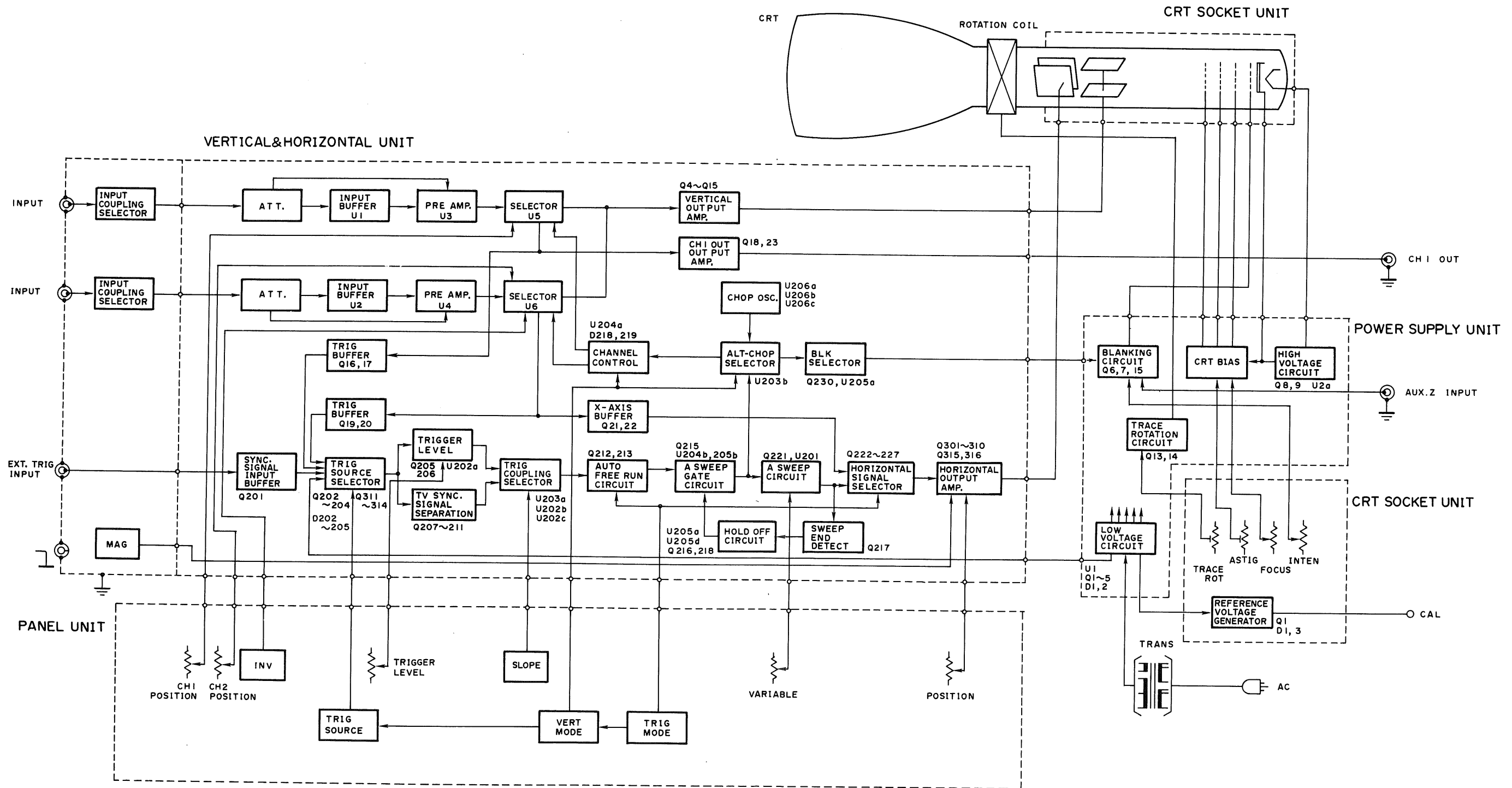

ADJUSTMENT

To obtain the best performance, periodically calibrate the unit. Sometimes, only one mode need be calibrated, while at other times, all modes should be calibrated. When one mode is calibrated, it must be noted that the other modes may be affected. When calibrating all modes, perform the calibration in the specified sequence.

The following calibration required an accurate measuring instrument and an insulated adjusting flat blade screwdriver. If they are not available, contact your dealer. For optimum adjustment, turn the power on and warm up the scope sufficiently (more than 30 minutes) before starting.

Before calibrating the scope, check the power supply voltage.

TEST EQUIPMENT REQUIRED

The following instrument or their equivalent should be used for making adjustment.

Test Equipment	Model	Minimum Specification
Digital Multi-Meter	DL-711 (KENWOOD)	Impedance: More than 10 MΩ, Measuring range: 0.01 V to 199 V
Sine-Wave Generator	651 B (YHP)	Frequency: 10 Hz to 10 MHz, constant voltage over tuning range
Sine-Wave Generator	SG-503 (Tektronix)	Frequency: 50 kHz to 100 MHz, Output impedance: 50 Ω, constant voltage over tuning range
Square-Wave Generator	PG-506 (Tektronix)	Output signal: 1 kHz, Amplitude: 10 mVp-p to 10 Vp-p, Accuracy: within ± 1%, Rise time: 35ns or less 100 kHz, Rise time: 1 ns or less
Q Meter	4343B (YHP)	—
Color Pattern Generator	CG-911A (KENWOOD)	—
Oscilloscope	475A (Tektronix)	Sensitivity: more than 5 mV Frequency response: More than 250 MHz
Time-Marker Generator	TG-501 (Tektronix)	Time mark: 0.5 s to 0.1μs repetitive waveform
High-Voltage Probe	—	Input Impedance: 1000 MΩ
Termination	—	Impedance: 50 Ω Accuracy: within 3%
Termination	—	3 watts type impedance: 50 Ω
Attenuator	—	- 20 dB attenuation (50 Ω)

Table 1

PREPARATION FOR ADJUSTMENT

Control Settings

The control settings listed below must be used for each adjustment procedure.

Exceptions to these settings will be noted as they occur. After completing a adjustment, return the controls to the following settings.

NAME OF KNOBS	POSITION
MODE	AUTO
COUPLING	AC
SOURCE	VERT
VERT MODE	CH1
INV	OFF <input type="checkbox"/>
SLOPE	<input type="checkbox"/> +
TRIGGER LEVEL	12 o'clock
CH1/CH2 POSITION	12 o'clock
CH1/CH2 ATT	10 mV/DIV
CH1/CH2 VARIABLE	Fully clockwise
CH1/CH2 AC-GND-DC	DC
SWEEP POSITION	12 o'clock
SWEEP VARIABLE	Fully clockwise
SWEEP ATT	0.2 ms
x10 MAG	OFF <input type="checkbox"/>
FOCUS	Optimum position
INTENSITY	12 o'clock after adjustment

Table 2

ADJUSTMENT

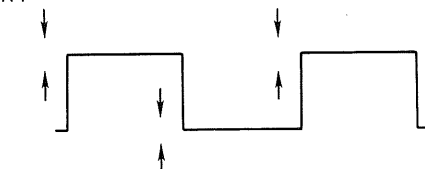
Item	Adjustment VR (TC)	P.C.B.	Procedure
Supply voltage	VR1	X68-1570	Adjust VR1 to give 8.00 V at pin P1-6.
Intensity	VR2	X68-1570	MODE: X-Y With a spot on the screen, turn the INTENSITY knob to a 9 o'clock position and then adjust VR2 until the spot disappears.
CRT center	VR102	X65-1380	CH2: 50 mV/DIV, GND V-MODE: CH2 Pull and push INV to find a position of POSITION knob where the luminescent line does not vary. Leaving POSITION unchanged, adjust to the center of the screen using VR102.
Y operating point	VR104	X65-1380	Position after CRT center adjustment Adjust VR104 to give +57.0 V at pin P6-1.
X operating point	VR301	X65-1380	MODE: X-Y X-POSITION: Center Adjust VR301 to give +68.0 V at pin P7-1.
ASTIG/FOCUS	VR3	X68-1570	MODE: X-Y INTENSITY: 12 o'clock FOCUS: 12 o'clock CH1,2: 50 mV/DIV, GND Adjust the spot "•" to the best position with the ASTIG knob and VR3. *Best position = smallest spot
CH1 Step ATT Balance	VR2	X65-1380	CH1: GND Adjust VR2 so that the luminescent line does not vary when switching between 1 mV/DIV and 2 mV/DIV.
CH1 MAG Balance	VR3	X65-1380	CH1: GND Adjust VR3 so that the luminescent line does not vary when switching between 2 mV/DIV and 5 mV/DIV.
CH2 Step ATT Balance	VR52	X65-1380	V-MODE: CH2 CH2: GND Adjust VR52 so that the luminescent line does not vary when switching between 1 mV/DIV and 2 mV/DIV.
CH2 MAG Balance	VR53	X65-1380	V-MODE: CH2 CH2: GND Adjust VR53 so that the luminescent line does not vary when switching between 2 mV/DIV and 5 mV/DIV.
ADD Position	VR101	X65-1380	CH1,2: GND Bring the luminescent line to the center for both CH1 and CH2. Switch V-MODE to ADD and adjust VR101 so that the luminescent line comes to the center.
CH1 waveform shaping 10 mV 1 mV	VR5 VR4	X65-1380	Apply a 1 kHz square wave to CH1 INPUT (with the amplitude extending over 6 div.) Adjust so that CH1 ATT waveform is flat for both 10 mV/DIV and 1 mV/DIV ranges. 10 mV/DIV: VR5 1 mV/DIV: VR4 

ADJUSTMENT

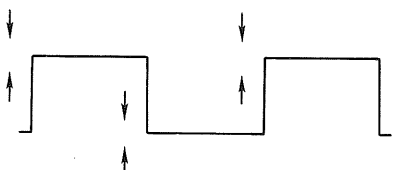
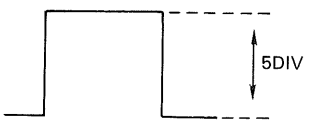
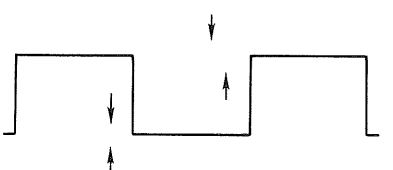
Item	Adjustment VR (TC)	P.C.B.	Procedure
CH2 waveform shaping 10 mV 1 mV	VR55 VR54	X65-1380	<p>Apply a 1kHz square wave to CH2 INPUT (with the amplitude extending over 6 div.) Adjust so that CH2 ATT waveform is flat for both 10 mV/DIV and 1 mV/DIV ranges.</p> <p>10 mV/DIV: VR55 1 mV/DIV: VR54</p> 
CH1 Gain	VR103	X65-1380	<p>Apply a 50 mV square wave to CH1 INPUT. Adjust VR103 so that amplitude extends over 5 divisions.</p> 
CH2 Gain	VR57	X65-1380	<p>V-MODE: CH2 Apply a 50 mV square wave to CH2 INPUT. Adjust VR57 so that amplitude extends over 5 divisions.</p>
X Gain	VR151	X65-1380	<p>CH1: GND MODE: X-Y Apply a 50 mV square wave to CH2 INPUT. Adjust VR151 so that horizontal amplitude extends over 5 divisions.</p>
CH1 waveform shaping	TC2 TC4	X65-1380	<p>Apply a 1kHz square wave to CH1 INPUT (with the amplitude extending over 6 div.) Adjust so that CH1 ATT waveform is flat for both 0.1 V/DIV and 1 V/DIV ranges.</p> <p>0.1 V/DIV: TC2 1 V/DIV: TC4</p> 
CH2 waveform shaping	TC52 TC54	X65-1380	<p>V-MODE: CH2 Apply a 1 kHz square wave to CH2 INPUT (with the amplitude extending over 6 div.) Adjust so that CH2 ATT waveform is flat for both 0.1 V/DIV and 1 V/DIV ranges.</p> <p>0.1 V/DIV: TC52 1 V/DIV: TC54</p>
CH1 input capacity	TC1 TC3	X65-1380	<p>Connect a capacity meter to CH1 INPUT. Check that the capacity value for the CH1 10 mV/DIV range is within the standard. (28pF +/- 3pF) Adjust so that the same capacity value for 10 mV/DIV is obtained in both 0.1 V/DIV and 1 V/DIV ranges.</p> <p>0.1 V/DIV: TC1 1 V/DIV: TC3</p>

ADJUSTMENT

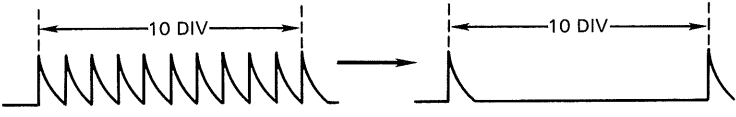
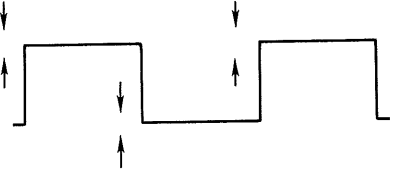
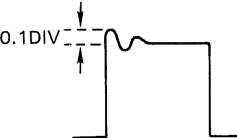
Item	Adjustment VR (TC)	P.C.B.	Procedure
CH2 input capacity	TC51 TC53	X65-1380	Connect a capacity meter to CH2 INPUT. Adjust in the same way as for CH1. 0.1 V/DIV: TC51 1 V/DIV: TC53
0.1 ms Sweep time	VR202	X65-1380	SWEEP TIME: 0.1 ms/DIV Input a 0.1 ms marker signal to CH1 INPUT. Adjust VR202 so that each marker peak aligns with a division on the scale.
2 ms Sweep time	VR201	X65-1380	SWEEP TIME: 2 ms/DIV Input a 2 ms marker signal to CH1 INPUT. Adjust VR201 so that each marker peak aligns with a division on the scale.
X10 MAG Gain	VR302	X65-1380	SWEEP TIME: 0.1 ms/DIV H.POSITION: Center Input a 0.1 ms marker signal to CH1 INPUT. Turn on X10 MAG and adjust VR302 so that there are 10 divisions on the scale between adjacent marker peaks. 
X10 MAG Center	VR303	X65-1380	SWEEP TIME: 0.1 ms/DIV Input a 0.5 ms marker signal to CH1 INPUT. With X10 MAG on, align the second peak with the center. Adjust VR303 so that the second peak remains aligned with the center when X10 MAG is turned off. Repeat several times to find the center.
X Position Center	VR152	X65-1380	CH1, 2: GND CH1, 2 POSITION: Center H-POSITION: Mechanical center MODE: X-Y Adjust VR152 so that the spot comes to the center
CH1, 2 1MHz square wave	TC101	X65-1380	Apply a 1 MHz square wave to CH1 (with the amplitude extending over 6 div.) Adjust with TC101 so that the waveform is flat. 
CH1 1 MHz overshoot	TC6	X65-1380	Apply a 1 MHz square wave to CH1 (with the amplitude extending over 6 div.) Adjust the overshoot with TC6. 
CH2 1 MHz overshoot	TC56	X65-1380	Apply a 1 MHz square wave to CH2 (with the amplitude extending over 6 div.) Adjust the overshoot with TC56.

ADJUSTMENT

POWER SUPPLY UNIT (X68-1570-00)

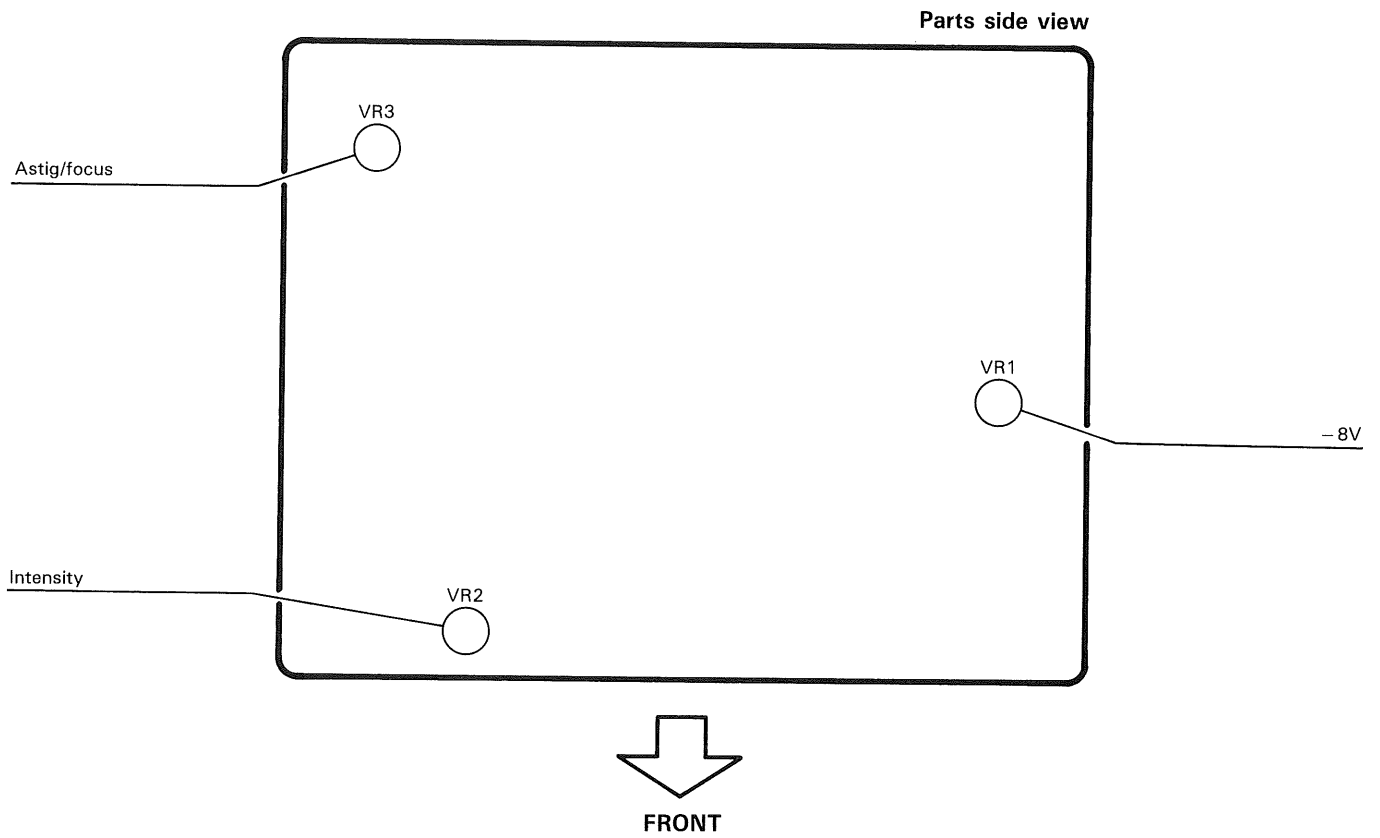

ADJUSTMENT

VERTICAL&HORIZONTAL UNIT (X65-1380-00)

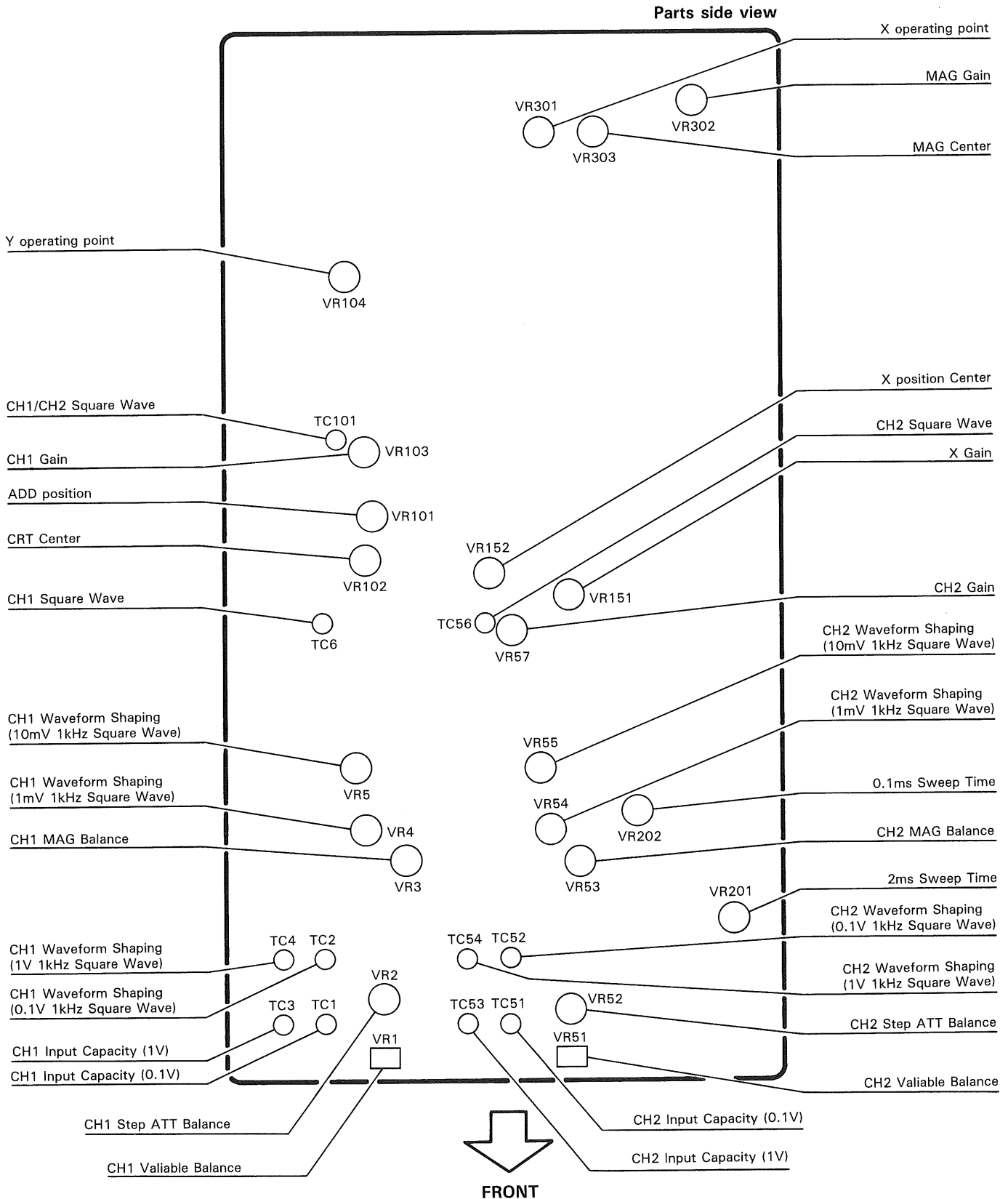

TROUBLESHOOTING

Note: When an index number in the form of "TP (number)" is found, refer to the corresponding location (e.g. figure of waveform, etc.) on the circuit diagram.

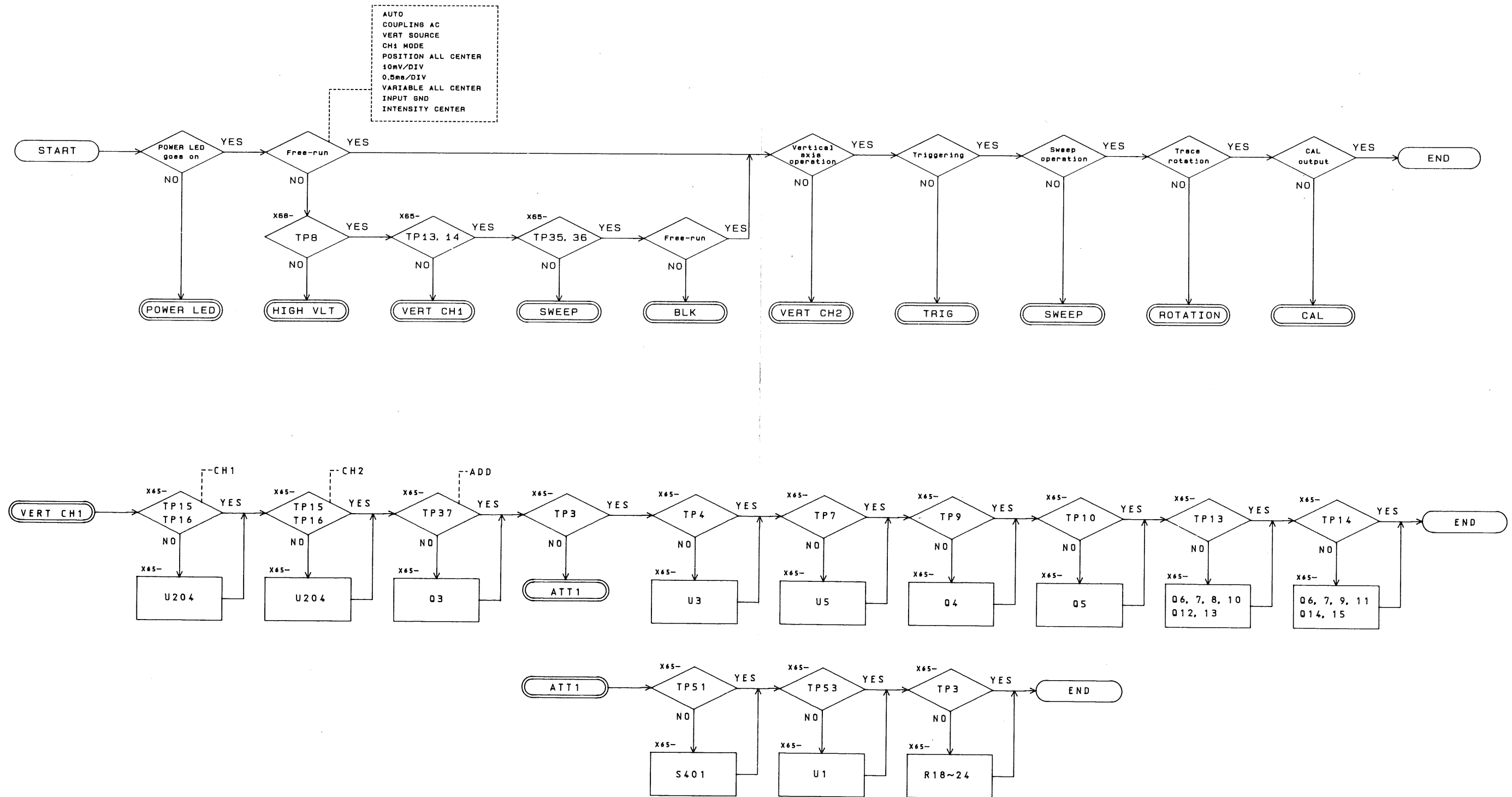

TROUBLESHOOTING

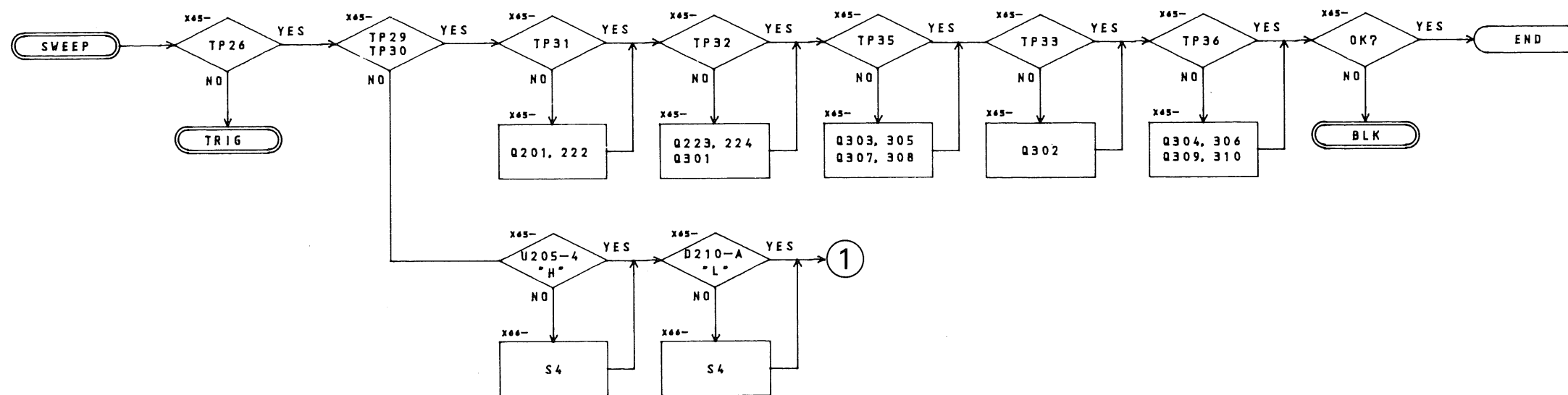
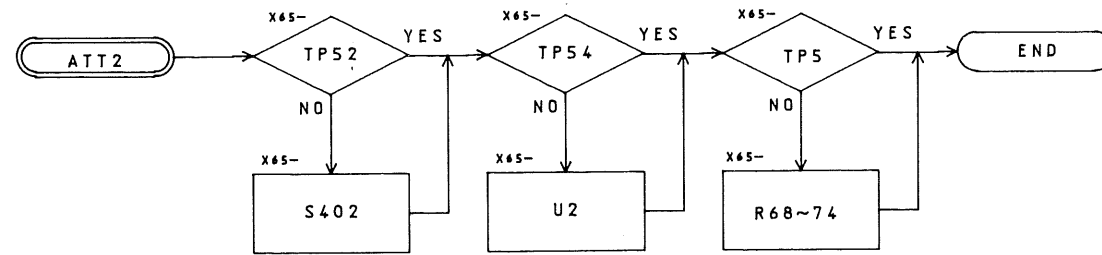
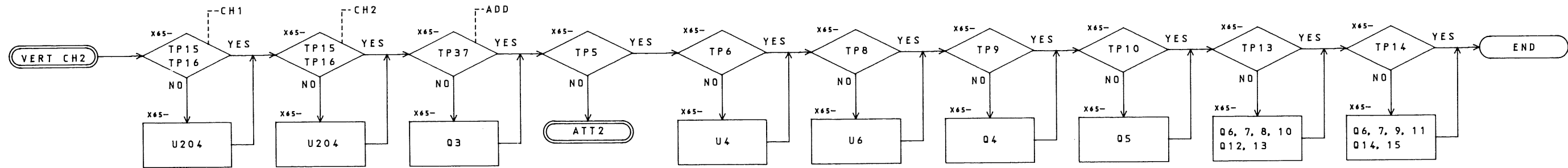

TROUBLESHOOTING

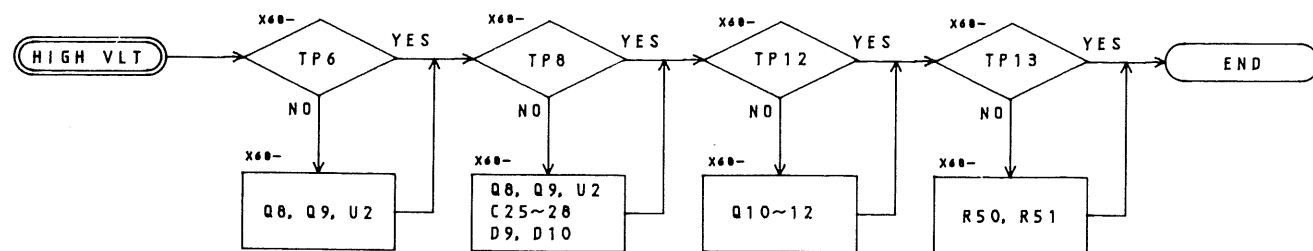
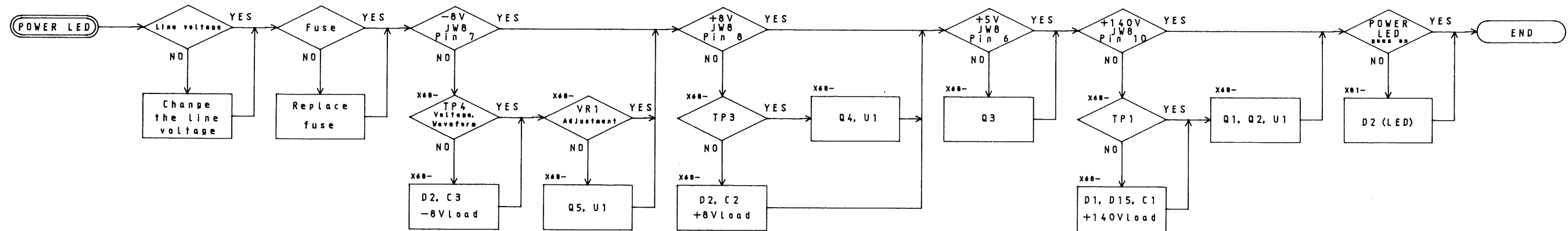
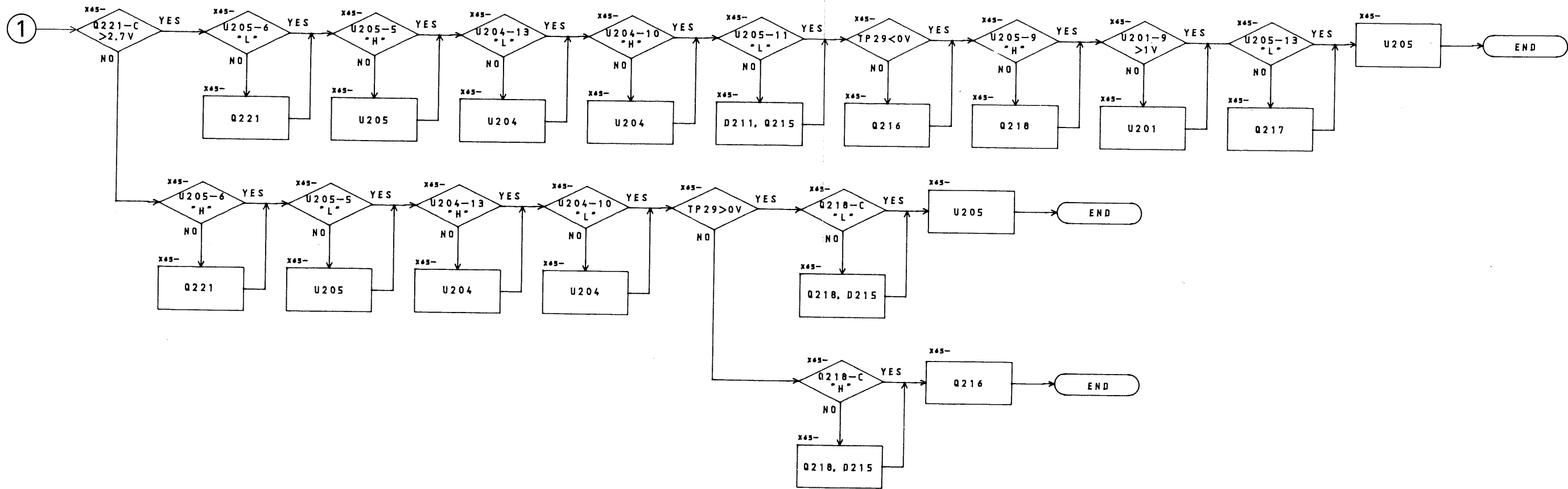

TROUBLESHOOTING

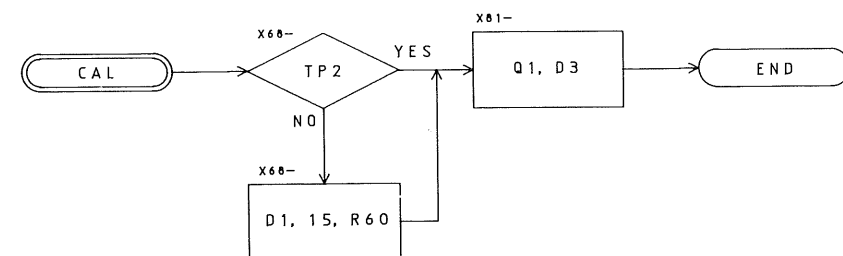
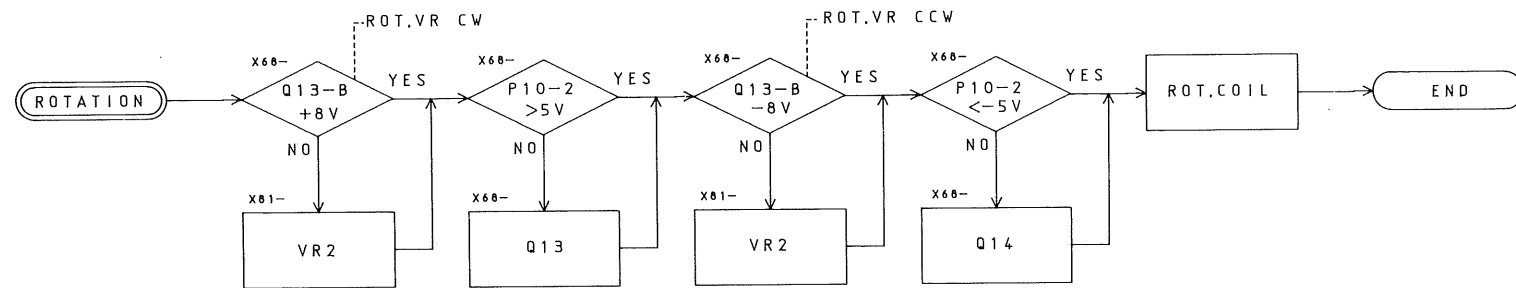
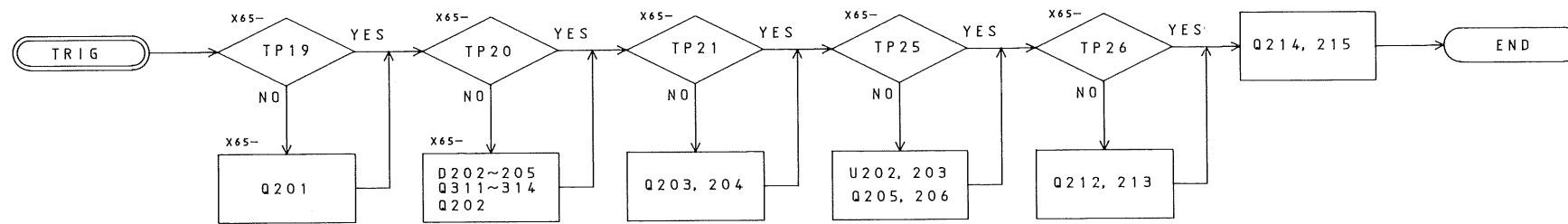
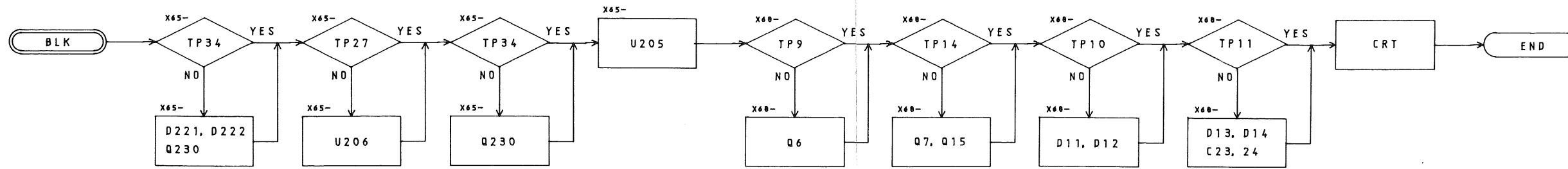

PARTS LIST

CS-4025

(Y70-1680-00)

REF.NO	PARTS NO	NAME & DESCRIPTION
	B42-3699-04	SERIAL NO. PLATE
	B50-7731-00	INSTRUCTION MANUAL, JAPANESE
	B50-7732-10	INSTRUCTION MANUAL, ENGLISH
*	E30-1818-05	JIS POWER CORD SET
	E30-1851-05	POWER CORD ASS'Y (JIS)
	E30-1852-05	POWER CORD ASS'Y (CEE)
	E30-1853-05	POWER CORD ASS'Y (SAA)
	E30-1854-05	POWER CORD ASS'Y (UL/CSA)
	E30-1868-05	POWER CORD ASS'Y (BS)
	E31-5878-05	WIRE ASS'Y: P14 TO Z AXIS /P14
	E31-5879-05	WIRE ASS'Y: CH1 OUTPUT TO P5
	E31-5880-05	WIRE ASS'Y: P. TRANS TO P16
	E31-5881-05	WIRE ASS'Y: POWER SW TO PRIMARY
	F05-5013-05	FUSE (6X30MM) 0.5A
	F05-5016-05	FUSE (5X20MM) 500MAT
	F05-8015-05	FUSE (6X30MM) 0.8A
	H01-5925-04	CARTON BOX
	H10-2848-02	FOAMED STYRENE PAD (FRONT)
	H10-2849-02	FOAMED STYRENE PAD (REAR)
	H20-1727-04	VINYL COVER
	H25-0103-04	BAG
	J19-1313-05	CLAMP
	J19-1653-23	HOLDER FOR CRT
	J42-0083-05	BUSHING
	J42-0085-05	BUSHING (FOR AC CORD)
	J61-0408-05	WIRE WRAPPING BAND
	J61-0514-05	WIRE TIE
	LN322GP	DIODE
	RD148B2C102J	RES. CARBON 1K 5% 1/4W
	W03-2314-05	PROBE (PC-35)
1	A01-1225-22	CASE
2	A10-1458-22	CHASSIS
3	A13-0946-12	FRAME
4	A13-0947-13	FRAME
5	A20-2847-21	MOLDED PANEL
6A	A23-1703-22	REAR PANEL
* 6B	A23-1704-22	REAR PANEL
7	A40-0715-03	BOTTOM PLATE
8	B11-0518-04	FILTER
9	E04-0259-05	BNC RECEPTACLE
10	E18-0365-05	AC SELECTOR WITH 6X30MM FUSE
11	E21-0660-04	TERMINAL, CAL
12	F11-1241-04	CRT SHIELD
13	F15-0757-04	FELT
14	G16-0609-04	RUBBER SHEET
15	J02-0089-05	RUBBER FOOT (REAR)
16	J02-0524-04	TILT STAND
17	J02-0525-13	RUBBER FOOT (FRONT)
18	J21-4695-03	BRACKET, FOR CRT
19	J21-4696-04	BRACKET, FOR POWER SW
20	J21-4737-04	BRACKET, FOR PANEL UNIT
21	K01-0518-05	HANDLE
22	K21-0892-03	KNOB (VOLTS/DIV)
23	K21-0897-14	KNOB
24	K21-0910-03	KNOB (SWEEP TIME/DIV)
25	K23-0811-03	KNOB
26	K27-0590-04	KNOB, FOR PUSH SW
27	K27-0537-04	KNOB, FOR LEVER SWITCH
28A	L01-9947-05	POWER TRANSFORMER
* 28B	L01-9948-05	POWER TRANSFORMER
29	L39-0531-05	ROTATION COIL
30	S40-2532-05	POWER SW
31	W01-0503-04	REAR RUBBER FOOT/CORD WRAP
32	X65-1380-00	VERTICAL & HORIZONTAL UNIT
33	X66-1100-00	PANEL UNIT
34	X68-1570-00	POWER SUPPLY UNIT
35A	X81-2810-00	CRT SOCKET UNIT (FUSE 6x30 mm)
35B	X81-2810-01	CRT SOCKET UNIT (FUSE 5x20 mm)
* 35C	X81-2810-02	CRT SOCKET UNIT
36A	150GTM31A	CRT
36B	150GTM7A	CRT

MODEL PC-35 (LOW CAPACITY PROBE)

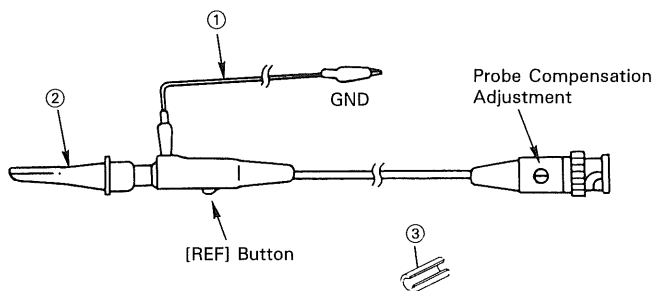

ITEM	DESCRIPTION	PARTS NO.
①	Ground Wire Assembly	E30-1883-08
②	Retractable Hook Tip	E29-0540-08
③	Marker (Orange)	B42-1950-08

The parts marked with an * are only for the units with a voltage selector.

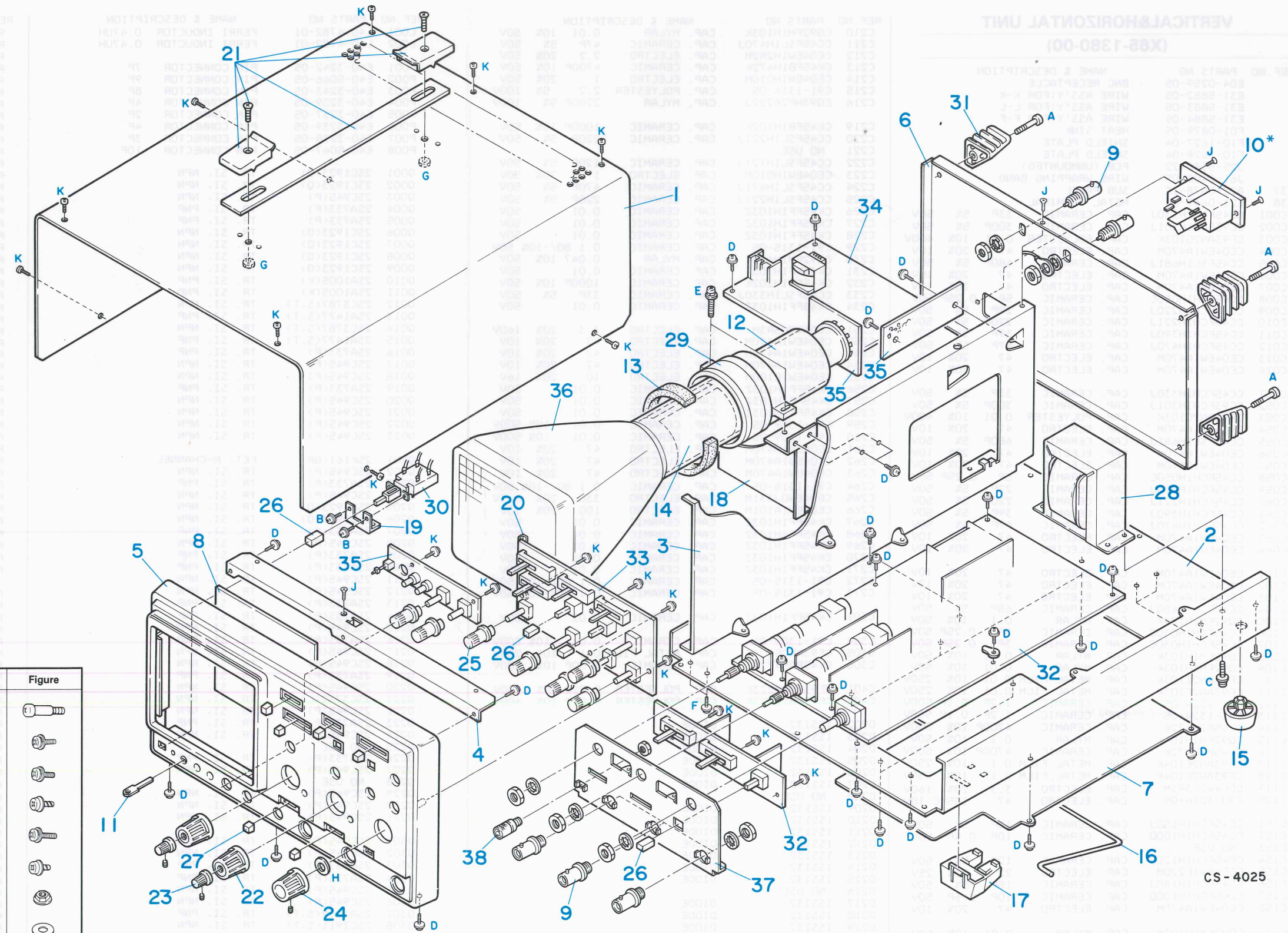

SCREWS

Parts No.	Parts Name	Figure
A N08-0611-04	Cord wrapping screw	
B N09-0623-04	Sems screw (M3 x 8)	
C N09-0654-05	Sems screw (M4 x 8)	
D N09-0739-05	Sems taptite screw (3 x 8)	
E N09-0748-04	Sems screw (M4 x 12)	
F N09-0757-05	Sems taptite screw (3 x 6)	
G N14-0620-05	Flange nut (M4)	
H N19-0709-05	Plain washer (t = 1, φ6)	
I N30-4014-41	Pan head screw (M4 x 14)	
J N88-3008-41	Flat head taptite screw (3 x 8)	
K N89-3008-41	Binding head taptite screw (3 x 8)	

CS - 4025

The parts marked with an * are only for the units with a voltage selector.

PARTS LIST

VERTICAL&HORIZONTAL UNIT (X65-1380-00)

REF.NO	PARTS NO	NAME & DESCRIPTION			
	E04-0259-05	BNC RECEPTACLE			
	E31-5882-05	WIRE ASS'Y:FOR K-K			
	E31-5883-05	WIRE ASS'Y:FOR L-L			
	E31-5884-05	WIRE ASS'Y:FOR F-F			
	F01-0879-05	HEAT SINK			
	F10-1627-04	SHIELD PLATE			
	F10-1628-04	SHIELD PLATE			
	J25-5390-22	PCB (UNMOUNTED)			
	J61-0408-05	WIRE WRAPPING BAND			
	A22-0878-13	SUB PANEL			
	E21-0667-05	METAL TERMINAL			
C001	CC45FCH1H330J	CAP. CERAMIC	33P	5%	50V
C002	CC93FCH1H301J	CAP. CERAMIC	300P	5%	50V
C003	CF93AN2G103K	CAP. POLYESTER	0.01	10%	400V
C004	CE04EW1A470M	CAP. ELECTRO	47	20%	10V
C005	CC45FSL1H681J	CAP. CERAMIC	680P	5%	50V
C006	CE04EW1A470M	CAP. ELECTRO	47	20%	10V
C007	CE04EW1A470M	CAP. ELECTRO	47	20%	10V
C008	CC45FCH1H050C	CAP. CERAMIC	5P	0.25P	50V
C009	CC45FCH1H220J	CAP. CERAMIC	22P	5%	50V
C010	CC45FCH1H221J	CAP. CERAMIC	220P	5%	50V
C011	CC45FCH1H390J	CAP. CERAMIC	39P	5%	50V
C012	CC45FCH1H470J	CAP. CERAMIC	47P	5%	50V
C013	CE04EW1A470M	CAP. ELECTRO	47	20%	10V
C014	CE04EW1A470M	CAP. ELECTRO	47	20%	10V
C051	CC45FCH1H330J	CAP. CERAMIC	33P	5%	50V
C052	CC93FCH1H301J	CAP. CERAMIC	300P	5%	50V
C053	CF93AN2G103K	CAP. POLYESTER	0.01	10%	400V
C054	CE04EW1A470M	CAP. ELECTRO	47	20%	10V
C055	CC45FSL1H681J	CAP. CERAMIC	680P	5%	50V
C056	CE04EW1A470M	CAP. ELECTRO	47	20%	10V
C057	CE04EW1A470M	CAP. ELECTRO	47	20%	10V
C058	CC45FCH1H050C	CAP. CERAMIC	5P	0.25P	50V
C059	CC45FCH1H220J	CAP. CERAMIC	22P	5%	50V
C060	CC45FCH1H221J	CAP. CERAMIC	220P	5%	50V
C061	CC45FCH1H390J	CAP. CERAMIC	39P	5%	50V
C062	CC45FCH1H470J	CAP. CERAMIC	47P	5%	50V
C063	CE04EW1A470M	CAP. ELECTRO	47	20%	10V
C064	CE04EW1A470M	CAP. ELECTRO	47	20%	10V
C101	CE04EW1A470M	CAP. ELECTRO	47	20%	10V
C102	CE04EW1A470M	CAP. ELECTRO	47	20%	10V
C103	CE04EW1A470M	CAP. ELECTRO	47	20%	10V
C104	CC45FCH1H680J	CAP. CERAMIC	68P	5%	50V
C105	C092FM1H104K	CAP. MYLAR	0.1	10%	50V
C106	CC45FCH1H030C	CAP. CERAMIC	3P	0.25P	50V
C107	CC45FCH1H030C	CAP. CERAMIC	3P	0.25P	50V
C108	C092FM1H103K	CAP. MYLAR	0.01	10%	50V
C109	C092FM1H103K	CAP. MYLAR	0.01	10%	50V
C110	CF93AN2E103K	CAP. METAL FILM	0.01	10%	250V
C111	CF93AN2E103K	CAP. METAL FILM	0.01	10%	250V
C112	C91-1324-05	CAP. CERAMIC	1.2P	0.1P	500V
C113	C91-1324-05	CAP. CERAMIC	1.2P	0.1P	500V
C114	CK45B2H472K	CAP. CERAMIC	4700P	10%	500V
C115	C092FM1H104K	CAP. MYLAR	0.1	10%	50V
C116	CK45B2H472K	CAP. CERAMIC	4700P	10%	500V
C117	CF93AN2E104K	CAP. METAL FILM	0.1	10%	250V
C118	CF93AN2E104K	CAP. METAL FILM	0.1	10%	250V
C119	CE04W2C3R3M	CAP. ELECTRO	3.3	20%	160V
C120	C90-3016-05	CAP. ELECTRO	47	105°C	10V
C151	CC45FCH1H150J	CAP. CERAMIC	15P	5%	50V
C152	CC45FCH1H100D	CAP. CERAMIC	10P	0.5P	50V
C153	NO USE				
C154	CC45FCH1H120J	CAP. CERAMIC	12P	5%	50V
C155	CE04BW1E220M	CAP. ELECTRO	22	20%	25V
C156	CC45FCH1H180J	CAP. CERAMIC	18P	5%	50V
C157	CC45FCH1H100D	CAP. CERAMIC	10P	0.5P	50V
C158	CE04EW1A470M	CAP. ELECTRO	47	20%	10V
C201	C092FM1H103K	CAP. MYLAR	0.01	10%	50V
C202	CE04BW1E220M	CAP. ELECTRO	22	20%	25V
C203	CE04EW1C100M	CAP. ELECTRO	10	20%	16V
C204	CC45FSL1H561J	CAP. CERAMIC	560P	5%	50V
C205	CK45FF1H103Z	CAP. CERAMIC	0.01	50V	
C206	CE04HW1H010M	CAP. ELECTRO	1	20%	50V
C207	NO USE				
C208	C092FM1H473K	CAP. MYLAR	0.047	10%	50V
C209	CC45SL1H020C	CAP. CERAMIC	2P	0.25P	50V

REF.NO	PARTS NO	NAME & DESCRIPTION			
C210	C092FM1H103K	CAP. MYLAR	0.01	10%	50V
C211	CC45FSL1H470J	CAP. CERAMIC	47P	5%	50V
C212	CE04EW1H2R2M	CAP. ELECTRO	2.2	20%	50V
C213	CK45FB1H472K	CAP. CERAMIC	4700P	10%	50V
C214	CE04EW1H010M	CAP. ELECTRO	1	20%	50V
C215	C91-1316-05	CAP. POLYESTER	2.2	5%	100V
C216	C093HP2A222J	CAP. MYLAR	2200P	5%	100V
C219	CK45FB1H102K	CAP. CERAMIC	1000P	10%	50V
C220	CC45FSL1H221J	CAP. CERAMIC	220P	5%	50V
C221	NO USE				
C222	CC45FSL1H121J	CAP. CERAMIC	120P	5%	50V
C223	CE04EW1H010M	CAP. ELECTRO	1	20%	50V
C224	CC45FSL1H471J	CAP. CERAMIC	470P	5%	50V
C225	CC45FSL1H221J	CAP. CERAMIC	220P	5%	50V
C226	CK45FF1H103Z	CAP. CERAMIC	0.01	50V	
C227	CK45FF1H103Z	CAP. CERAMIC	0.01	50V	
C228	CK45FF1H103Z	CAP. CERAMIC	0.01	50V	
C229	C91-1315-05	CAP. CERAMIC	0.1	80/-10%	50V
C230	C092FM1H473K	CAP. MYLAR	0.047	10%	50V
C231	CK45FF1H103Z	CAP. CERAMIC	0.01	50V	
C232	CK45FB1H102K	CAP. CERAMIC	1000P	10%	50V
C233	CC45FSL1H330J	CAP. CERAMIC	33P	5%	50V
C234	CK45FF1H103Z	CAP. CERAMIC	0.01	50V	
C251	CE04W2C3R3M	CAP. ELECTRO	3.3	20%	160V
C252	CE04EW1A470M	CAP. ELECTRO	47	20%	10V
C253	CE04EW1A470M	CAP. ELECTRO	47	20%	10V
C254	CE04EW1A470M	CAP. ELECTRO	47	20%	10V
C255	CE04EW1C100M	CAP. ELECTRO	10	20%	16V
C256	CK45FF1H103Z	CAP. CERAMIC	0.01	50V	
C257	CK45FF1H103Z	CAP. CERAMIC	0.01	50V	
C258	CK45FF1H103Z	CAP. CERAMIC	0.01	50V	
C259	C91-1309-05	CAP. CERAMIC	0.01	10%	500V
C260	C91-1309-05	CAP. CERAMIC	0.01	10%	500V
C261	CE04EW1A470M	CAP. ELECTRO	47	20%	10V
C262	CE04EW1A470M	CAP. ELECTRO	47	20%	10V
C263	CE04EW1A470M	CAP. ELECTRO	47	20%	10V
C264	C91-1315-05	CAP. CERAMIC	0.1	80/-10%	50V
C265	CE04EWOJ331M	CAP. ELECTRO	330	20%	6.3V
C266	CE04EW1A101M	CAP. ELECTRO	100	20%	10V
C267	CK45FF1H103Z	CAP. CERAMIC	0.01	50V	
C268	CK45FF1H103Z	CAP. CERAMIC	0.01	50V	
C269	CK45FF1H103Z	CAP. CERAMIC	0.01	50V	
C270	CK45FF1H103Z	CAP. CERAMIC	0.01	50V	
C271	CK45FF1H103Z	CAP. CERAMIC	0.01	50V	
C272	C91-1315-05	CAP. CERAMIC	0.1	80/-10%	50V
C273	C91-1315-05	CAP. CERAMIC	0.1	80/-10%	50V
C301	CK45FF1H103Z	CAP. CERAMIC	0.01	50V	
C304	C91-1309-05	CAP. CERAMIC	0.01	10%	500V
C305	CF93AN2E104K	CAP. METAL FILM	0.1	10%	250V
C306	CK45B2H472K	CAP. CERAMIC	4700P	10%	500V
C401	CF93AN2G223K	CAP. POLYESTER	0.022	10%	400V
C402	CF93AN2G223K	CAP. POLYESTER	0.022	10%	400V
D202	1SS132	DIODE			
D203	1SS132	DIODE			
D204	1SS132	DIODE			
D205	1SS132	DIODE			
D206	1SS132	DIODE			
D207	1SS132	DIODE			
D208	NO USE				
D209	1SS132	DIODE			
D210	1SS132	DIODE			
D211	1SS132	DIODE			
D212	1SS132	DIODE			
D213	1SS132	DIODE			
D214	1SS132	DIODE			
D215	1SS132	DIODE			
D216	NO USE				
D217	1SS132	DIODE			
D218	1SS132	DIODE			
D219	1SS132	DIODE			
D220	1SS132	DIODE			
D221	MA700	DIODE			
D222	1SS132	DIODE			
D301	1SS83	DIODE			
D302	1SS83	DIODE			
D303	MA700	DIODE			
D304	1SS132	DIODE			

REF.NO	PARTS NO	NAME & DESCRIPTION			
L001	L40-4782-01	FERRI INDUCTOR	0.47UH		
L002	L40-4782-01	FERRI INDUCTOR	0.47UH		
P001	E40-3242-05	PIN CONNECTOR	7P		
P002	E40-5066-05	PIN CONNECTOR	9P		
P003	E40-3243-05	PIN CONNECTOR	8P		
P004	E40-3239-05	PIN CONNECTOR	4P		
P005	E40-3237-05	PIN CONNECTOR	2P		
P006	E40-3239-05	PIN CONNECTOR	4P		
P007	E40-3238-05	PIN CONNECTOR	3P		
P008	E40-5067-05	PIN CONNECTOR	10P		
0001	25C1923(O)	TR. SI. NPN			
0002	25C1923(O)	TR. SI. NPN			
0003	25C945(P)	TR. SI. NPN			
0004	25A733(P)	TR. SI. PNP			
0005	25A733(P)	TR. SI. PNP			
0006	25C1923(O)	TR. SI. NPN			
0007	25C1923(O)	TR. SI. NPN			
0008	25C1923(O)	TR. SI. NPN			
0009	25C1923(O)	TR. SI. NPN			
0010	25A1005(K)	TR. SI. PNP			
0011	25A1005(K)	TR. SI. PNP			
0012	25C3787(S.T)	TR. SI. NPN			
0013	25A1477(S.T)	TR. SI. PNP			
0014	25C3787(S.T)	TR. SI. NPN			
0015	25A1477(S.T)	TR. SI. PNP			
0016	25A733(P)	TR. SI. PNP			
0017	25C945(P)	TR. SI. NPN			
0018	25C945(P)	TR. SI. NPN			
0019	25A733(P)	TR. SI. PNP			
0020	25C945(P)	TR. SI. NPN			
0021	25C945(P)	TR. SI. NPN			
0022	25C945(P)	TR. SI. NPN			
0023	25C945(P)	TR. SI. NPN			
0201	25K161(GR)	FET, N-CHANNEL			
0202	25C945(P)	TR. SI. NPN			
0203	25A733(P)	TR. SI. PNP			
0204	25C945(P)	TR. SI. NPN			
0205	25C1923(O)	TR. SI. NPN			
0206	25C1923(O)	TR. SI. NPN			
0207	25A733(P)	TR. SI. PNP			
0208	25C945(P)	TR. SI. NPN			
0209	25A733(P)	TR. SI. PNP			
0210	25A733(P)	TR. SI. PNP			
0211	25C945(P)	TR. SI. NPN			
0212	25C945(P)	TR. SI. NPN			
0213	25A733(P)	TR. SI. PNP			
0214	25A733(P)	TR. SI. PNP			
0215	25C945(P)	TR. SI. NPN			
0216	25A733(P)	TR. SI. PNP			
0217	25C945(P)	TR. SI. NPN			
0218	25C945(P)	TR. SI. NPN			
0219	25A733(P)	TR. SI. PNP			
0220	25C945(P)	TR. SI. NPN			
0221	25C3732(L)	TR. SI. NPN			
0222	25C945(P)	TR. SI. NPN			
0223	25A733(P)	TR. SI. PNP			
0224	25C945(P)	TR. SI. NPN			
0225	NO USE				
0226	25A733(P)	TR. SI. PNP			
0227	25C945(P)	TR. SI. NPN			
0228	NO USE				
0229	25C945(P)	TR. SI. NPN			
0230	25C945(P)	TR. SI. NPN			
0231	25C945(P)	TR. SI. NPN			
0301	25C945(P)	TR. SI. NPN			
0302	25C945(P)	TR. SI. NPN			
0303	25A733(P)	TR. SI. PNP			
0304	25A733(P)	TR. SI. PNP			

PARTS LIST

REF.NO	PARTS NO	NAME & DESCRIPTION	REF.NO	PARTS NO	NAME & DESCRIPTION
R089	RD148B2C183J	RES. CARBON 18K 5% 1/6W	R178	RD148B2C152J	RES. CARBON 1.5K 5% 1/6W
R090	RD148B2C102J	RES. CARBON 1K 5% 1/6W	R179	RD148B2C392J	RES. CARBON 3.9K 5% 1/6W
R091	RD148B2C221J	RES. CARBON 220 5% 1/6W	R180	RD148B2C220J	RES. CARBON 22 5% 1/6W
R092	NO USE		R181	RD148B2C392J	RES. CARBON 3.9K 5% 1/6W
R093	RD148B2C681J	RES. CARBON 680 5% 1/6W	R182	RD148B2C821J	RES. CARBON 820 5% 1/6W
R094	RD148B2C104J	RES. CARBON 100K 5% 1/6W	R183	RD148B2C163J	RES. CARBON 16K 5% 1/6W
R095	RD148B2C100J	RES. CARBON 10 5% 1/6W	R184	RD148B2C220J	RES. CARBON 22 5% 1/6W
R096	RD148B2C101J	RES. CARBON 100 5% 1/6W	R185	RD148B2C132J	RES. CARBON 1.3K 5% 1/6W
R101	RD148B2C223J	RES. CARBON 22K 5% 1/6W	R201	RD148B2C105J	RES. CARBON 1M 5% 1/6W
R102	RN148K2C6200F	RES. METAL FILM 620 1% 1/6W	R202	RD148B2C104J	RES. CARBON 100K 5% 1/6W
R103	RN148K2C8200F	RES. METAL FILM 820 1% 1/6W	R203	RD148B2C182J	RES. CARBON 1.8K 5% 1/6W
R104	RN148K2C8200F	RES. METAL FILM 820 1% 1/6W	R204	RD148B2C162J	RES. CARBON 1.6K 5% 1/6W
R105	RD148B2C103J	RES. CARBON 10K 5% 1/6W	R205	RD148B2C302J	RES. CARBON 3K 5% 1/6W
R106	RN148K2C1001F	RES. METAL FILM 1K 1% 1/6W	R206	RD148B2C272J	RES. CARBON 2.7K 5% 1/6W
R107	RN148K2C1001F	RES. METAL FILM 1K 1% 1/6W	R207	RD148B2C562J	RES. CARBON 5.6K 5% 1/6W
R108	RN148K2C6201F	RES. METAL FILM 6.2K 1% 1/6W	R208	RD148B2C102J	RES. CARBON 1K 5% 1/6W
R109	RN148K2C6201F	RES. METAL FILM 6.2K 1% 1/6W	R209	RD148B2C472J	RES. CARBON 4.7K 5% 1/6W
R110	RN148K2C9100F	RES. METAL FILM 910 1% 1/6W	R210	RD148B2C472J	RES. CARBON 4.7K 5% 1/6W
R111	RN148K2C9100F	RES. METAL FILM 910 1% 1/6W	R211	RD148B2C242J	RES. CARBON 2.4K 5% 1/6W
R112	RD148B2C470J	RES. CARBON 47 5% 1/6W	R212	RD148B2C272J	RES. CARBON 2.7K 5% 1/6W
R113	RD148B2C470J	RES. CARBON 47 5% 1/6W	R213	RD148B2C102J	RES. CARBON 1K 5% 1/6W
R114	RN148K2C1801F	RES. METAL FILM 1.8K 1% 1/6W	R214	RD148B2C153J	RES. CARBON 15K 5% 1/6W
R115	RN148K2C1801F	RES. METAL FILM 1.8K 1% 1/6W	R215	NO USE	
R116	RD148B2C911J	RES. CARBON 910 5% 1/6W	R216	RD148B2C472J	RES. CARBON 4.7K 5% 1/6W
R117	RD148B2C241J	RES. CARBON 240 5% 1/6W	R217	RD148B2C392J	RES. CARBON 3.9K 5% 1/6W
R118	RD148B2C221J	RES. CARBON 220 5% 1/6W	R218	RD148B2C103J	RES. CARBON 10K 5% 1/6W
R119	RN148K2C3901F	RES. METAL FILM 3.9K 1% 1/6W	R219	RD148B2C101J	RES. CARBON 100 5% 1/6W
R120	RN148K2C3901F	RES. METAL FILM 3.9K 1% 1/6W	R220	RD148B2C101J	RES. CARBON 100 5% 1/6W
R121	RD148B2C101J	RES. CARBON 100 5% 1/6W	R221	RD148B2C473J	RES. CARBON 47K 5% 1/6W
R122	RD148B2C101J	RES. CARBON 100 5% 1/6W	R222	RD148B2C333J	RES. CARBON 33K 5% 1/6W
R123	RD148B2C470J	RES. CARBON 47 5% 1/6W	R223	RD148B2C392J	RES. CARBON 3.9K 5% 1/6W
R124	RD148B2C470J	RES. CARBON 47 5% 1/6W	R224	RD148B2C102J	RES. CARBON 1K 5% 1/6W
R125	RD148B2C471J	RES. CARBON 470 5% 1/6W	R225	RD148B2C392J	RES. CARBON 3.9K 5% 1/6W
R126	RD148B2C471J	RES. CARBON 470 5% 1/6W	R226	RD148B2C221J	RES. CARBON 220 5% 1/6W
R127	RD148B2C220J	RES. CARBON 22 5% 1/6W	R227	RD148B2C473J	RES. CARBON 47K 5% 1/6W
R128	RD148B2C220J	RES. CARBON 22 5% 1/6W	R228	RD148B2C562J	RES. CARBON 5.6K 5% 1/6W
R129	RD148B2C471J	RES. CARBON 470 5% 1/6W	R229	RD148B2C105J	RES. CARBON 1M 5% 1/6W
R130	RD148B2C471J	RES. CARBON 470 5% 1/6W	R230	RD148B2C103J	RES. CARBON 10K 5% 1/6W
R131	RN148K2C1100F	RES. METAL FILM 110 1% 1/6W	R231	RD148B2C103J	RES. CARBON 10K 5% 1/6W
R132	RN148K2C1100F	RES. METAL FILM 110 1% 1/6W	R232	RD148B2C103J	RES. CARBON 10K 5% 1/6W
R133	RD148B2C220J	RES. CARBON 22 5% 1/6W	R233	RD148B2C101J	RES. CARBON 100 5% 1/6W
R134	RD148B3A223J	RES. CARBON 22K 5% 1W	R234	RD148B2C102J	RES. CARBON 1K 5% 1/6W
R135	RD148B3A223J	RES. CARBON 22K 5% 1W	R235	RD148B2C101J	RES. CARBON 100 5% 1/6W
R136	RN148K2C3002F	RES. METAL FILM 30K 1% 1/6W	R236	RD148B2C473J	RES. CARBON 47K 5% 1/6W
R137	RN148K2C1003F	RES. METAL FILM 100K 1% 1/6W	R237	RD148B2C821J	RES. CARBON 820 5% 1/6W
R138	RD148B3D122J	RES. CARBON 1.2K 5% 2W	R238	RD148B2C393J	RES. CARBON 39K 5% 1/6W
R139	RD148B3A183J	RES. CARBON 18K 5% 1W	R239	RD148B2C103J	RES. CARBON 10K 5% 1/6W
R140	RN148K2C3002F	RES. METAL FILM 30K 1% 1/6W	R240	RD148B2C103J	RES. CARBON 10K 5% 1/6W
R141	RN148K2C1003F	RES. METAL FILM 100K 1% 1/6W	R241	RD148B2C223J	RES. CARBON 22K 5% 1/6W
R142	RD148B3D122J	RES. CARBON 1.2K 5% 2W	R242	RD148B2C102J	RES. CARBON 1K 5% 1/6W
R143	RD148B3A183J	RES. CARBON 18K 5% 1W	R243	RD148B2C103J	RES. CARBON 10K 5% 1/6W
R144	RD148B2C220J	RES. CARBON 22 5% 1/6W	R244	RD148B2C103J	RES. CARBON 10K 5% 1/6W
R145	RD148B2C220J	RES. CARBON 22 5% 1/6W	R245	RD148B2C104J	RES. CARBON 100K 5% 1/6W
R146	RD148B2C100J	RES. CARBON 10 5% 1/6W	R246	RD148B2C104J	RES. CARBON 100K 5% 1/6W
R147	RD148B2C221J	RES. CARBON 220 5% 1/6W	R247	RD148B2C472J	RES. CARBON 4.7K 5% 1/6W
R148	RD148B2C221J	RES. CARBON 220 5% 1/6W	R248	RD148B2C163J	RES. CARBON 16K 5% 1/6W
R151	RD148B2C182J	RES. CARBON 1.8K 5% 1/6W	R249	RD148B2C513J	RES. CARBON 51K 5% 1/6W
R152	RD148B2C822J	RES. CARBON 8.2K 5% 1/6W	R250	RD148B2C302J	RES. CARBON 3K 5% 1/6W
R153	NO USE		R251	RD148B2C472J	RES. CARBON 4.7K 5% 1/6W
R154	RD148B2C362J	RES. CARBON 3.6K 5% 1/6W	R252	RD148B2C362J	RES. CARBON 3.6K 5% 1/6W
R155	RD148B2C132J	RES. CARBON 1.3K 5% 1/6W	R253	RD148B2C102J	RES. CARBON 1K 5% 1/6W
R156	RD148B2C470J	RES. CARBON 47 5% 1/6W	R254	RD148B2C472J	RES. CARBON 4.7K 5% 1/6W
R157	RD148B2C220J	RES. CARBON 22 5% 1/6W	R255	RD148B2C102J	RES. CARBON 1K 5% 1/6W
R158	NO USE		R256	RD148B2C122J	RES. CARBON 1.2K 5% 1/6W
R159	RD148B2C163J	RES. CARBON 16K 5% 1/6W	R257	RD148B2C103J	RES. CARBON 10K 5% 1/6W
R160	RD148B2C102J	RES. CARBON 1K 5% 1/6W	R258	RD148B2C203J	RES. CARBON 20K 5% 1/6W
R161	RD148B2C101J	RES. CARBON 100 5% 1/6W	R259	RD148B2C201J	RES. CARBON 200 5% 1/6W
R162	RD148B2C102J	RES. CARBON 1K 5% 1/6W	R260	RD148B2C472J	RES. CARBON 4.7K 5% 1/6W
R163	NO USE		R261	RD148B2C512J	RES. CARBON 51K 5% 1/6W
R164	RD148B2C102J	RES. CARBON 1K 5% 1/6W	R262	RD148B2C511J	RES. CARBON 510 5% 1/6W
R165	RD148B2C470J	RES. CARBON 47 5% 1/6W	R263	RD148B2C104J	RES. CARBON 100K 5% 1/6W
R166	RD148B2C104J	RES. CARBON 100K 5% 1/6W	R264	RD148B2C222J	RES. CARBON 2.2K 5% 1/6W
R167	RD148B2C182J	RES. CARBON 1.8K 5% 1/6W	R265	RD148B2C272J	RES. CARBON 2.7K 5% 1/6W
R168	RD148B2C822J	RES. CARBON 8.2K 5% 1/6W	R266	NO USE	
R169	NO USE		R267	RD148B2C104J	RES. CARBON 100K 5% 1/6W
R170	RD148B2C362J	RES. CARBON 3.6K 5% 1/6W	R268	RD148B2C222J	RES. CARBON 2.2K 5% 1/6W
R171	RD148B2C132J	RES. CARBON 1.3K 5% 1/6W	R269	NO USE	
R172	RD148B2C470J	RES. CARBON 47 5% 1/6W	R270	RD148B2C432J	RES. CARBON 4.3K 5% 1/6W
R173	RD148B2C220J	RES. CARBON 22 5% 1/6W	R271	NO USE	
R174	NO USE		R272	RD148B2C101J	RES. CARBON 100 5% 1/6W
R175	RD148B2C163J	RES. CARBON 16K 5% 1/6W	R273	NO USE	
R176	RD148B2C102J	RES. CARBON 1K 5% 1/6W	R274	RD148B2C222J	RES. CARBON 2.2K 5% 1/6W
R177	RD148B2C272J	RES. CARBON 2.7K 5% 1/6W	R275	RD148B2C823J	RES. CARBON 82K 5% 1/6W
			R276	RD148B2C472J	RES. CARBON 4.7K 5% 1/6W

PARTS LIST

REF.NO	PARTS NO	NAME & DESCRIPTION			
R277	RD148B2C122J	RES. CARBON	1.2K	5%	1/6W
R278	RD148B2C122J	RES. CARBON	1.2K	5%	1/6W
R279	RD148B2C103J	RES. CARBON	10K	5%	1/6W
R280	RD148B2C472J	RES. CARBON	4.7K	5%	1/6W
R281	RD148B2C101J	RES. CARBON	100	5%	1/6W
R282	RD148B2C302J	RES. CARBON	3K	5%	1/6W
R283	RD148B2C332J	RES. CARBON	3.3K	5%	1/6W
R284	RD148B2C103J	RES. CARBON	10K	5%	1/6W
R285	RD148B2C220J	RES. CARBON	22	5%	1/6W
R286	RD148B2C103J	RES. CARBON	10K	5%	1/6W
R287	RD148B2C112J	RES. CARBON	1.1K	5%	1/6W
R288	RD148B2C221J	RES. CARBON	220	5%	1/6W
R289	RD148B2C103J	RES. CARBON	10K	5%	1/6W
R290	RD148B2C472J	RES. CARBON	4.7K	5%	1/6W
R291	RD148B2C472J	RES. CARBON	4.7K	5%	1/6W
R292	RD148B2C272J	RES. CARBON	2.7K	5%	1/6W
R301	RD148B2C220J	RES. CARBON	22	5%	1/6W
R302	RD148B2C622J	RES. CARBON	6.2K	5%	1/6W
R303	RD148B2C220J	RES. CARBON	22	5%	1/6W
R304	RD148B2C562J	RES. CARBON	5.6K	5%	1/6W
R305	RD148B2C622J	RES. CARBON	6.2K	5%	1/6W
R306	RD148B2C220J	RES. CARBON	22	5%	1/6W
R307	RD148B2C622J	RES. CARBON	6.2K	5%	1/6W
R308	RD148B2C220J	RES. CARBON	22	5%	1/6W
R309	RD148B2C101J	RES. CARBON	100	5%	1/6W
R310	RD148B2C304J	RES. CARBON	300K	5%	1/6W
R311	RD148B2C223J	RES. CARBON	22K	5%	1/6W
R312	NO USE				
R313	RD148B2C101J	RES. CARBON	100	5%	1/6W
R314	RD148B2C121J	RES. CARBON	120	5%	1/6W
R315	NO USE				
R316	RD148B2C362J	RES. CARBON	3.6K	5%	1/6W
R317	RD148B2C222J	RES. CARBON	2.2K	5%	1/6W
R318	RD148B2C222J	RES. CARBON	2.2K	5%	1/6W
R319	RD148B2C332J	RES. CARBON	3.3K	5%	1/6W
R320	RD148B2C823J	RES. CARBON	82K	5%	1/6W
R321	RD148B2C103J	RES. CARBON	10K	5%	1/6W
R322	RD148B2C332J	RES. CARBON	3.3K	5%	1/6W
R323	RD148B2C823J	RES. CARBON	82K	5%	1/6W
R324	RD148B2C103J	RES. CARBON	10K	5%	1/6W
R325	RD148B2C562J	RES. CARBON	5.6K	5%	1/6W
R326	RD148B2C164J	RES. CARBON	160K	5%	1/6W
R327	RD148B2E202J	RES. CARBON	2K	5%	1/4W
R328	RD148B2C562J	RES. CARBON	5.6K	5%	1/6W
R329	RD148B2C164J	RES. CARBON	160K	5%	1/6W
R330	RD148B2E102J	RES. CARBON	1K	5%	1/4W
R334	RD148B2C470J	RES. CARBON	47	5%	1/6W
R335	RD148B2C470J	RES. CARBON	47	5%	1/6W
R336	RD148B2E432J	RES. CARBON	4.3K	5%	1/4W
R337	RD148B2C622J	RES. CARBON	6.2K	5%	1/6W
R341	R90-0281-05	RES. MULTIPLE	6X10K		
R342	R90-0229-05	RES. MULTIPLE	8X10K		
R343	RD148B2C473J	RES. CARBON	47K	5%	1/6W
R344	RD148B2C433J	RES. CARBON	43K	5%	1/6W
R345	RD148B2C433J	RES. CARBON	43K	5%	1/6W
R346	RD148B2C512J	RES. CARBON	5.1K	5%	1/6W
R347	RD148B2C512J	RES. CARBON	5.1K	5%	1/6W
R348	RD148B2C512J	RES. CARBON	5.1K	5%	1/6W
R401	RD148B2E105J	RES. CARBON	1M	5%	1/4W
R402	RD148B2E105J	RES. CARBON	1M	5%	1/4W
R403	RD148B2C220J	RES. CARBON	22	5%	1/6W
R404	RD148B2C220J	RES. CARBON	22	5%	1/6W
R405	RD148B2C220J	RES. CARBON	22	5%	1/6W
R406	RD148B2C220J	RES. CARBON	22	5%	1/6W
R407	RD148B2C220J	RES. CARBON	22	5%	1/6W
S001	S03-5501-05	ROTARY SWITCH			
S002	S03-5501-05	ROTARY SWITCH			
S201	S01-2516-05	ROTARY SWITCH			
S401	S31-1509-05	SLIDE SWITCH			
S402	S31-1509-05	SLIDE SWITCH			
S403	S40-1532-05	PUSH SWITCH			
TC001	C05-0031-15	CAP. TRIMMER	10P		
TC002	C05-0308-05	CAP. TRIMMER	4P		
TC003	C05-0031-15	CAP. TRIMMER	10P		
TC004	C05-0308-05	CAP. TRIMMER	4P		
TC005	NO USE				
TC006	C05-0469-05	CAP. TRIMMER	10P		

REF.NO	PARTS NO	NAME & DESCRIPTION			
TC051	C05-0031-15	CAP. TRIMMER	10P		
TC052	C05-0308-05	CAP. TRIMMER	4P		
TC053	C05-0031-15	CAP. TRIMMER	10P		
TC054	C05-0308-05	CAP. TRIMMER	4P		
TC055	NO USE				
TC056	C05-0469-05	CAP. TRIMMER	10P		
TC101	C05-0471-05	CAP. TRIMMER	30P		
U001	UPA68H(L)	FET, N-CHANNEL	DUAL		
U002	UPA68H(L)	FET, N-CHANNEL	DUAL		
U003	KMCO1	IC, LINEAR			
U004	KMCO1	IC, LINEAR			
U005	KMCO2	IC, LINEAR			
U006	KMCO2	IC, LINEAR			
U201	KMD02	IC, LINEAR			
U202	SN74LS86AN	IC, QUAD 2 INPUT EX-OR			
U203	SN74LS51N	IC, AND-OR-INVERT GATE			
U204	SN74LS74AN	IC, D-FLIP FLOP			
U205	SN74LS00N	IC, QUAD 2 INPUT NAND			
U206	SN74LS00N	IC, QUAD 2 INPUT NAND			
VR001	R12-3554-05	RES. SEMI FIXED	20KB		
VR002	R12-3550-05	RES. SEMI FIXED	20K B		
VR003	R12-3549-05	RES. SEMI FIXED	10K B		
VR004	R12-0572-05	RES. SEMI FIXED	100B		
VR005	R12-0572-05	RES. SEMI FIXED	100B		
VR051	R12-3554-05	RES. SEMI FIXED	20KB		
VR052	R12-3550-05	RES. SEMI FIXED	20K B		
VR053	R12-3549-05	RES. SEMI FIXED	10K B		
VR054	R12-0572-05	RES. SEMI FIXED	100B		
VR055	R12-0572-05	RES. SEMI FIXED	100B		
VR056	NO USE				
VR057	R12-0577-05	RES. SEMI FIXED	500 B		
VR101	R12-0576-05	RES. SEMI FIXED	200 B		
VR102	R12-3549-05	RES. SEMI FIXED	10K B		
VR103	R12-1545-05	RES. SEMI FIXED	1K B		
VR104	R12-0572-05	RES. SEMI FIXED	100B		
VR151	R12-0577-05	RES. SEMI FIXED	500 B		
VR152	R12-3549-05	RES. SEMI FIXED	10K B		
VR201	R12-2522-05	RES. SEMI FIXED	5K B		
VR202	R12-1543-05	RES. SEMI FIXED	1KB		
VR301	R12-2522-05	RES. SEMI FIXED	5K B		
VR302	R12-0572-05	RES. SEMI FIXED	100B		
VR303	R12-1545-05	RES. SEMI FIXED	1K B		

PANEL UNIT (X66-1100-00)

REF.NO	PARTS NO	NAME & DESCRIPTION			
	E31-5874-05	WIRE ASS'Y(JW1)			
	E31-5875-05	WIRE ASS'Y(JW2)			
	E31-5876-05	WIRE ASS'Y(JW3)			
	E31-5877-05	WIRE ASS'Y(JW4)			
C001	CK45FF1H103Z	CAP. CERAMIC	0.01		50V
D001	1SS132	DIODE			
Q001	2SC945(P)	TR. SI, NPN			
R001	RN148K2C3001F	RES. METAL FILM	3K	1%	1/6W
R002	RD148B2C473J	RES. CARBON	47K	5%	1/6W
S001	S31-1507-05	SLIDE SWITCH			
S002	S31-1508-05	SLIDE SWITCH			
S003	S40-1532-05	PUSH SWITCH			
S004	S31-2516-05	SLIDE SWITCH			
S005	S31-2518-05	SLIDE SWITCH			
S006	S40-1532-05	PUSH SWITCH			
VR001	R05-3524-05	V.R.			
VR002	R05-3523-05	V.R.			
VR003	R05-3522-05	V.R.			
VR004	R05-3522-05	V.R.			
VR005	R05-3522-05	V.R.			

PARTS LIST

POWER SUPPLY UNIT (X68-1570-00)

REF.NO	PARTS NO	NAME & DESCRIPTION
	E31-0564-05	WIRE ASS'Y(GND GREEN)
	E31-5889-05	WIRE ASS'Y(JWB)
	F01-0867-05	HEAT SINK
	J25-5390-22	PCB (UNMOUNTED)
	L19-0427-05	CONVERTOR TRANSFORMER
	R92-0150-05	JUMPING RES. ZERO OHM (10MM)
	R92-1061-05	JUMPING RES. ZERO OHM (5MM)
C001	CE04W2E101M	CAP. ELECTRO 100 20% 250V
C002	CE04EW1C472M	CAP. ELECTRO 4700 20% 16V
C003	CE04EW1C472M	CAP. ELECTRO 4700 20% 16V
C004	CE04W2C3R3M	CAP. ELECTRO 3.3 20% 160V
C005	CE04EW1A221M	CAP. ELECTRO 220 20% 10V
C006	CE04EW1A221M	CAP. ELECTRO 220 20% 10V
C007	CE04EW1A221M	CAP. ELECTRO 220 20% 10V
C008	CE04W2E010M	CAP. ELECTRO 1 20% 250V
C009	CE04HW1H010M	CAP. ELECTRO 1 20% 50V
C010	CE04EW1C101M	CAP. ELECTRO 100 20% 16V
C011	CK45B2H472K	CAP. CERAMIC 4700P 10% 500V
C012	CK45B2H472K	CAP. CERAMIC 4700P 10% 500V
C013	CK45B2H472K	CAP. CERAMIC 4700P 10% 500V
C014	CE04W2C010M	CAP. ELECTRO 1 20% 160V
C015	NO USE	
C016	CK45F81H222K	CAP. CERAMIC 2200P 10% 50V
C017	CE04EW1A470M	CAP. ELECTRO 47 20% 10V
C018	CE04EW1A470M	CAP. ELECTRO 47 20% 10V
C019	CK45FF1H103Z	CAP. CERAMIC 0.01 50V
C020	CE04EW1C101M	CAP. ELECTRO 100 20% 16V
C021	CE04EW1C101M	CAP. ELECTRO 100 20% 16V
C022	CK45B2H102K	CAP. CERAMIC 1000P 10% 500V
C023	C91-1317-05	CAP. CERAMIC 0.01 80/-20% 2K
C024	C91-1317-05	CAP. CERAMIC 0.01 80/-20% 2K
C025	CK45E3D102P	CAP. CERAMIC 1000P 2KV
C026	C91-1317-05	CAP. CERAMIC 0.01 80/-20% 2K
C027	C91-1317-05	CAP. CERAMIC 0.01 80/-20% 2K
C028	C91-1317-05	CAP. CERAMIC 0.01 80/-20% 2K
C029	CK45E3D102P	CAP. CERAMIC 1000P 2KV
C030	CK45F1H103Z	CAP. CERAMIC 0.01 50V
C031	CK45B2H472K	CAP. CERAMIC 4700P 10% 500V
C032	CK45B2H472K	CAP. CERAMIC 4700P 10% 500V
C033	CK45B2H472K	CAP. CERAMIC 4700P 10% 500V
C034	C91-1309-05	CAP. CERAMIC 0.01 10% 500V
D001	S1VB60	DIODE
D002	S1VB20	DIODE
D003	1SS132	DIODE
D004	MT210JC	DIODE, ZENER 9.95V
D005	MT210JC	DIODE, ZENER 9.95V
D006	1SS132	DIODE
D007	1SS132	DIODE
D008	1SS132	DIODE
D009	Y10GA	DIODE
D010	Y10GA	DIODE
D011	1SS83	DIODE
D012	1SS83	DIODE
D013	1SS83	DIODE
D014	1SS83	DIODE
D015	1SS83	DIODE
D016	1SS132	DIODE
L001	L40-1011-04	FERRI INDUCTOR 100UH
L002	L40-1011-04	FERRI INDUCTOR 100UH
L003	L40-1021-03	FERRI INDUCTOR 1MH
NL001	NE-38B	NEON LAMP
NL002	NE-38B	NEON LAMP
P009	E40-3241-05	PIN CONNECTOR 6P
P010	E40-3237-05	PIN CONNECTOR 2P
P011	NO USE	
P012	E40-5069-05	PIN CONNECTOR 12P
P013	E40-3242-05	PIN CONNECTOR 7P
P014	E40-3238-05	PIN CONNECTOR 3P
Q001	2SA1156(L)	TR. SI, PNP
Q002	2SC2909(S)	TR. SI, NPN
Q003	2SC1384(R)	TR. SI, NPN
Q004	2SA684(R)	TR. SI, PNP
Q005	2SC1384(R)	TR. SI, NPN
Q006	2SA1208(S)	TR. SI, PNP
Q007	2SC2910(S)	TR. SI, NPN
Q008	2SD1666(R)	TR. SI, NPN

REF.NO	PARTS NO	NAME & DESCRIPTION
Q009	2SA733(P)	TR. SI, PNP
Q010	2SA1091(O)	TR. SI, PNP
Q011	2SA1091(O)	TR. SI, PNP
Q012	2SA1091(O)	TR. SI, PNP
Q013	2SC1384(R)	TR. SI, NPN
Q014	2SA684(R)	TR. SI, PNP
Q015	2SA733(P)	TR. SI, PNP
R001	RD14KB3H102J	RES. SPECIAL 1K 5%
R002	RD14BB2C102J	RES. CARBON 1K 5% 1/6W
R003	RD14BB2C102J	RES. CARBON 1K 5% 1/6W
R004	RD14BB2C100J	RES. CARBON 10 5% 1/6W
R005	RD14KB3D240J	RES. SPECIAL 24 5% 2W
R006	RD14BB2C221J	RES. CARBON 220 5% 1/6W
R007	RD14BB2C221J	RES. CARBON 220 5% 1/6W
R008	RD14KB3D240J	RES. SPECIAL 24 5% 2W
R009	RD14BB2E204J	RES. CARBON 200K 5% 1/4W
R010	RN14BK2C3301F	RES. METAL FILM 3.3K 1% 1/6W
R011	RN14BK2C6201F	RES. METAL FILM 6.2K 1% 1/6W
R012	RD14BB2C223J	RES. CARBON 22K 5% 1/6W
R013	NO USE	
R014	RD14BB2C163J	RES. CARBON 16K 5% 1/6W
R015	RD14BB2C432J	RES. CARBON 4.3K 5% 1/6W
R016	RD14BB2C562J	RES. CARBON 5.6K 5% 1/6W
R017	RD14BB2C164J	RES. CARBON 160K 5% 1/6W
R018	RD14BB2C132J	RES. CARBON 1.3K 5% 1/6W
R019	RD14BB2C104J	RES. CARBON 100K 5% 1/6W
R020	RD14BB2C470J	RES. CARBON 47 5% 1/6W
R021	RD14BB2C103J	RES. CARBON 10K 5% 1/6W
R022	RD14BB2C103J	RES. CARBON 10K 5% 1/6W
R023	RD14BB2C473J	RES. CARBON 47K 5% 1/6W
R024	RD14BB2C334J	RES. CARBON 330K 5% 1/6W
R025	RD14BB2C391J	RES. CARBON 390 5% 1/6W
R026	RD14BB2C222J	RES. CARBON 2.2K 5% 1/6W
R027	RD14BB2C682J	RES. CARBON 6.8K 5% 1/6W
R028	RD14BB2C102J	RES. CARBON 1K 5% 1/6W
R029	RN14BK2C5602F	RES. METAL FILM 56K 1% 1/6W
R030	RD14BB2C563J	RES. CARBON 56K 5% 1/6W
R031	RN14BK2E2204F	RES. METAL FILM 2.2M 1% 1/4W
R032	RN14BK2E2004F	RES. METAL FILM 2M 1% 1/4W
R033	RN14BK2E2204F	RES. METAL FILM 2.2M 1% 1/4W
R034	RN14BK2E2004F	RES. METAL FILM 2M 1% 1/4W
R035	RN14BK2E2204F	RES. METAL FILM 2.2M 1% 1/4W
R036	RN14BK2E2004F	RES. METAL FILM 2M 1% 1/4W
R037	RD14BB2C224J	RES. CARBON 220K 5% 1/6W
R038	RD14BB2C134J	RES. CARBON 130K 5% 1/6W
R039	NO USE	
R040	RD14BB2C101J	RES. CARBON 100 5% 1/6W
R041	RD14BB2E395J	RES. CARBON 3.9M 5% 1/4W
R042	RD14BB2E395J	RES. CARBON 3.9M 5% 1/4W
R043	RD14BB2E395J	RES. CARBON 3.9M 5% 1/4W
R044	RD14BB2E225J	RES. CARBON 2.2M 5% 1/4W
R045	RD14BB2E225J	RES. CARBON 2.2M 5% 1/4W
R046	RD14BB2E225J	RES. CARBON 2.2M 5% 1/4W
R047	RD14BB2E225J	RES. CARBON 2.2M 5% 1/4W
R048	RD14BB2E225J	RES. CARBON 2.2M 5% 1/4W
R049	RD14BB2E395J	RES. CARBON 3.9M 5% 1/4W
R050	RD14BB2C823J	RES. CARBON 82K 5% 1/6W
R051	RD14BB2C563J	RES. CARBON 56K 5% 1/6W
R052	RD14BB2C7R5J	RES. CARBON 7.5 5% 1/6W
R053	RD14BB2C220J	RES. CARBON 22 5% 1/6W
R054	RD14BB2C470J	RES. CARBON 47 5% 1/6W
R055	RD14BB2C473J	RES. CARBON 47K 5% 1/6W
R056	RD14BB2C473J	RES. CARBON 47K 5% 1/6W
R057	RD14BB2C473J	RES. CARBON 47K 5% 1/6W
R058	RD14BB2E515J	RES. CARBON 5.1M 5% 1/4W
R059	NO USE	
R060	RD14BB2C474J	RES. CARBON 470K 5% 1/6W
R061	RD14BB2C104J	RES. CARBON 100K 5% 1/6W
R062	RD14BB2C104J	RES. CARBON 100K 5% 1/6W
R063	RD14BB2C752J	RES. CARBON 7.5K 5% 1/6W

U001	KMA01	IC, LINEAR
U002	NJM4558D	IC, DUAL OP AMP
VR001	R12-1543-05	RES. SEMI FIXED 1KB
VR002	R12-5528-05	RES. SEMI FIXED 10K B
VR003	R12-8501-05	RES. SEMI FIXED 2.2M B

PARTS LIST

CRT SOCKET UNIT (X81-2810-00)

REF.NO	PARTS NO	NAME & DESCRIPTION
	E01-0103-05	CRT SOCKET
	E31-5885-05	WIRE ASS'Y(JW6)
	E31-5886-05	WIRE ASS'Y(JW7)
	E31-5887-05	WIRE ASS'Y(JW9)
	E31-5888-05	WIRE ASS'Y(JW12)
	J13-0041-05	FUSE HOLDER
C101	CC45CH2H010C	CAP. CERAMIC 1P 0.25P 500V
D001	1SS132	DIODE
D002	NO USE	
D003	1SS132	DIODE
L101	L40-1591-70	FERRI INDUCTOR 1.5UH
L102	L40-1591-70	FERRI INDUCTOR 1.5UH
P014	E40-3237-05	PIN CONNECTOR 2P
P015	E40-0218-05	PIN CONNECTOR 2P
P016	E40-7103-05	PIN CONNECTOR 3P
P017	E40-0305-05	PIN CONNECTOR 2P
P018	E40-7106-05	PIN CONNECTOR 6P
Q001	2SC945(P)	TR. SI, NPN
R001	RD14BB2C104J	RES. CARBON 100K 5% 1/6W
R002	NO USE	
R003	RN14BK2C1803F	RES. METAL FILM 180K 1% 1/6W
R004	RN14BK2C1301F	RES. METAL FILM 1.3K 1% 1/6W
R005	RD14BB2C561J	RES. CARBON 560 5% 1/6W
R101	RD14BB2C471J	RES. CARBON 470 5% 1/6W
R102	RD14BB2C471J	RES. CARBON 470 5% 1/6W
VR001	R12-5540-05	RES. SEMI FIXED 100K B
VR002	R12-3563-05	RES. SEMI FIXED 10K B
VR003	R05-3522-05	V.R.
VR004	R05-3522-05	V.R.

CRT SOCKET UNIT (X81-2810-01)

REF.NO	PARTS NO	NAME & DESCRIPTION
	E01-0103-05	CRT SOCKET
	E31-5885-05	WIRE ASS'Y(JW6)
	E31-5886-05	WIRE ASS'Y(JW7)
	E31-5887-05	WIRE ASS'Y(JW9)
	E31-5888-05	WIRE ASS'Y(JW12)
	J13-0039-05	FUSE HOLDER
C101	CC45CH2H010C	CAP. CERAMIC 1P 0.25P 500V
D001	1SS132	DIODE
D002	NO USE	
D003	1SS132	DIODE
L101	L40-1591-70	FERRI INDUCTOR 1.5UH
L102	L40-1591-70	FERRI INDUCTOR 1.5UH
P014	E40-3237-05	PIN CONNECTOR 2P
P015	E40-0218-05	PIN CONNECTOR 2P
P016	E40-7103-05	PIN CONNECTOR 3P
P017	E40-0305-05	PIN CONNECTOR 2P
P018	E40-7106-05	PIN CONNECTOR 6P
Q001	2SC945(P)	TR. SI, NPN
R001	RD14BB2C104J	RES. CARBON 100K 5% 1/6W
R002	NO USE	
R003	RN14BK2C1803F	RES. METAL FILM 180K 1% 1/6W
R004	RN14BK2C1301F	RES. METAL FILM 1.3K 1% 1/6W
R005	RD14BB2C561J	RES. CARBON 560 5% 1/6W
R101	RD14BB2C471J	RES. CARBON 470 5% 1/6W
R102	RD14BB2C471J	RES. CARBON 470 5% 1/6W
VR001	R12-5540-05	RES. SEMI FIXED 100K B
VR002	R12-3563-05	RES. SEMI FIXED 10K B
VR003	R05-3522-05	V.R.
VR004	R05-3522-05	V.R.

CRT SOCKET UNIT (X81-2810-02)

REF.NO	PARTS NO	NAME & DESCRIPTION
	E01-0103-05	CRT SOCKET
	E31-5885-05	WIRE ASS'Y(JW6)
	E31-5886-05	WIRE ASS'Y(JW7)
	E31-5887-05	WIRE ASS'Y(JW9)
	E31-5888-05	WIRE ASS'Y(JW12)
C101	CC45CH2H010C	CAP. CERAMIC 1P 0.25P 500V
D001	1SS132	DIODE
D002	NO USE	
D003	1SS132	DIODE
L101	L40-1591-70	FERRI INDUCTOR 1.5UH
L102	L40-1591-70	FERRI INDUCTOR 1.5UH
P014	E40-3237-05	PIN CONNECTOR 2P
P015	E40-0218-05	PIN CONNECTOR 2P
Q001	2SC945(P)	TR. SI, NPN
R001	RD14BB2C104J	RES. CARBON 100K 5% 1/6W
R002	NO USE	
R003	RN14BK2C1803F	RES. METAL FILM 180K 1% 1/6W
R004	RN14BK2C1301F	RES. METAL FILM 1.3K 1% 1/6W
R005	RD14BB2C561J	RES. CARBON 560 5% 1/6W
R101	RD14BB2C471J	RES. CARBON 470 5% 1/6W
R102	RD14BB2C471J	RES. CARBON 470 5% 1/6W
VR001	R12-5540-05	RES. SEMI FIXED 100K B
VR002	R12-3563-05	RES. SEMI FIXED 10K B
VR003	R05-3522-05	V.R.
VR004	R05-3522-05	V.R.

SCHEMATIC DIAGRAM

X66-1100-00 A/2 (PANEL UNIT)

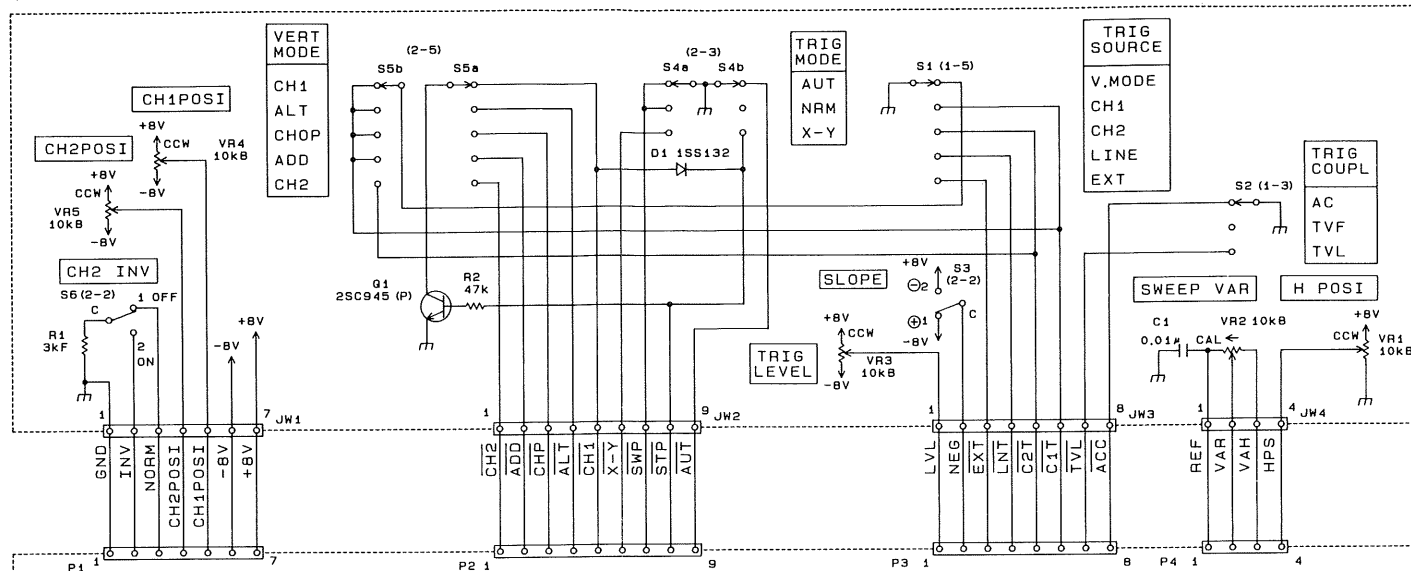

X65-1380-00 B/2 (V.H UNIT)

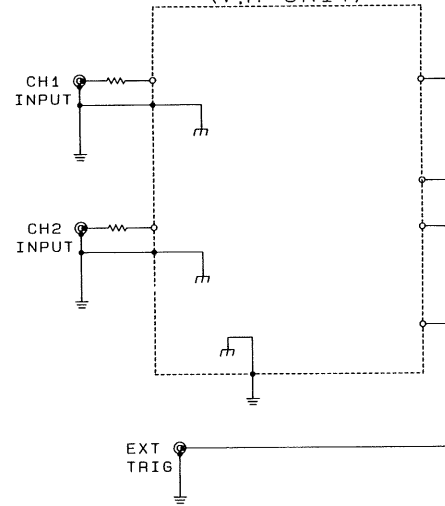

X65-1380-00 A/2 (V.H UNIT)

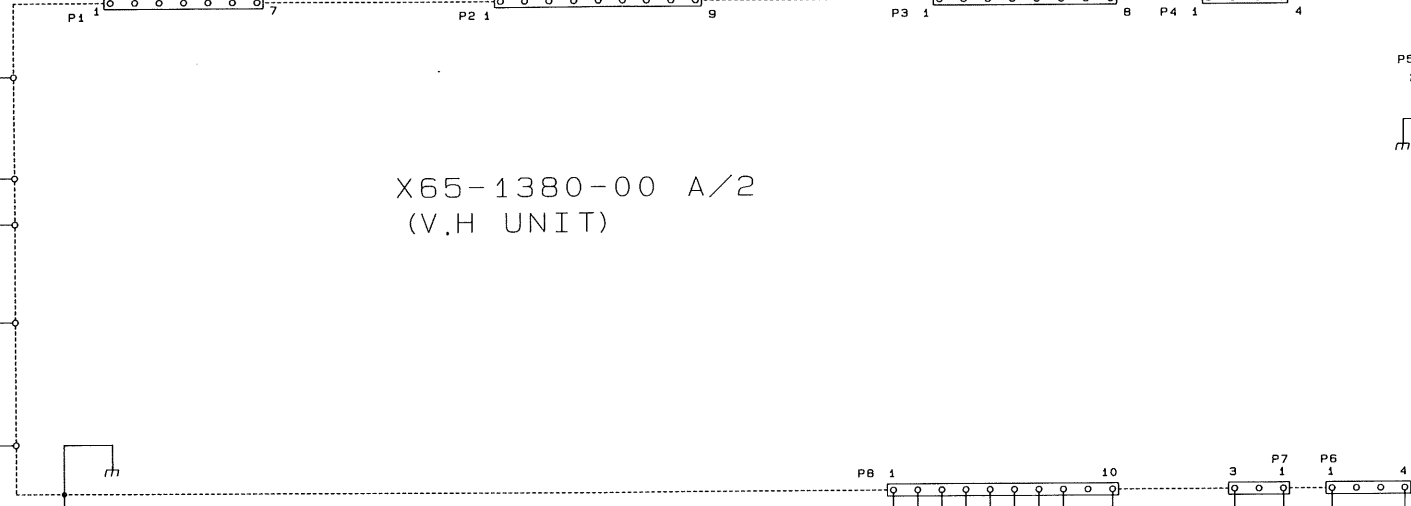

CRT1
1506TM31A

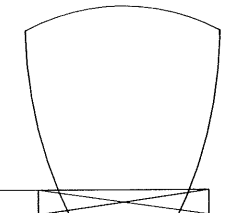

X81-2810-00 C/3 (CRT SOCKET UNIT)

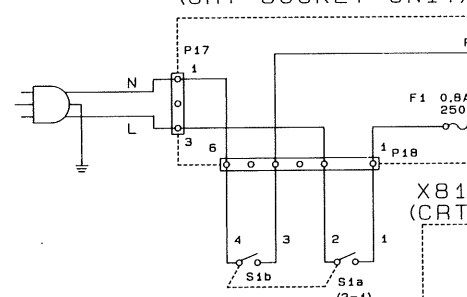

X68-1570-00 (POWER SUPPLY UNIT)

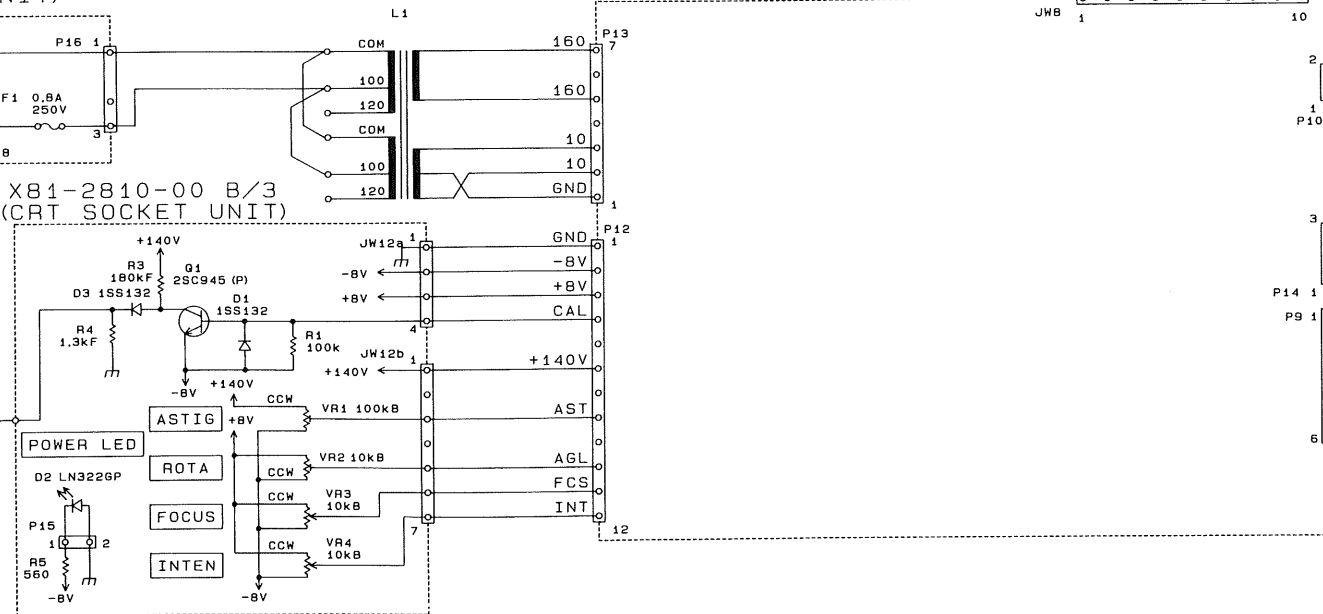

X81-2810-00 B/3 (CRT SOCKET UNIT)

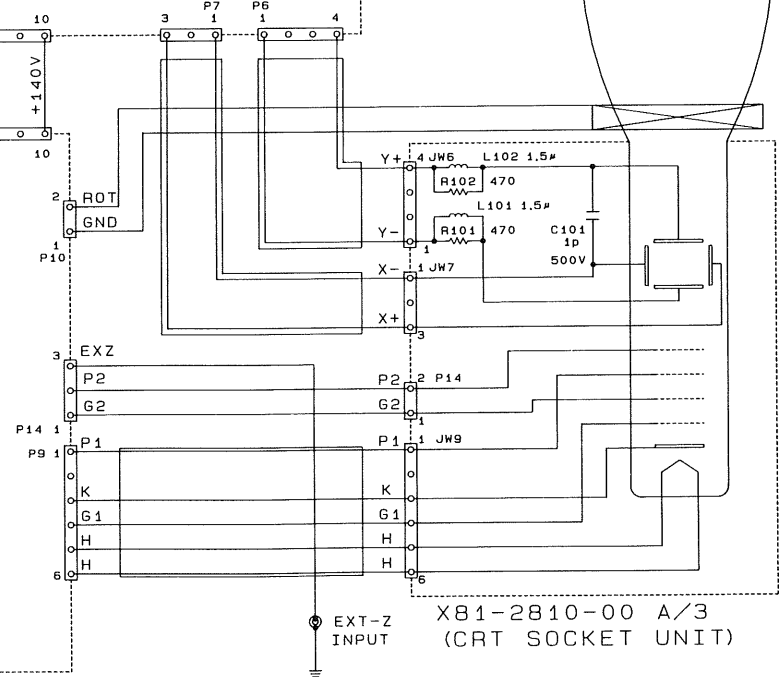
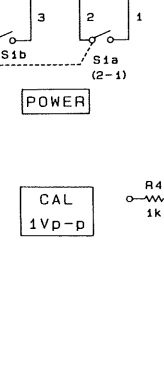

X81-2810-00 A/3 (CRT SOCKET UNIT)

SCHEMATIC DIAGRAM (Only for the types with a voltage selector)

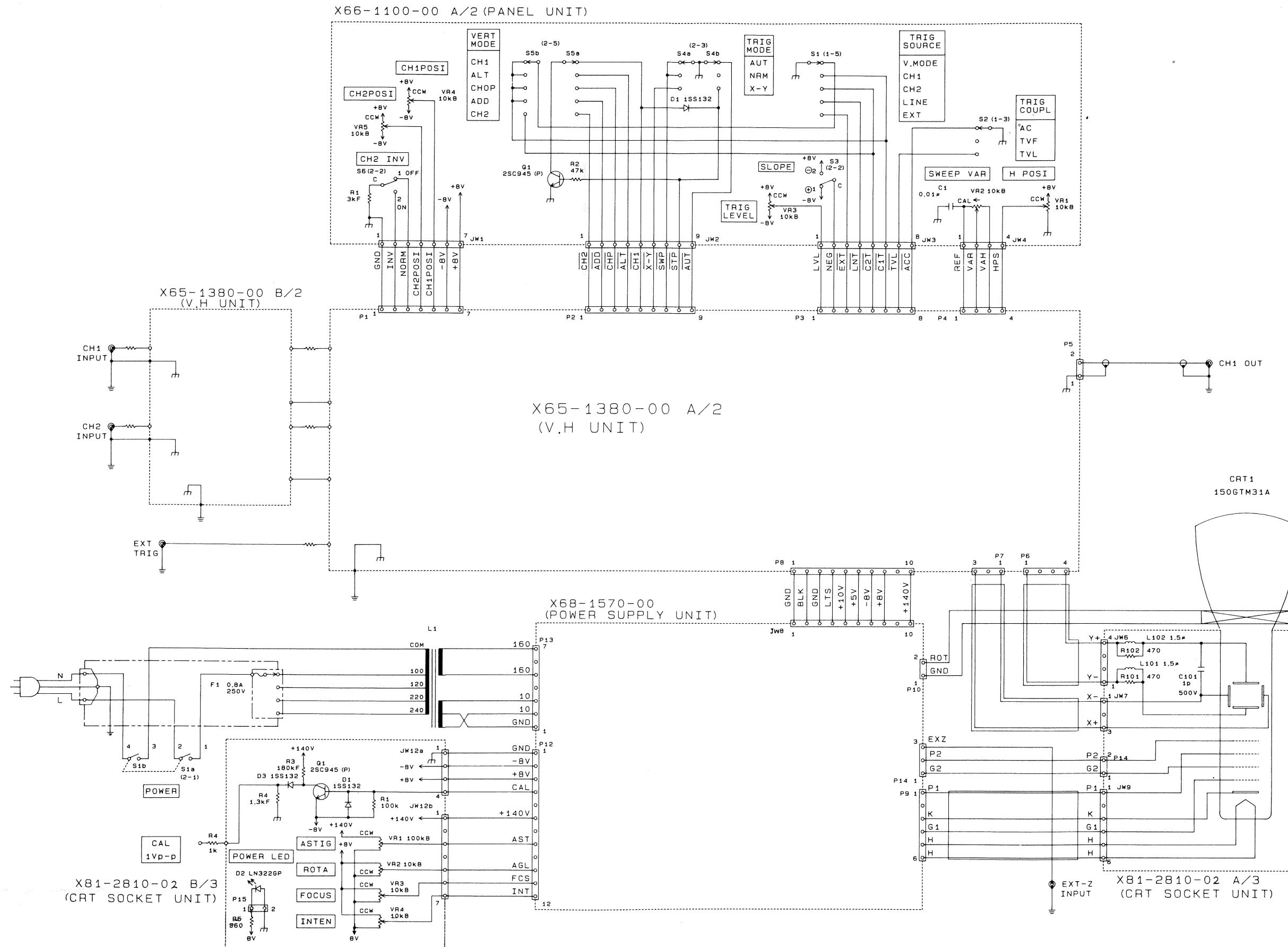

SCHEMATIC DIAGRAM/WAVEFORM POWER SUPPLY UNIT (X68-1570-00)

X68-1570-00 (POWER SUPPLY UNIT)

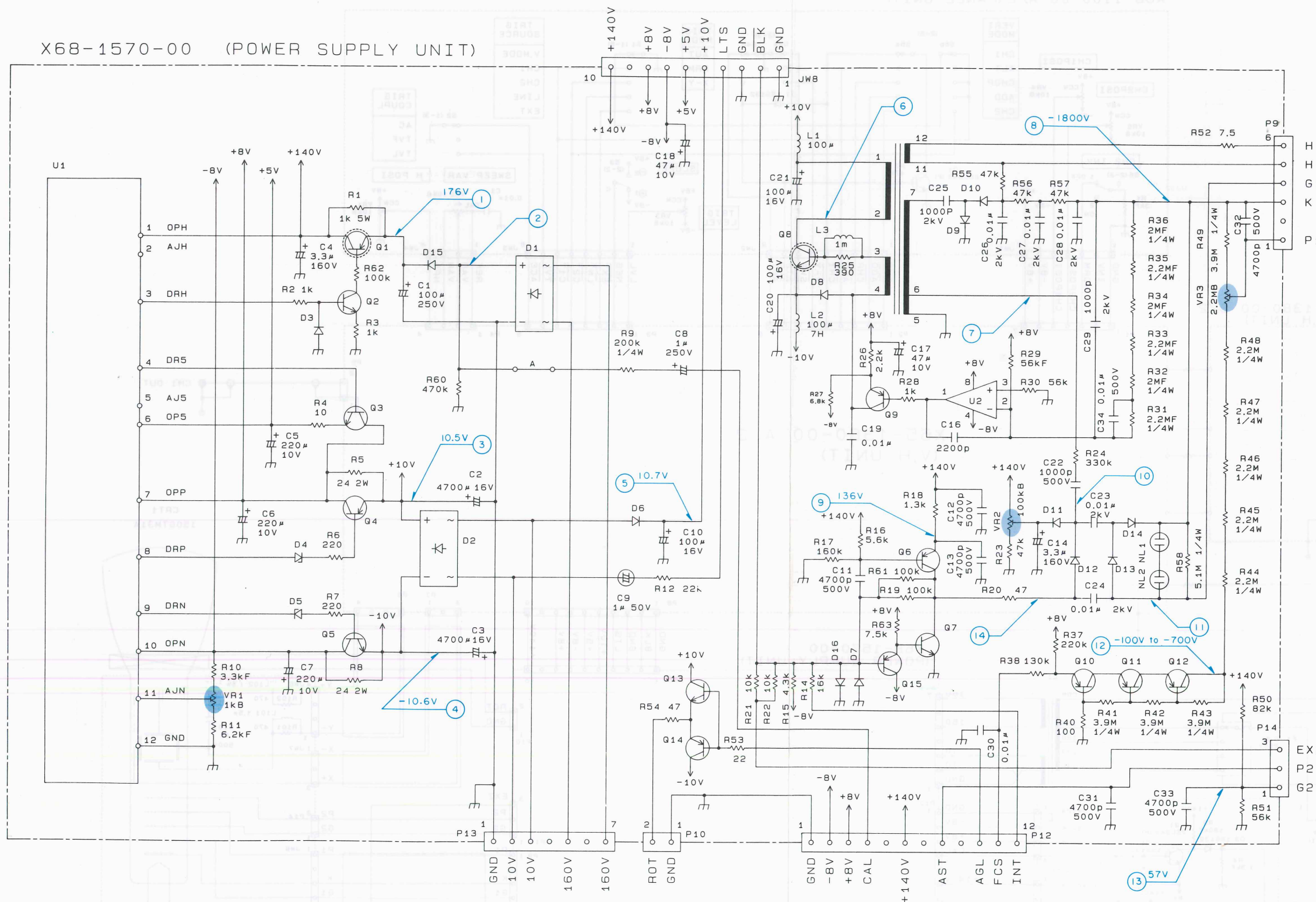

- | | | | |
|-----|-------------|-----|-------------|
| U1 | KMA01 | NL1 | NE388 |
| U2 | NJM4558D | NL2 | NE388 |
| Q1 | 2SA1156 (L) | Q9 | 2SA733 (P) |
| Q2 | 2SC2909 (S) | Q10 | 2SA1091 (O) |
| Q3 | 2SC1384 (R) | Q11 | 2SA1091 (O) |
| Q4 | 2SA684 (R) | Q12 | 2SA1091 (O) |
| Q5 | 2SC1384 (R) | Q13 | 2SC1384 (R) |
| Q6 | 2SA1208 (S) | Q14 | 2SA684 (R) |
| Q7 | 2SC2910 (S) | Q15 | 2SA733 (P) |
| Q8 | 2SD1666 (R) | | |
| D1 | S1VB60 | D11 | 1SS83 |
| D2 | S1VB20 | D12 | 1SS83 |
| D3 | 1SS132 | D13 | 1SS83 |
| D4 | MTZ10JC | D14 | 1SS83 |
| D5 | MTZ10JC | D15 | 1SS83 |
| D6 | 1SS132 | D16 | 1SS132 |
| D7 | 1SS132 | | |
| D8 | 1SS132 | | |
| D9 | Y10GA | | |
| D10 | Y10GA | | |

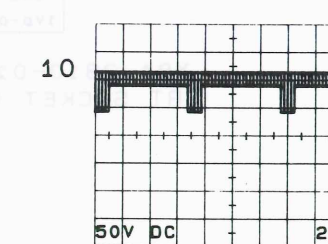
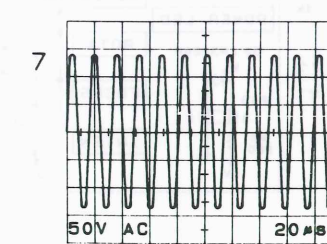
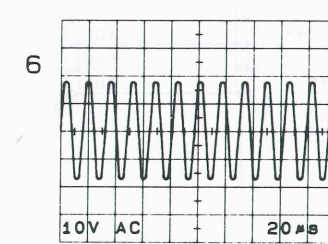
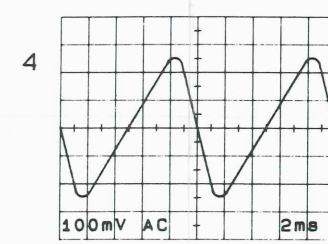
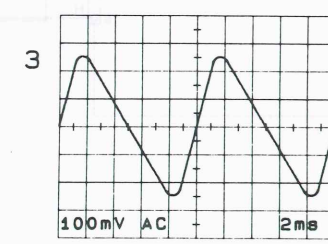
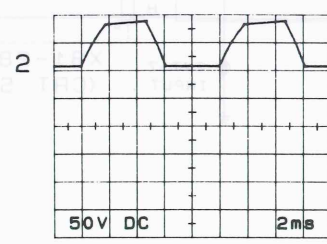
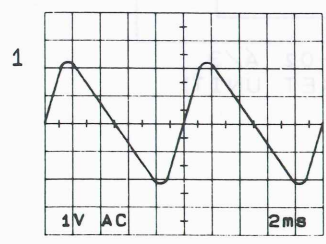
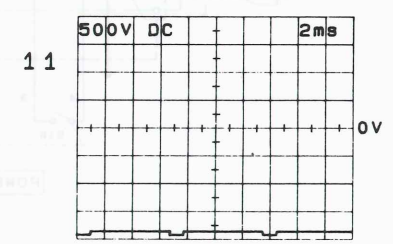
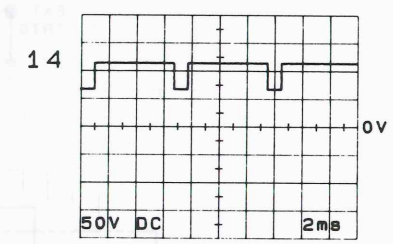

SCHEMATIC DIAGRAM/WAVEFORM VERTICAL & HORIZONTAL UNIT (X65-1380-00)(1/2)

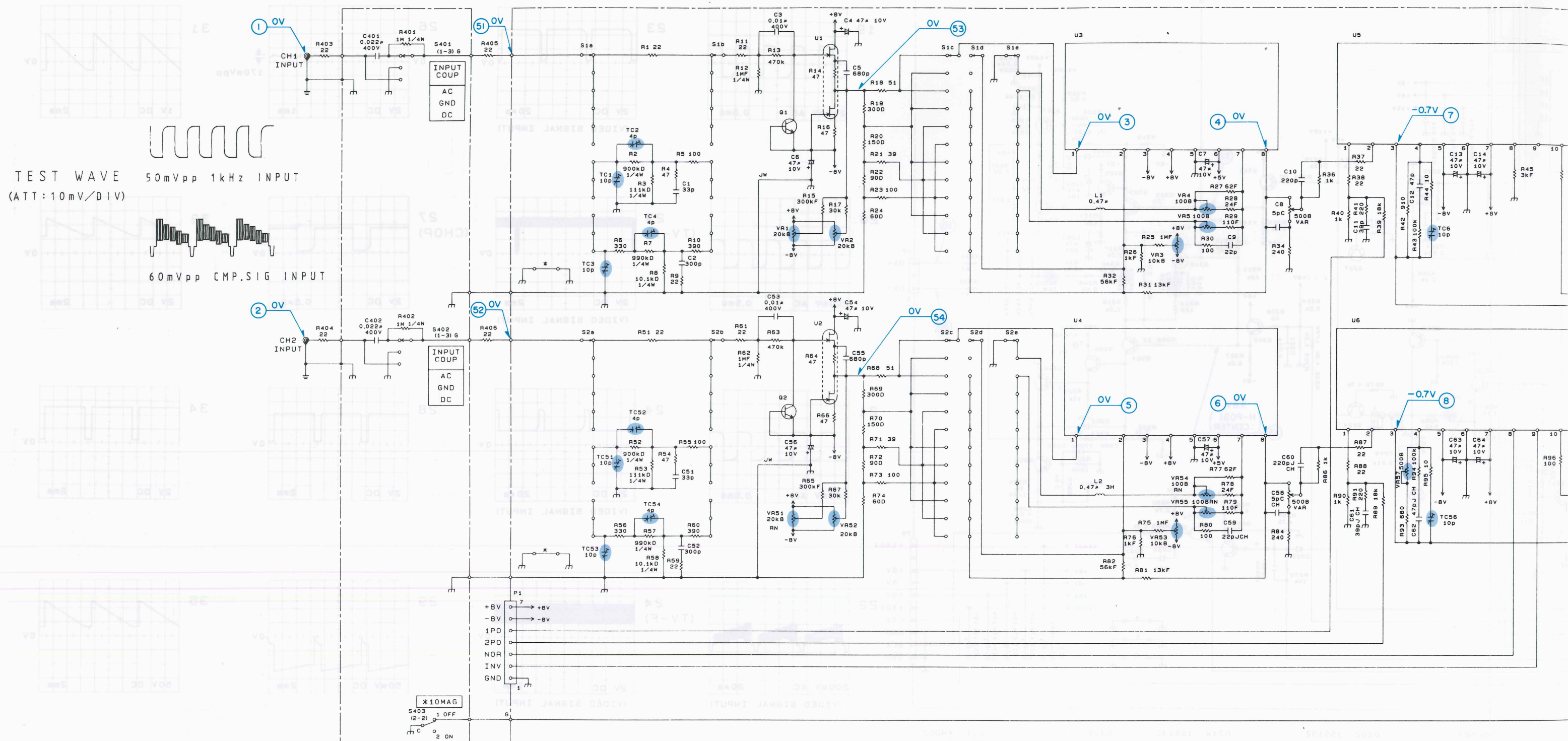

TEST WAVE 50mVpp 1kHz INPUT
(ATT: 10mV/DIV)

60mVpp CMP.SIG INPUT

- | | | | | | |
|-----|-------------|-----|-------------|----|------------|
| Q1 | 2SC1923 (O) | Q13 | 2SA1477 (S) | U1 | #PA68H (L) |
| Q2 | 2SC1923 (O) | Q14 | 2SC3787 (S) | U2 | #PA68H (L) |
| Q3 | 2SC945 (P) | Q15 | 2SA1477 (S) | U3 | KMCO1 |
| Q4 | 2SA733 (P) | Q16 | 2SA733 (P) | U4 | KMCO1 |
| Q5 | 2SA733 (P) | Q17 | 2SC945 (P) | U5 | KMCO2 |
| Q6 | 2SC1923 (O) | Q18 | 2SC945 (P) | U6 | KMCO2 |
| Q7 | 2SC1923 (O) | Q19 | 2SA733 (P) | | |
| Q8 | 2SC1923 (O) | Q20 | 2SC945 (P) | | |
| Q9 | 2SC1923 (O) | Q21 | 2SC945 (P) | | |
| Q10 | 2SA1005 (K) | Q22 | 2SC945 (P) | | |
| Q11 | 2SA1005 (K) | Q23 | 2SC945 (P) | | |
| Q12 | 2SC3787 (S) | | | | |

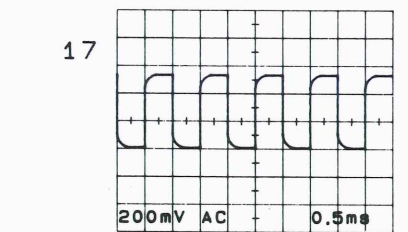
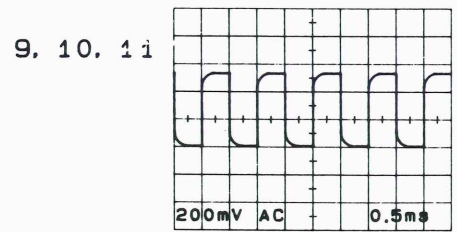
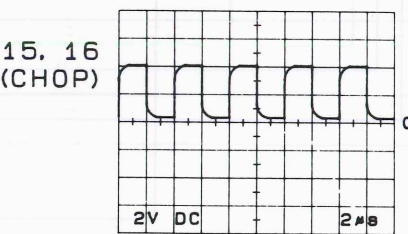
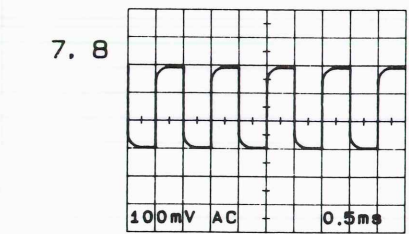
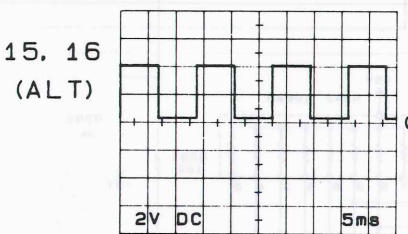
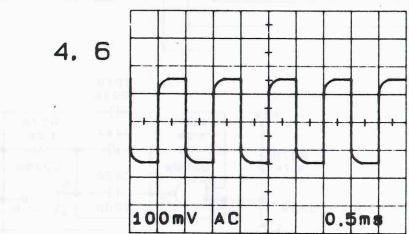
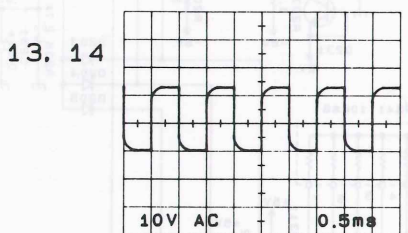
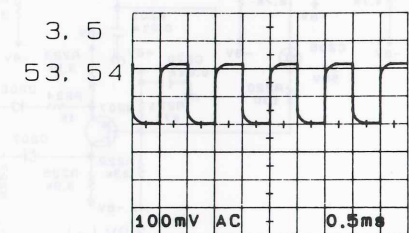
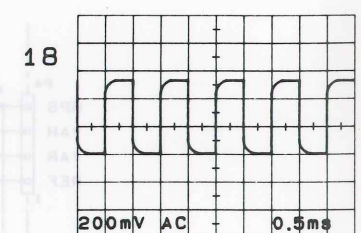
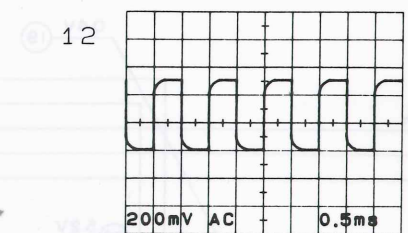
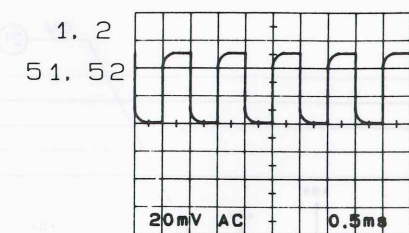
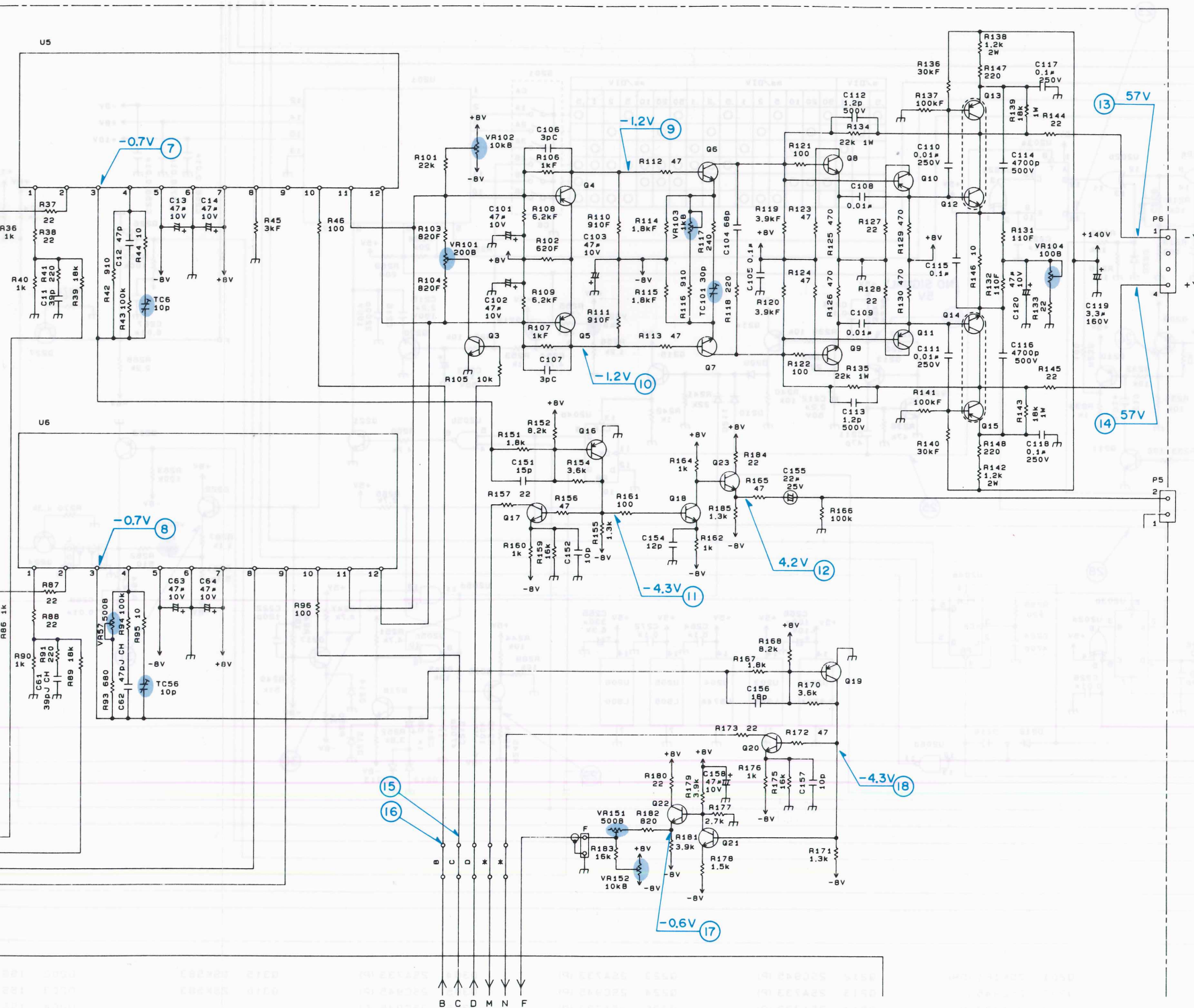

SCHEMATIC DIAGRAM/WAVEFORM VERTICAL & HORIZONTAL UNIT (X65-1380-00)(2/2)

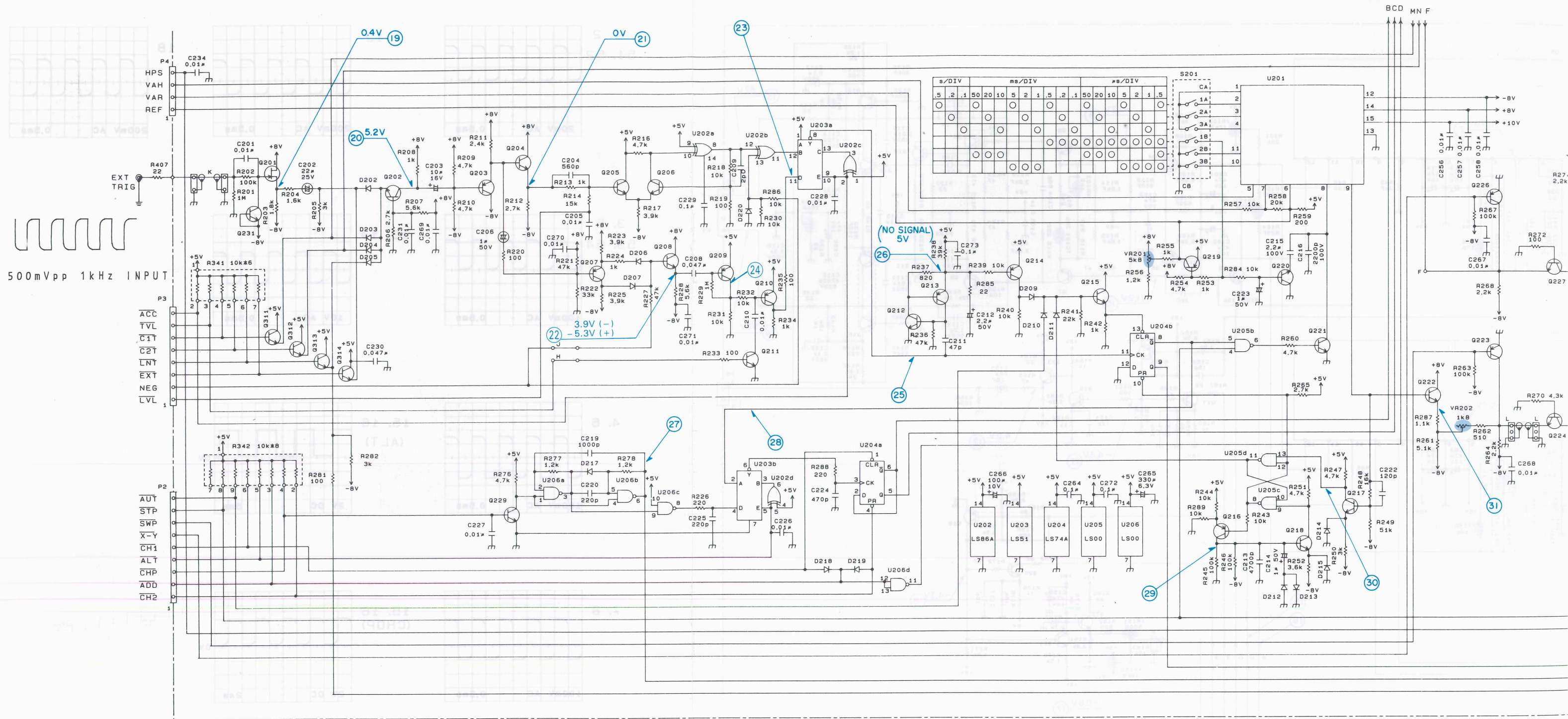

Q201	2SK161 (GR)	Q212	2SC945 (P)	Q223	2SA733 (P)	Q304	2SA733 (P)	Q315	2SK583	D202
Q202	2SC945 (P)	Q213	2SA733 (P)	Q224	2SC945 (P)	Q305	2SC945 (P)	Q316	2SK583	D203
Q203	2SA733 (P)	Q214	2SA733 (P)	Q226	2SA733 (P)	Q306	2SC945 (P)			D204
Q204	2SC945 (P)	Q215	2SC945 (P)	Q227	2SC945 (P)	Q307	2SA1209 (S. T)			D205
Q205	2SC1923 (O)	Q216	2SA733 (P)			Q308	2SC2911 (S. T)			D206
Q206	2SC1923 (O)	Q217	2SC945 (P)	Q229	2SC945 (P)	Q309	2SC2911 (S. T)			D207
Q207	2SA733 (P)	Q218	2SC945 (P)	Q230	2SC945 (P)	Q310	2SA1209 (S. T)			D209
Q208	2SC945 (P)	Q219	2SA733 (P)	Q231	2SC945 (P)	Q311	2SC945 (P)			D210
Q209	2SA733 (P)	Q220	2SC945 (P)	Q232	2SC945 (P)	Q312	2SC945 (P)			D211
Q210	2SA733 (P)	Q221	2SC3732 (L)	Q302	2SC945 (P)	Q313	2SC945 (P)			D212
Q211	2SC945 (P)	Q222	2SC945 (P)	Q303	2SA733 (P)	Q314	2SC945 (P)			D213

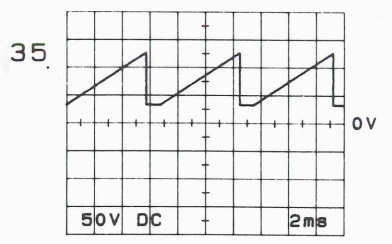
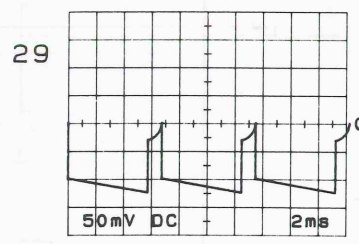
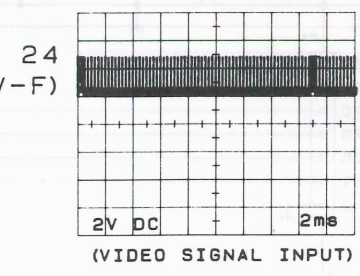
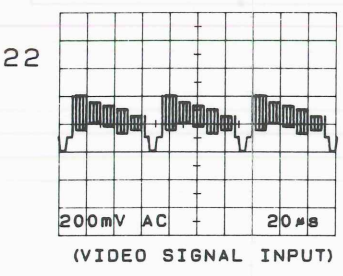
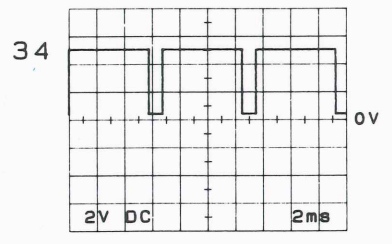
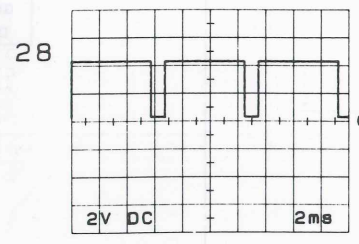
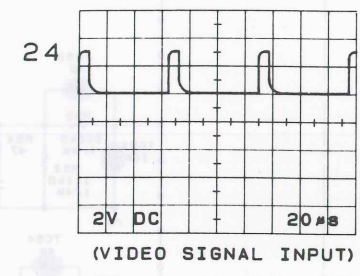
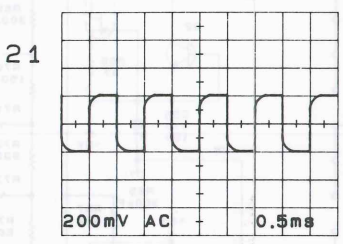
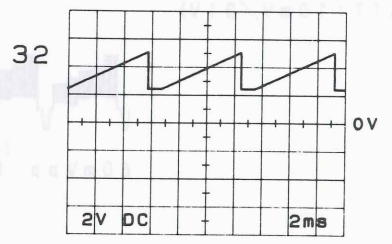
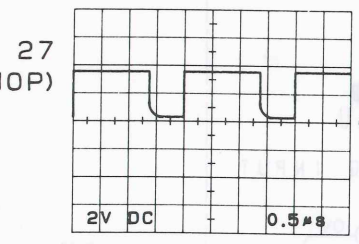
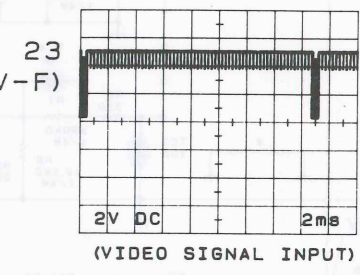
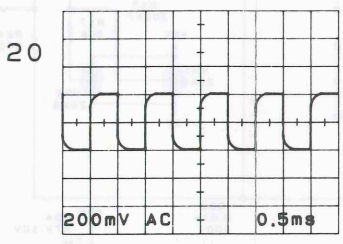
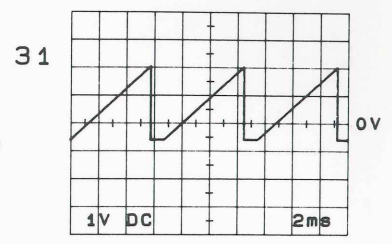
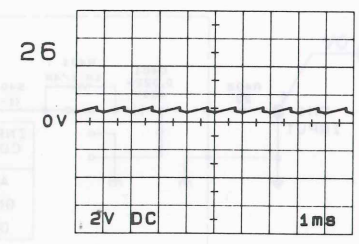
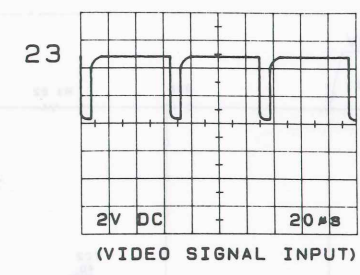
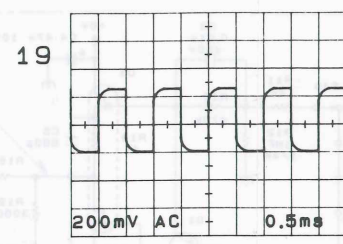
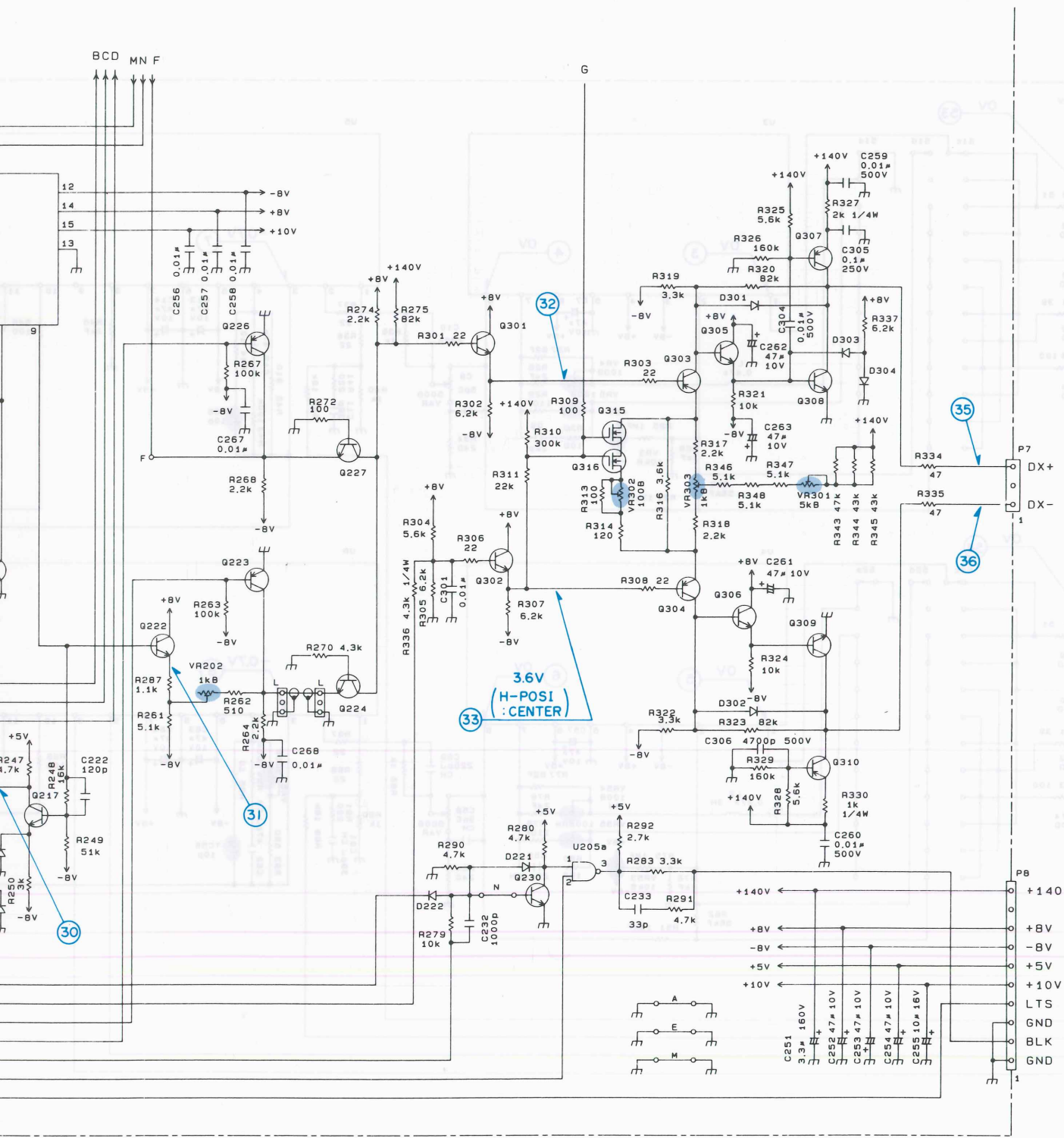

Q315	2SK583	D202	1SS132	D214	1SS132	D301	1SS83	U201	KMD02
Q316	2SK583	D203	1SS132	D215	1SS132	D302	1SS83	U202	SN74LS86AN
		D204	1SS132			D303	MA700	U203	SN74LS51N
		D205	1SS132	D217	1SS132	D304	1SS132	U204	SN74LS74AN
		D206	1SS132	D218	1SS132			U205	SN74LS00N
		D207	1SS132	D219	1SS132			U206	SN74LS00N
		D209	1SS132	D220	1SS132				
		D210	1SS132	D221	MA700				
		D211	1SS132	D222	1SS132				
		D212	1SS132						
		D213	1SS132						

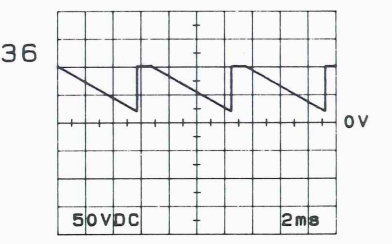
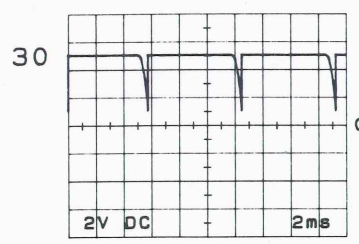
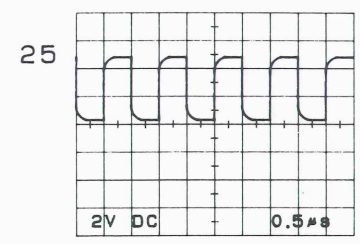

P.C. BOARD

VERTICAL & HORIZONTAL UNIT (X65-1380-00)

Pattern side view

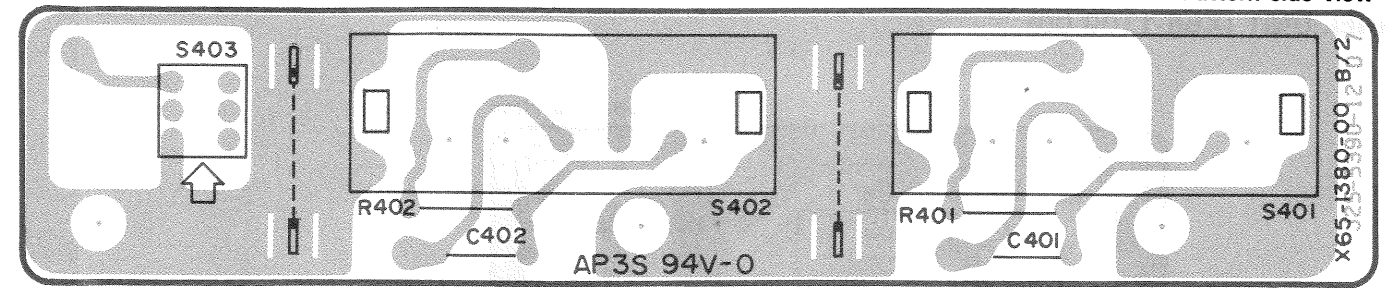

Parts side view

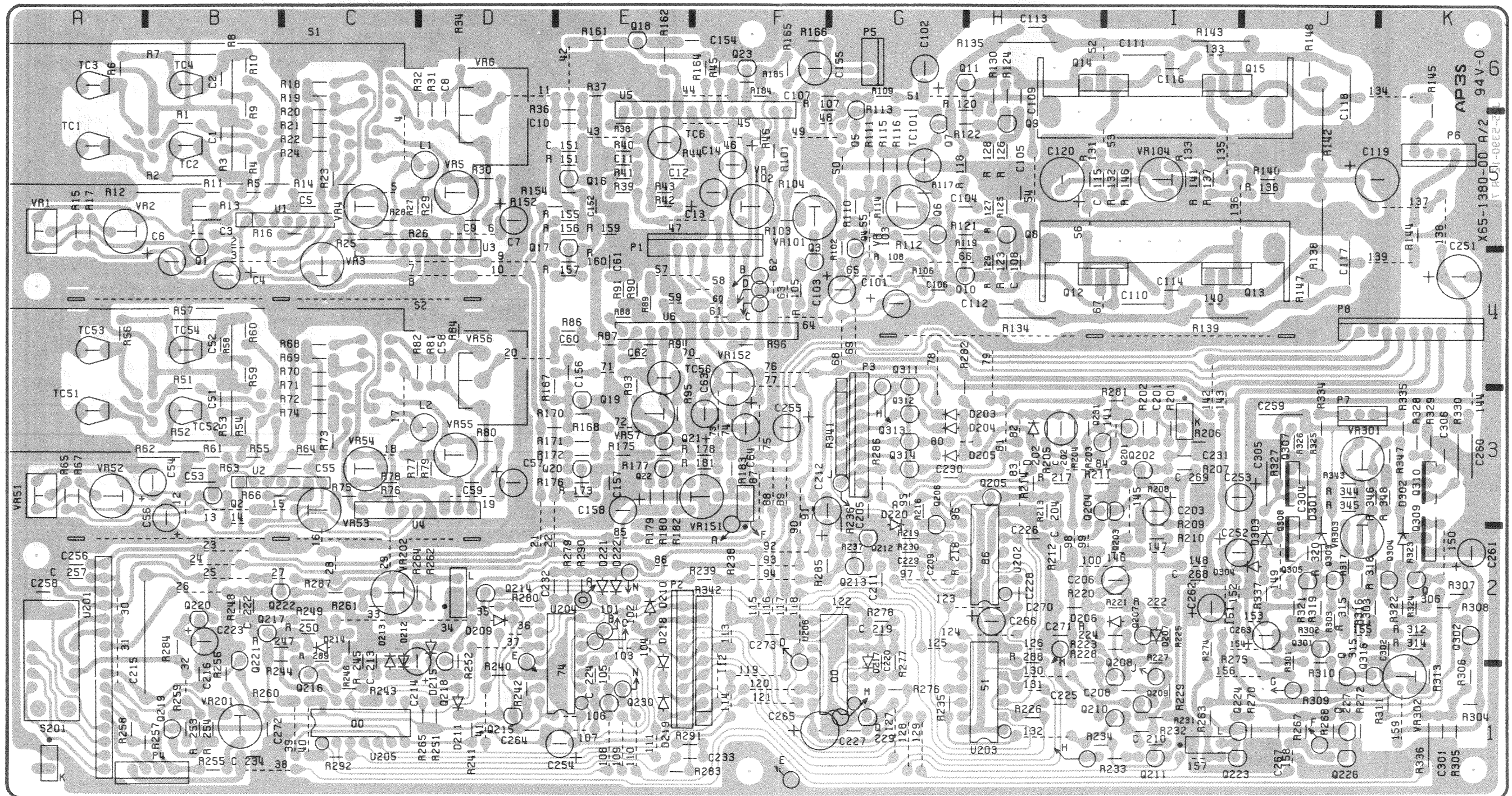

P.C. BOARD

PANEL UNIT (X66-1100-00)

POWER SUPPLY UNIT (X68-1570-00)

Pattern side view

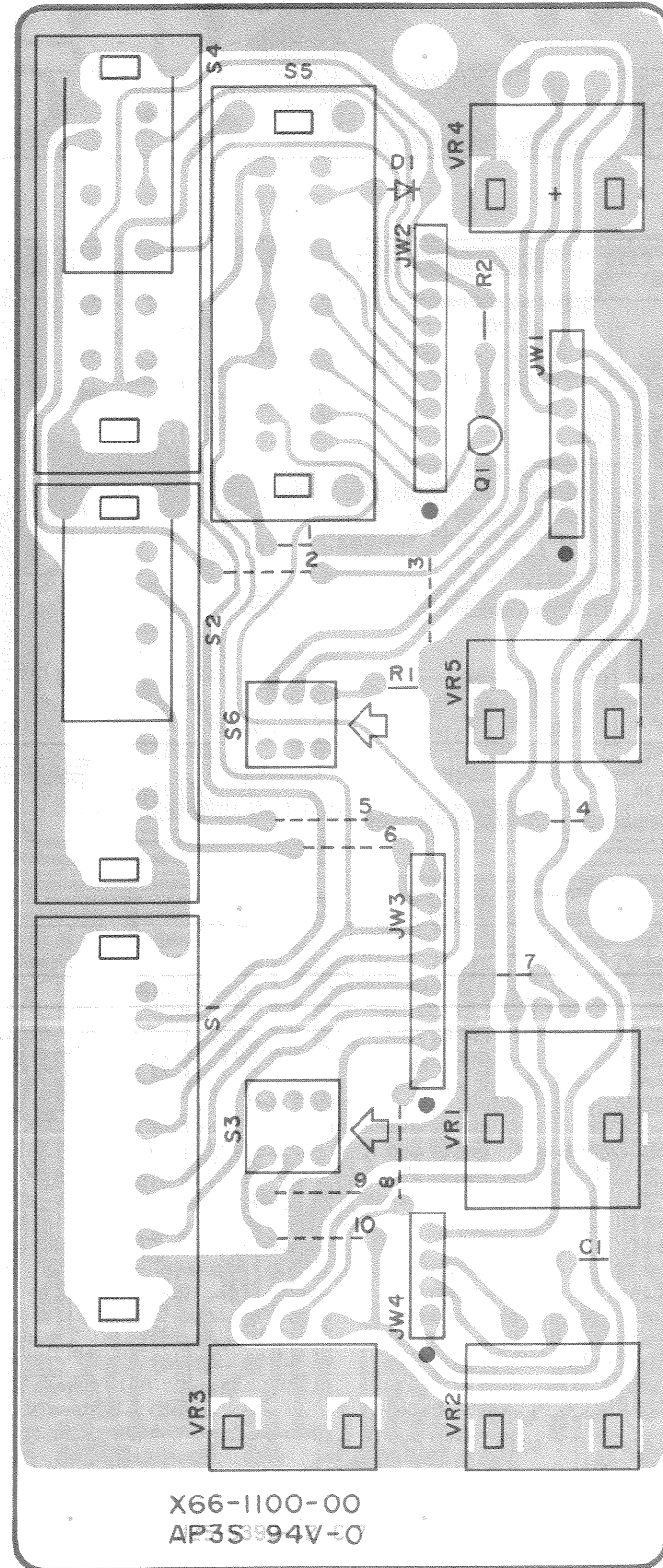

Parts side view

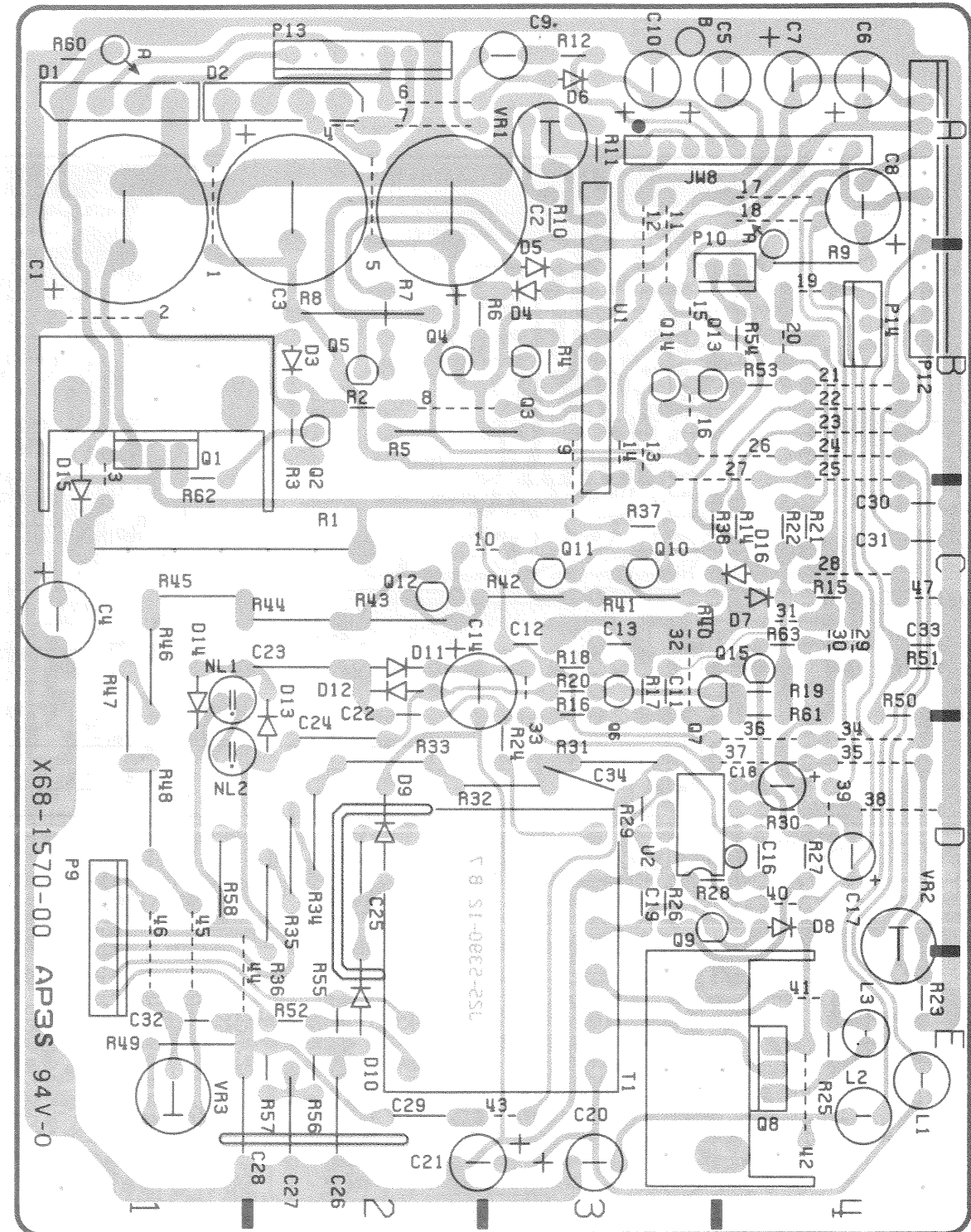

P.C. BOARD

CRT SOCKET UNIT (X81-2810-00)

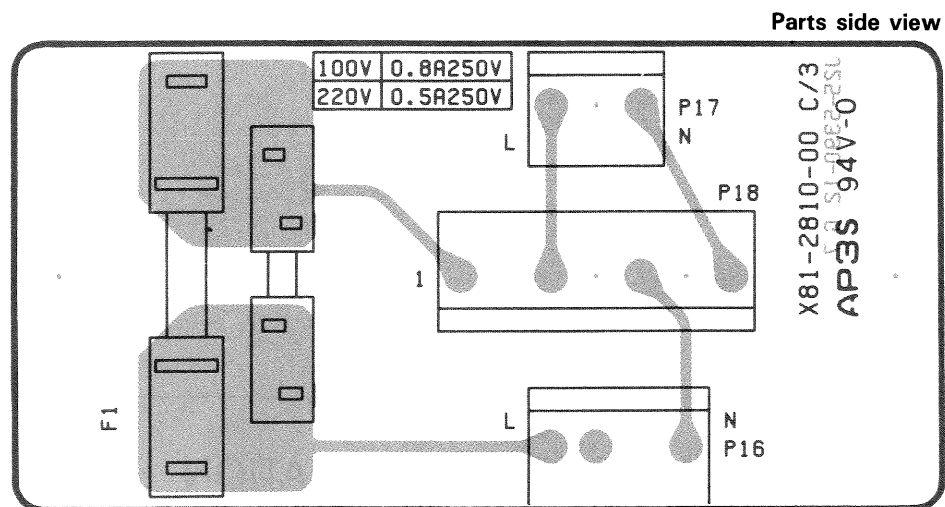
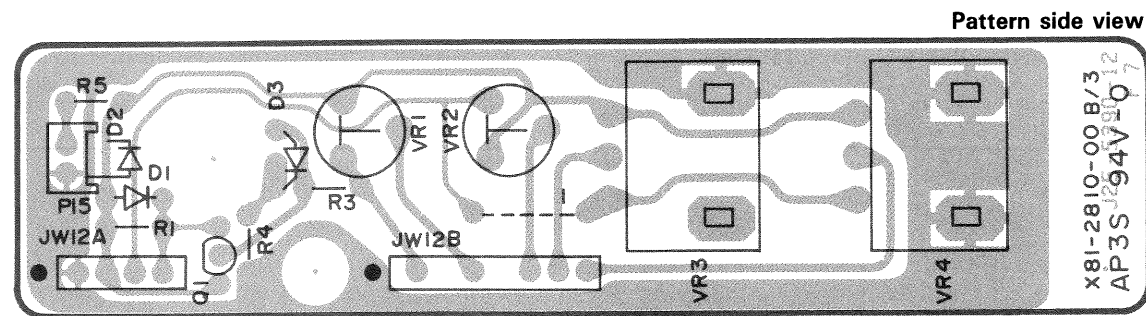
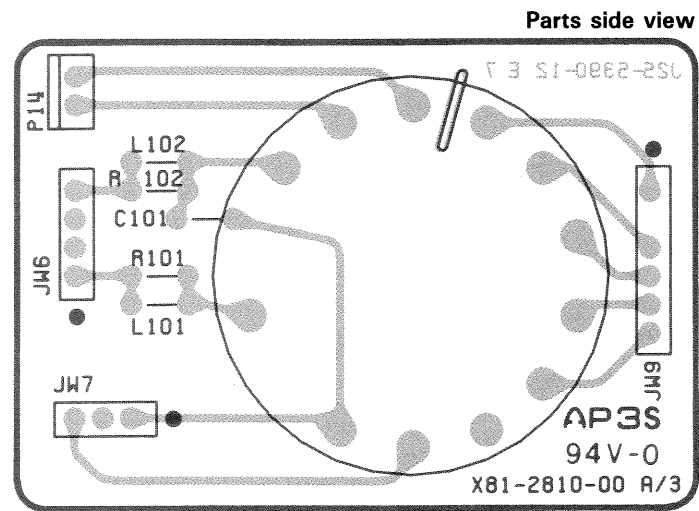

Note: Not used for the types with a voltage selector.

SEMICONDUCTORS

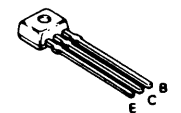
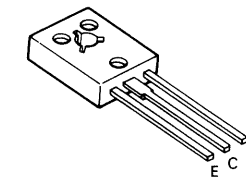
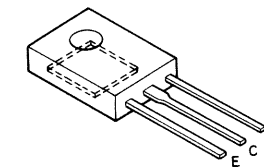
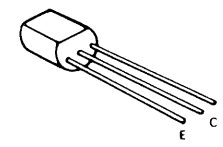
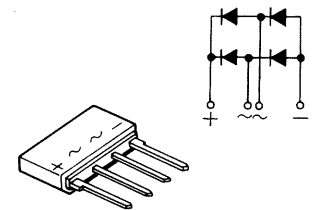
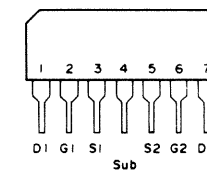
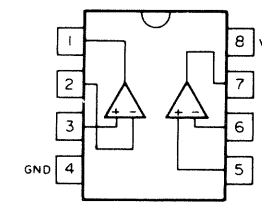
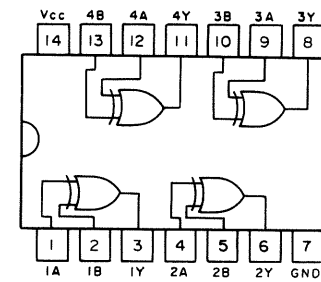
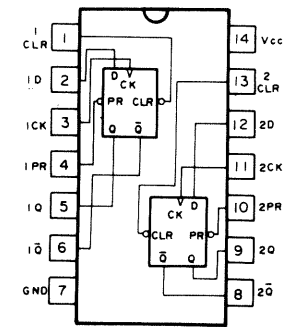
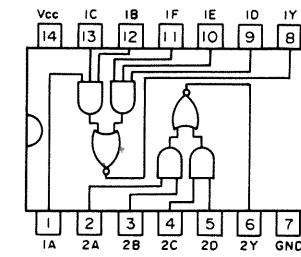
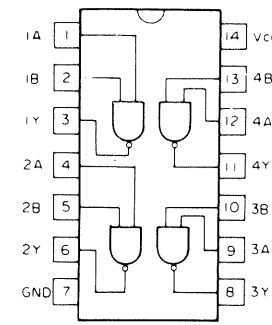

2SA684(R)
2SA733(P)
2SA1005(K)
2SA1091(O)
2SA1208(C)

2SC945(P)
1384(R)
1923(O)
2909(S)
2910(S)

2SA1156(L)

2SA1209(S,T)
2SC2911(S,T)

2SC3732(L)

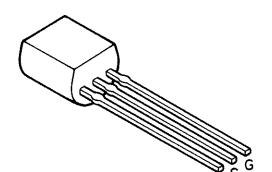
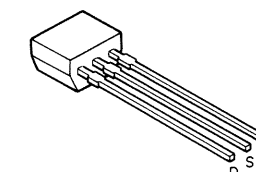
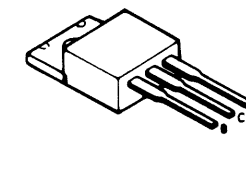
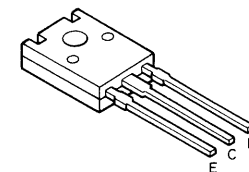

2SC3787(S,T)

2SD1666(R)

2SK161(GR)

2SK583

Q88

1984.10.10

A product of
KENWOOD CORPORATION
17-5, 2-chome, Shibuya, Shibuya-ku, Tokyo 150, Japan

B51-1087-00 (T)