

# P.C. BOARD

RT-1721 X77-1180-00

A

B

C

D

E

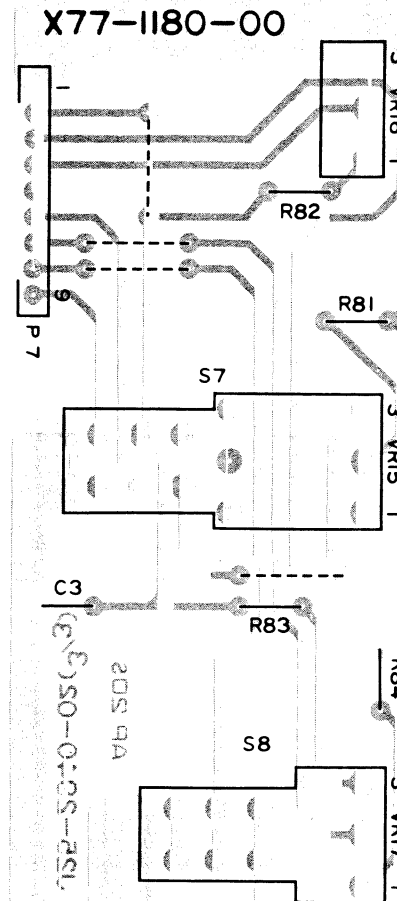
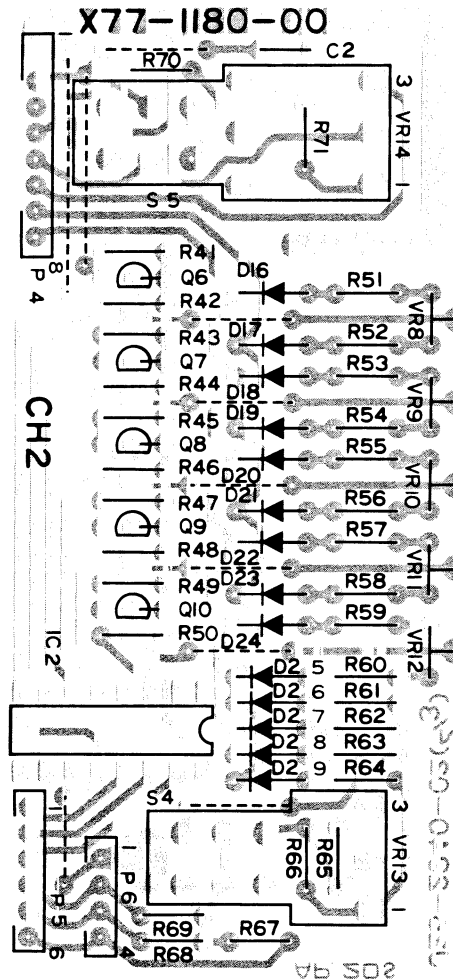
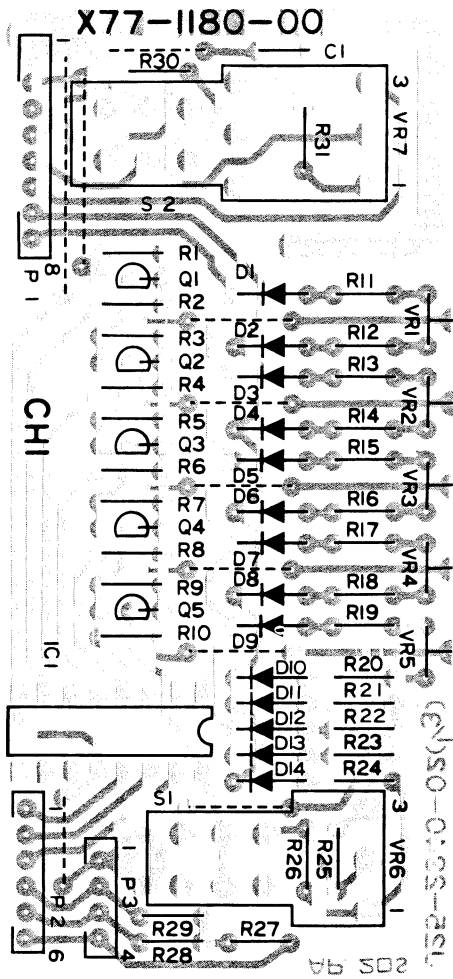
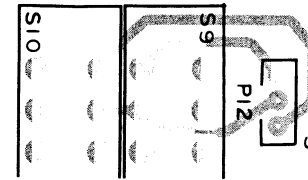
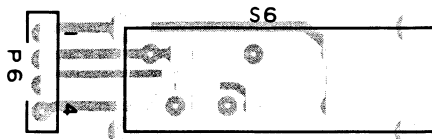
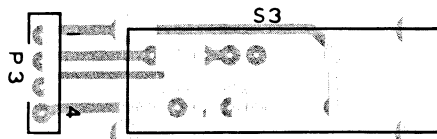

2

3

4

# P.C. BOARD

X81-1120-00

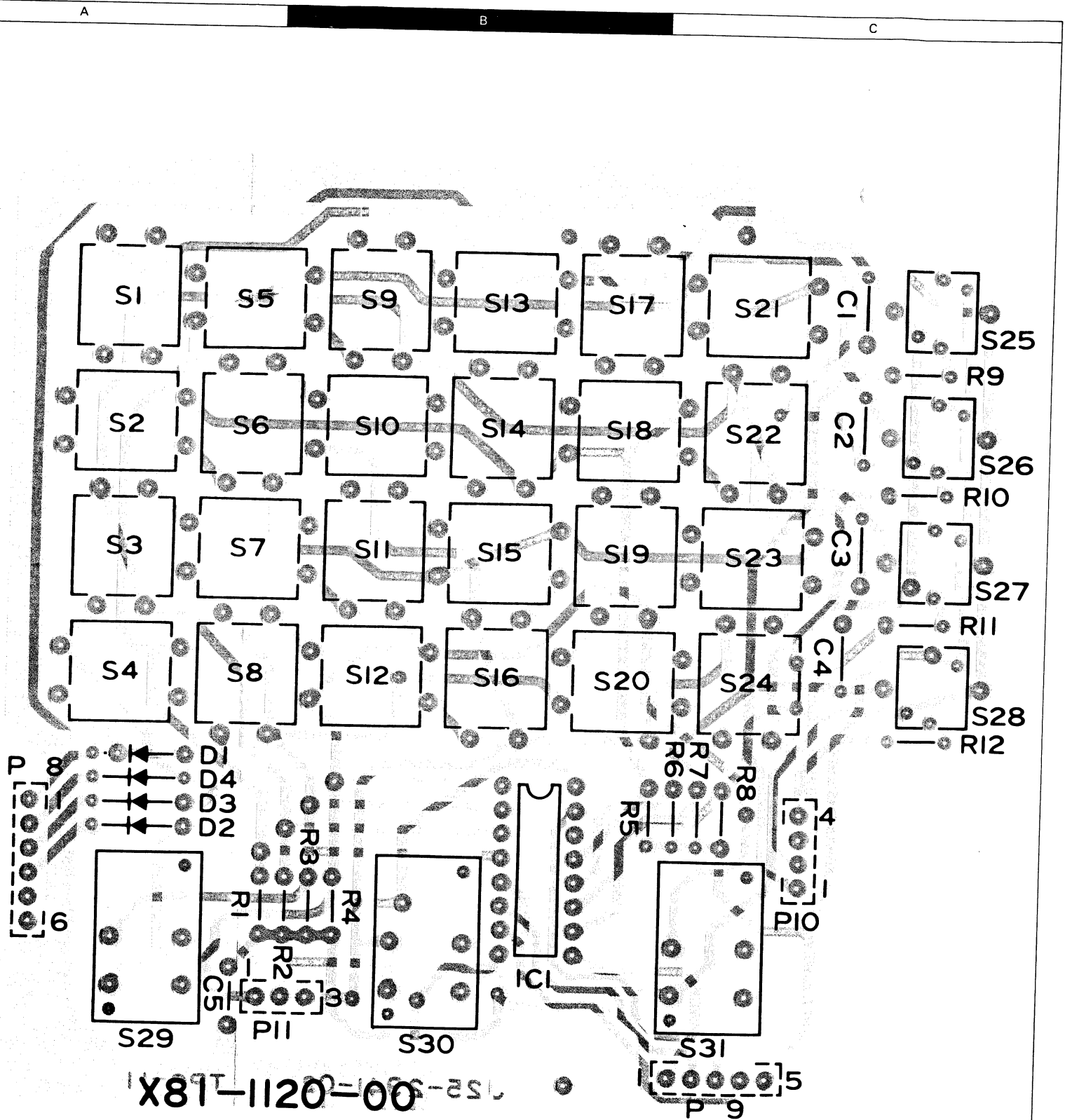

# SCHEMATIC DIAGRAM

RT-1721

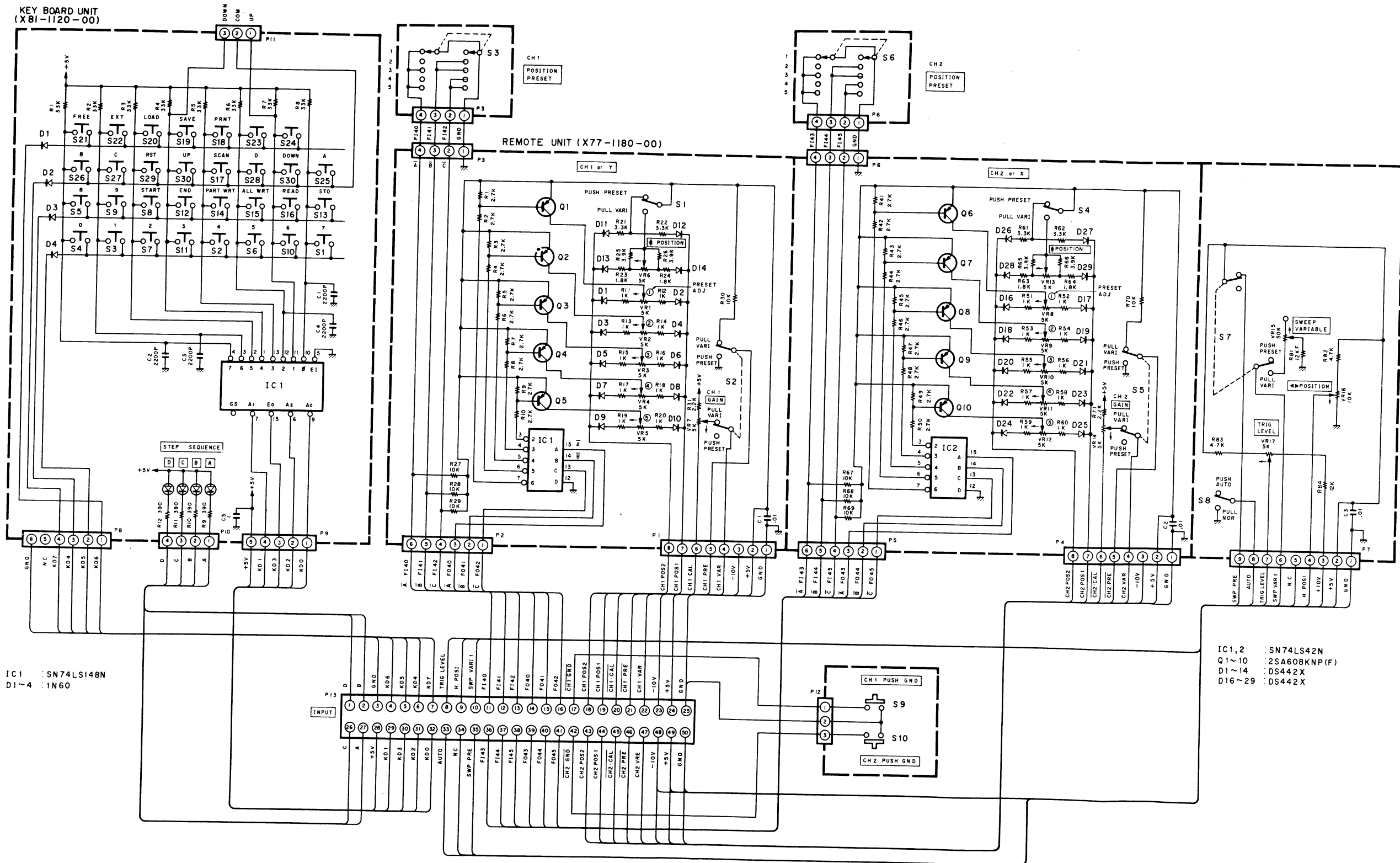

IC1 : SN74LS148N  
D1~4 : 1N60

IC1,2 : SN74LS42N  
Q1~10 : 2SA608KNP(F)  
D1~14 : DS442X  
D16~29 : DS442X