

P-XI-160

EM-AGG-X-946

VARIANTE POLARIZ FINALE
NEI TIPI A 6V

VARIANTE POLARIZZAZIONE FINALE
NEI TIPI A 24 E 48V

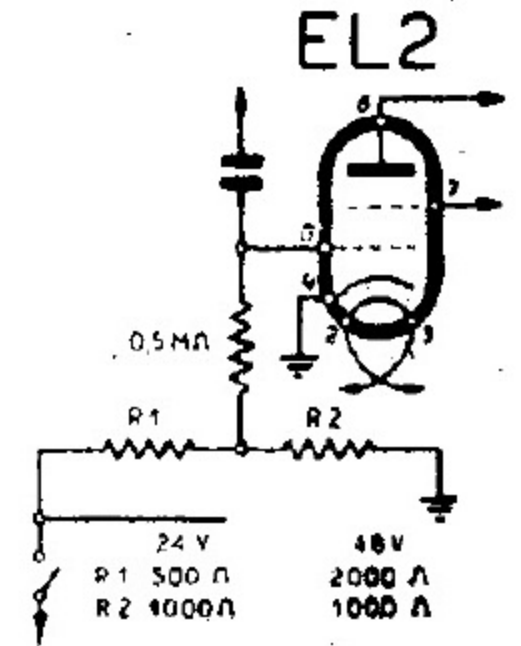
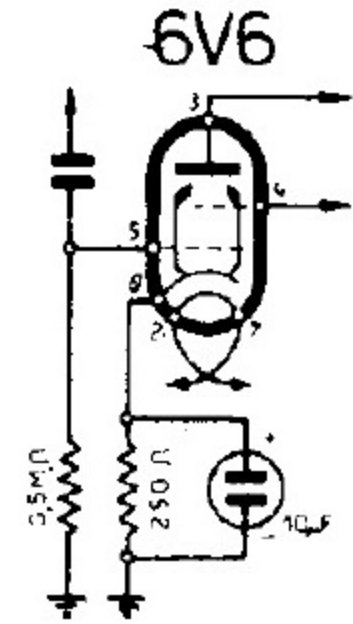
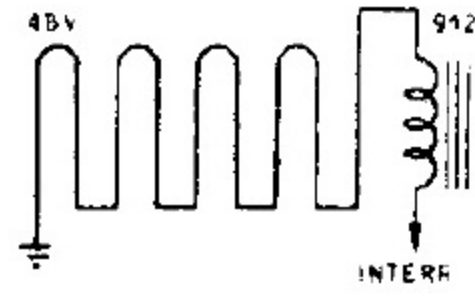
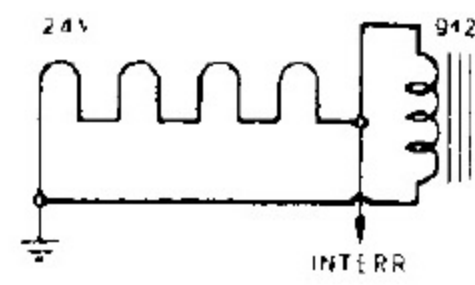
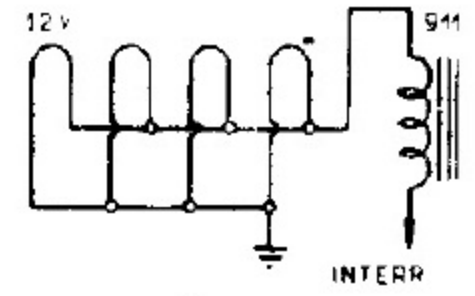
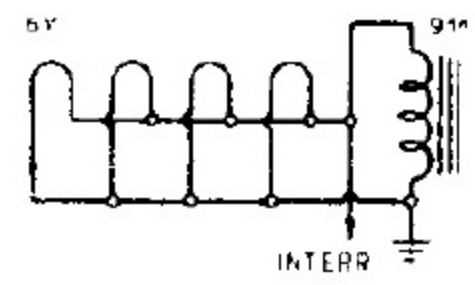
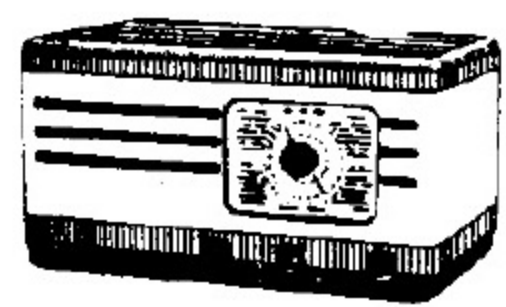

GALLO ING. G. - CONDOR MOD. « GHIBLI »