

**STK4332**

AF Power Amplifier (5W + 5W min, THD = 1.0%)

Features

- Small and slim package with 25.5 mm height.
- Capable of guaranteeing substrate temperature 125°C, thereby reducing heat sink.
- Excellent cost performance.

Package Dimensions

unit: mm

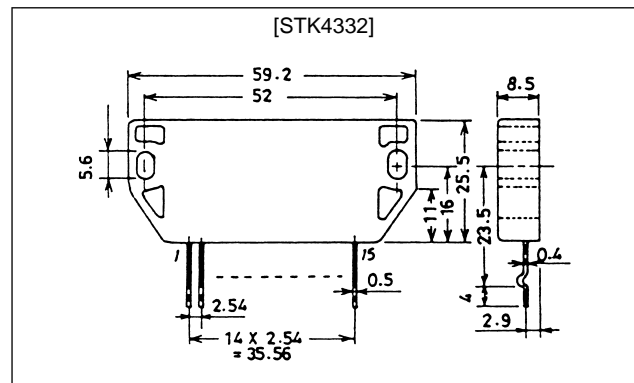
4032

Specifications

Maximum Ratings at $T_a = 25^\circ\text{C}$

Parameter	Symbol	Conditions	Ratings	Unit
Maximum supply voltage	V_{CC} max	Pin 4 to 7, 12	32	V
Thermal resistance	θ_{j-c}	One power transistor	7	$^\circ\text{C}/\text{W}$
Junction temperature	T_j		150	$^\circ\text{C}$
Operating substrate temperature	T_c		125	$^\circ\text{C}$
Storage temperature	T_{stg}		-30 to +125	$^\circ\text{C}$
Available time for load short-circuit	t_s	$V_{CC} = 23\text{V}$, $R_L = 8\Omega$, $P_O = 5\text{W}$, $f = 50\text{Hz}$	2	s

Recommended Operating Conditions at $T_a = 25^\circ\text{C}$

Parameter	Symbol	Conditions	Ratings	Unit
Recommended supply voltage	V_{CC}		23	V
Load resistance	R_L		8	Ω

Operating Characteristics at $T_a = 25^\circ\text{C}$, $V_{CC} = 23\text{V}$, $R_L = 8\Omega$, $R_g = 600\Omega$, $V_G = 40\text{ dB}$,
at specified Test Circuit (based on Sample Application Circuit).

Parameter	Symbol	Conditions	min	typ	max	Unit
Quiescent current	I_{CCO}	$V_{CC} = 27\text{V}$	20	60	120	mA
Output power	$P_O(1)$	THD = 1.0%, $f = 1\text{kHz}$	5			W
	$P_O(2)$	THD = 1.0%, $f = 60\text{Hz to } 10\text{kHz}$	2.5			W
Total harmonic distortion	THD	$P_O = 0.1\text{W}$, $f = 1\text{kHz}$			0.5	%
Frequency response	f_L, f_H	$P_O = 0.1\text{W}$, $+0$ -3 dB		50 to 50k		Hz
Input impedance	r_i	$P_O = 0.1\text{W}$, $f = 1\text{kHz}$		110k		Ω
Output noise voltage	V_{NO}	$V_{CC} = 27\text{V}$, $R_g = 10\text{k}\Omega$			0.8	mVrms

Notes. Unless otherwise specified for the power supply at the time of test, use the constant voltage power supply.
When testing the available time for load short-circuit and output noise voltage, use the specified transformer as shown right.
The output noise voltage is the peak value on the mean value indicating rms reading (VTVM), and should not involve impulse noise.

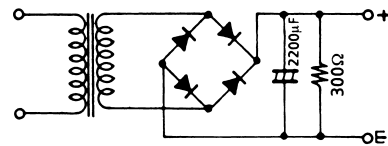

Specified Transformer Power Supply
(Equivalent to RP-22)

Equivalent Circuit

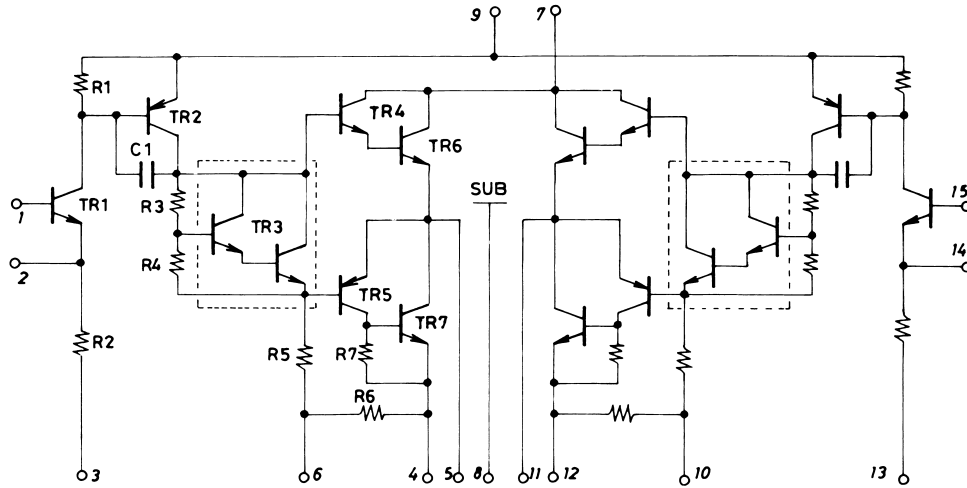

Sample Application Circuit : 5W min 2-channel AF power amplifier

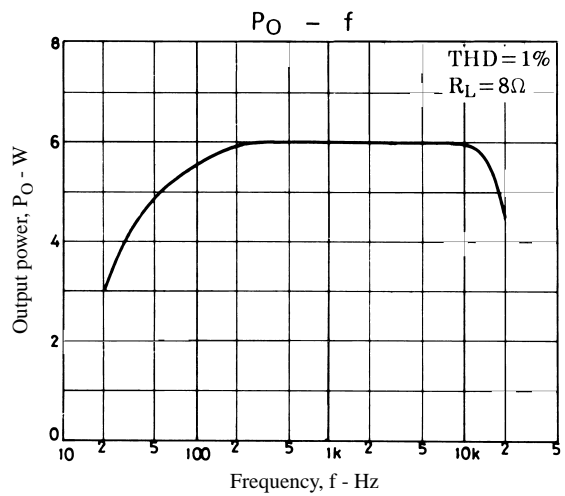
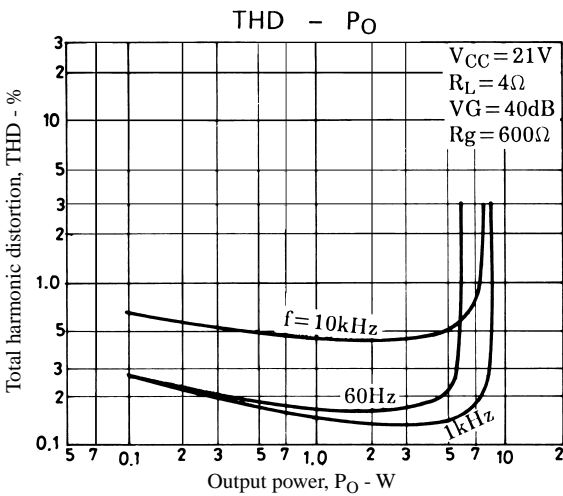
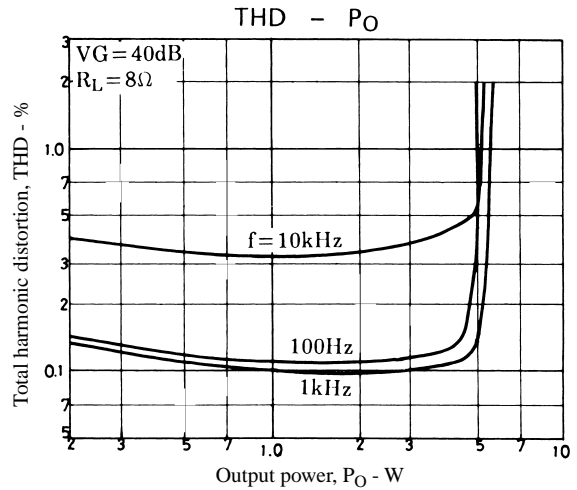
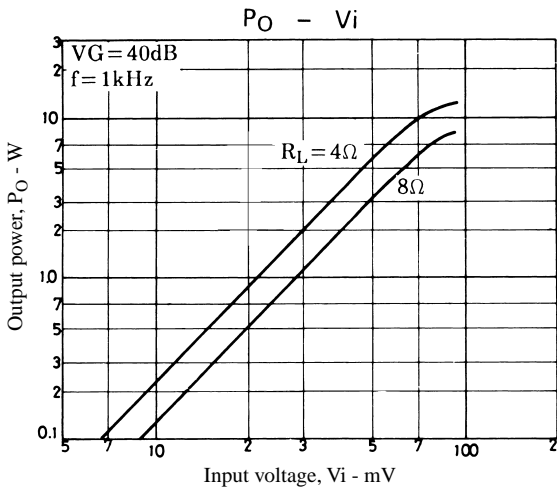
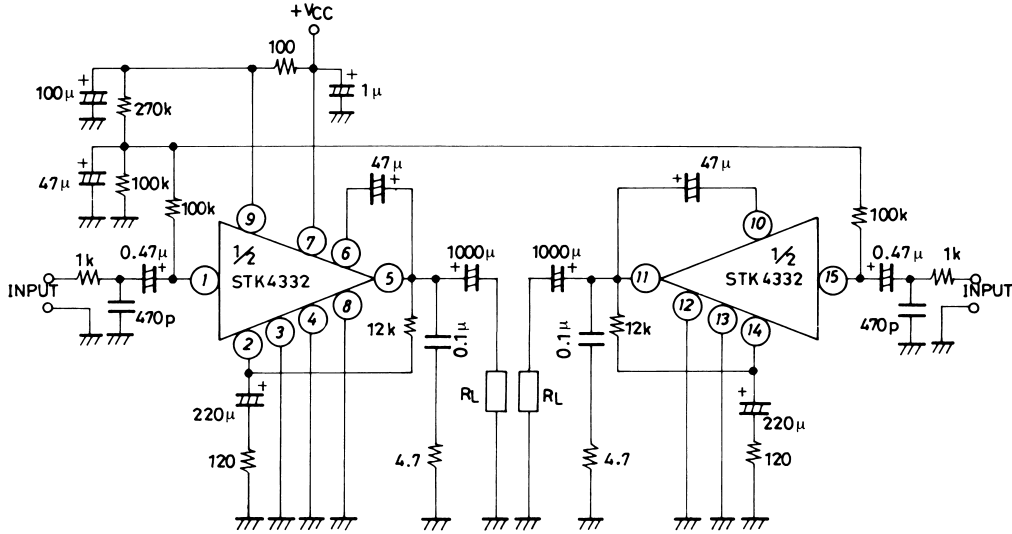

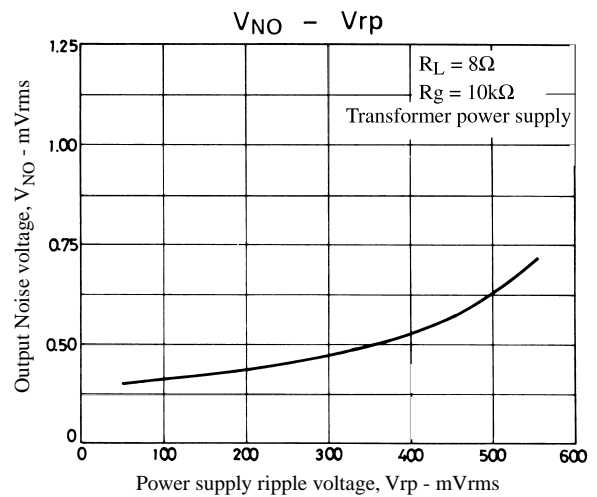
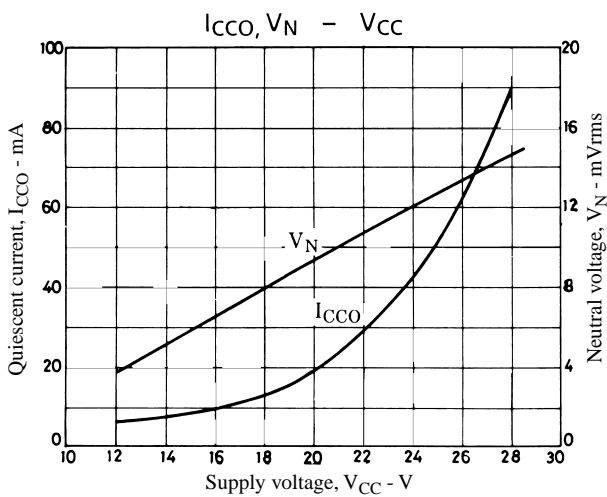
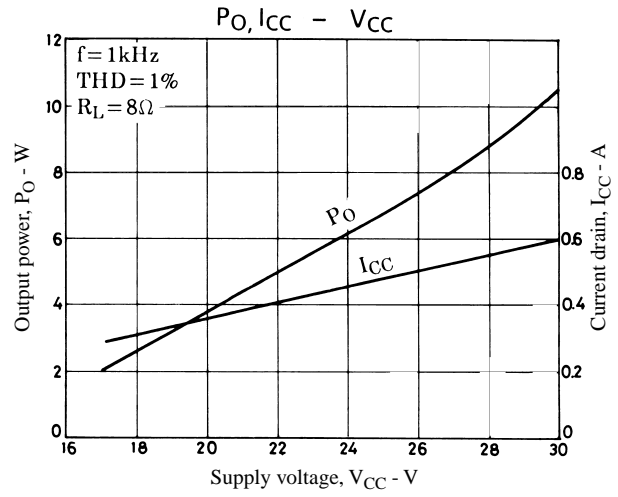
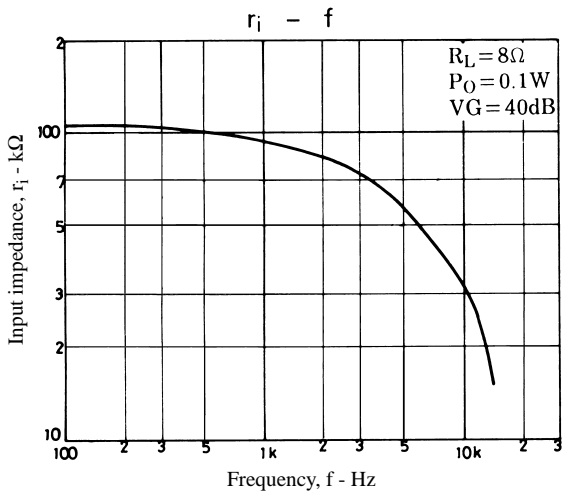
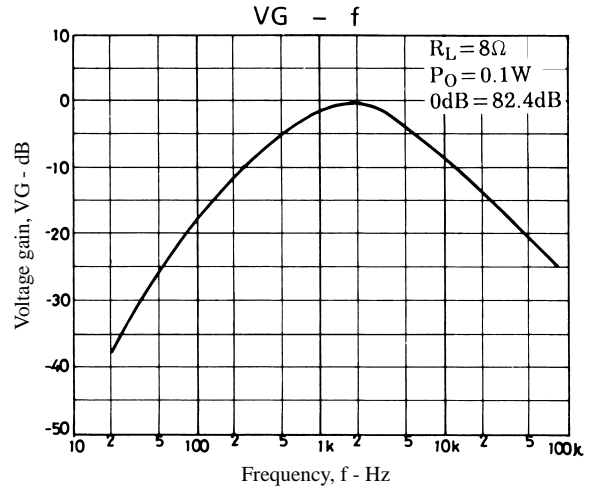
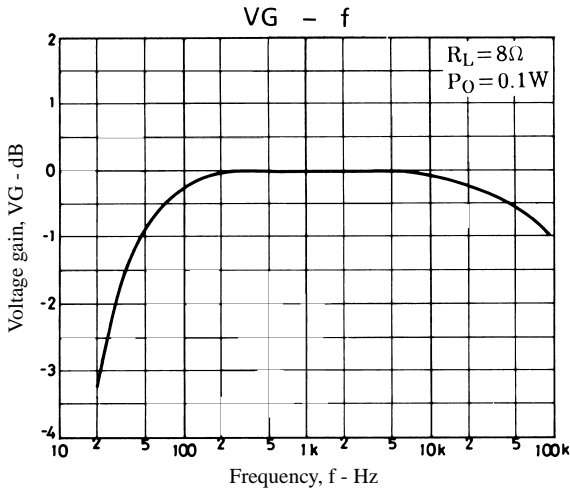

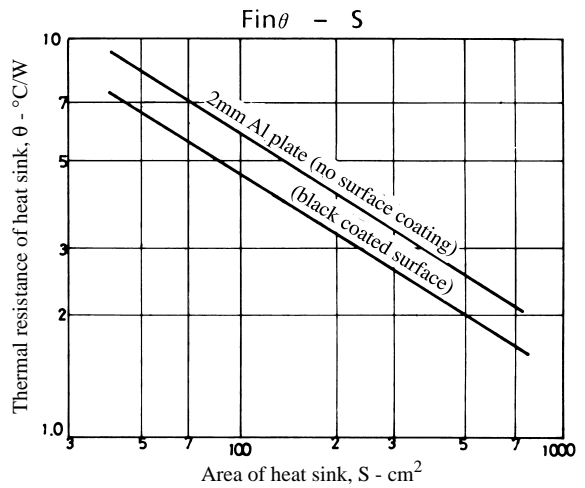
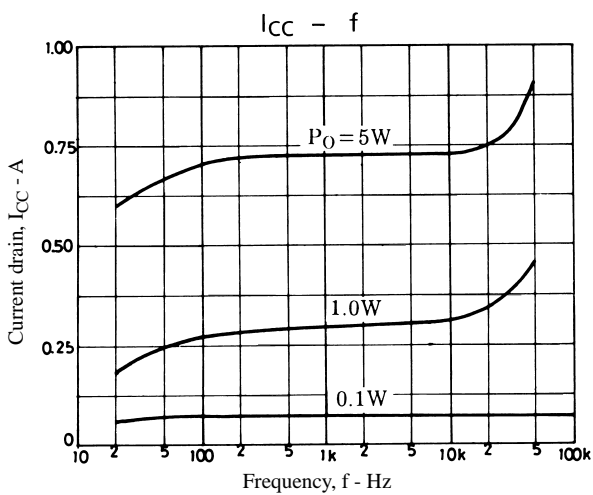
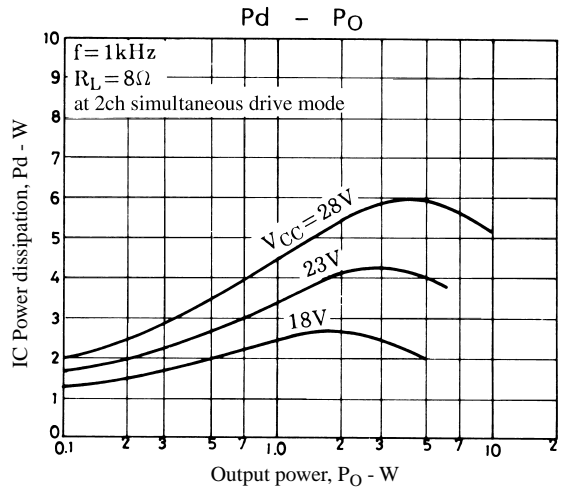
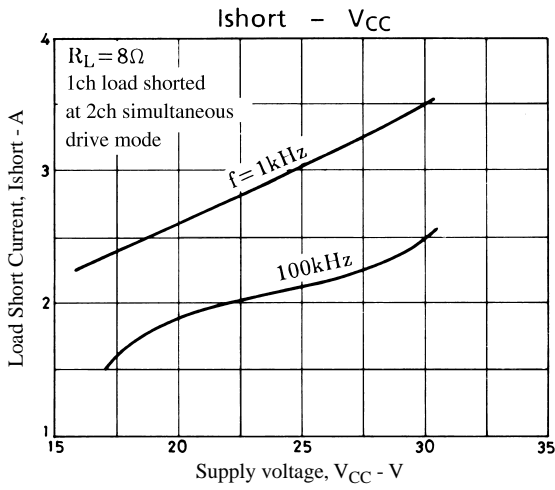
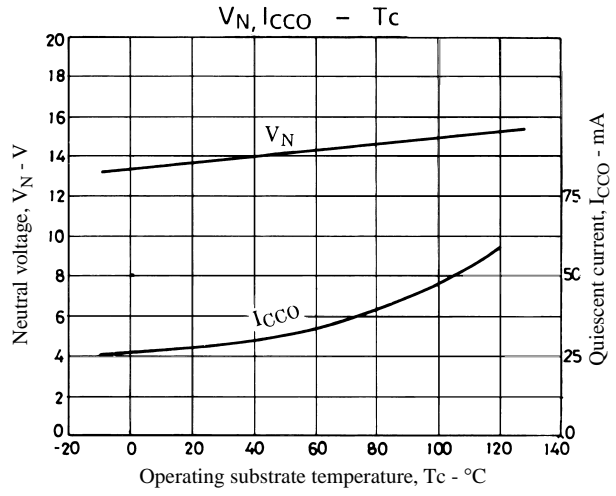
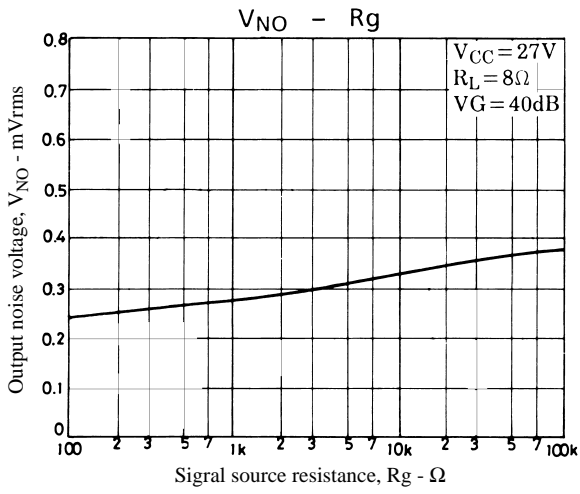

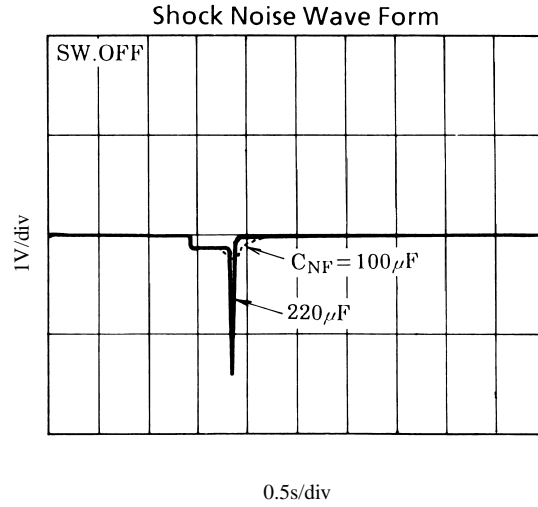
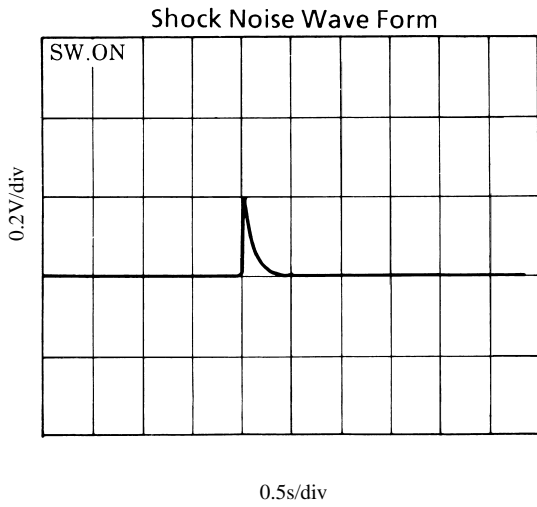

- No products described or contained herein are intended for use in surgical implants, life-support systems, aerospace equipment, nuclear power control systems, vehicles, disaster/crime-prevention equipment and the like, the failure of which may directly or indirectly cause injury, death or property loss.
- Anyone purchasing any products described or contained herein for an above-mentioned use shall:
 - ① Accept full responsibility and indemnify and defend SANYO ELECTRIC CO., LTD., its affiliates, subsidiaries and distributors and all their officers and employees, jointly and severally, against any and all claims and litigation and all damages, cost and expenses associated with such use:
 - ② Not impose any responsibility for any fault or negligence which may be cited in any such claim or litigation on SANYO ELECTRIC CO., LTD., its affiliates, subsidiaries and distributors or any of their officers and employees, jointly or severally.
- Information (including circuit diagrams and circuit parameters) herein is for example only; it is not guaranteed for volume production. SANYO believes information herein is accurate and reliable, but no guarantees are made or implied regarding its use or any infringements of intellectual property rights or other rights of third parties.