

DUAL AUDIO POWER AMPLIFIER

TA8217P is dual audio power amplifier designed for the audio power amplifier of portable radio cassette tape recorder.

FEATURES

- High Output Power : $P_{Out} = 2.5W$ (Typ.)
($V_{CC} = 9V$, $R_L = 4\Omega$, $f = 1kHz$, $THD = 10\%$)
- Soft Clip
- Built-in Thermal Shutdown Protection Circuit
- Wide Operating Supply Voltage Range
: $V_{CC} = 4.5 \sim 12V$ ($T_a = 25^\circ C$)

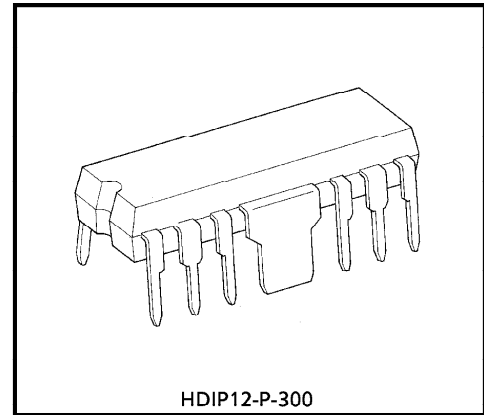

Weight : 1.4g (Typ.)

BLOCK DIAGRAM

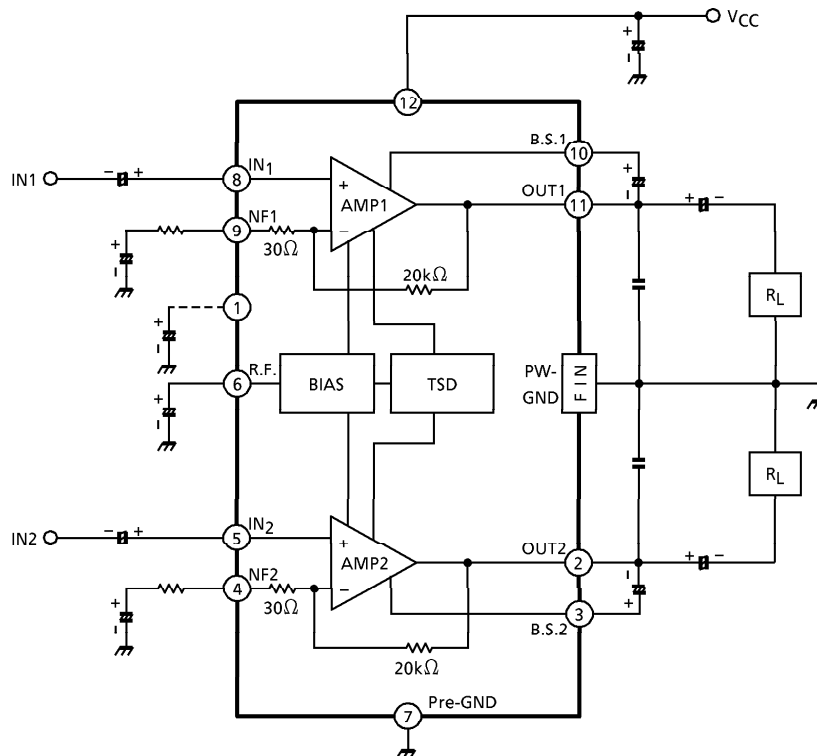

© The information contained herein is presented only as a guide for the applications of our products. No responsibility is assumed by TOSHIBA CORPORATION for any infringements of intellectual property or other rights of the third parties which may result from its use. No license is granted by implication or otherwise under any intellectual property or other rights of TOSHIBA CORPORATION or others.

© These TOSHIBA products are intended for use in general commercial applications (office equipment, communication equipment, measuring equipment, domestic appliances, etc.). please make sure that you consult with us before you use these TOSHIBA products in equipment which requires extraordinarily high quality and/or reliability, and in equipment which may involve life threatening or critical application, including but not limited to such uses as atomic energy control, airplane or spaceship instrumentation, traffic signals, medical instrumentation, combustion control, all types of safety devices, etc. TOSHIBA cannot accept and hereby disclaims liability for any damage which may occur in case the TOSHIBA products are used in such equipment or applications without prior consultation with TOSHIBA.

PRECAUTIONS FOR USE AND APPLICATION

(1) Input stage

The input stage of power amplifier is comprised of a PNP differential pair preceded by a PNP emitter follower which allows DC referencing of the source signal to ground. This eliminates the need for an input coupling capacitor. However, in case the brush noise of volume becomes a problem, provide serially a coupling capacitor to the input side.

(2) Adjustment of voltage gain

The voltage gain is fixed at $G_V \doteq 56.5\text{dB}$ by the resistors (R_1 and R_2) in IC, however, its reduction is possible through adding R_f as shown in Fig.1. In this case, the voltage gain is obtained by the following equation.

$$G_V \doteq 20 \log \frac{R_1 + R_2 + R_f}{R_1 + R_f}$$

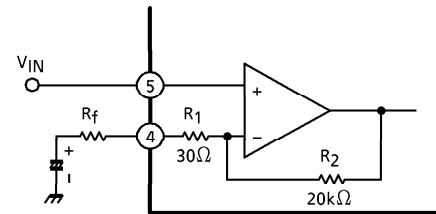

Fig.1

It is recommended to use this IC with the voltage gain of $G_V = 40\text{dB}$ or over.

(3) Measures against oscillation

For the capacitors C_6 and C_7 to be applied for preventing the oscillation between output terminal and GND, use the polyester film capacitor having superior quality in high frequency and temperature characteristics, however, since the characteristics of the capacitor may be different depending on the manufactures or kinds, apply the capacitor after confirmation.

Since the characteristics of the capacitor of the ceramic Type are liable to be affected by the temperature and the voltage, use the capacitor of larger capacity and be sure to perform the thermal test to check the oscillation allowance.

MAXIMUM RATINGS ($T_a = 25^\circ\text{C}$)

CHARACTERISTIC	SYMBOL	RATING	UNIT
Supply Voltage	V_{CC}	20	V
Power Dissipation (Package Limitation)	P_D (Note 1)	4.0	W
Output Current	I_O	2.5	A
Operating Temperature	T_{opr}	-20~75	$^\circ\text{C}$
Storage Temperature	T_{stg}	-55~150	$^\circ\text{C}$

(Note 1) Value for mounting on PC board (Refer to $P_D - T_a$ curve)

ELECTRICAL CHARACTERISTICS

(Unless otherwise specified, $V_{CC} = 9\text{V}$, $R_L = 4\Omega$, $R_g = 600\Omega$, $f = 1\text{kHz}$, $T_a = 25^\circ\text{C}$)

CHARACTERISTIC	SYMBOL	TEST CIRCUIT	TEST CONDITION	MIN.	TYP.	MAX.	UNIT
Quiescent Current	I_{CCQ}	—	$V_{in} = 0$	—	23	55	mA
Output Power	$P_{out(1)}$	—	THD = 10%	2.0	2.5	—	W
	$P_{out(2)}$	—	THD = 10%, $R_L = 3\Omega$	—	2.9	—	
	$P_{out(3)}$	—	THD = 10%, $V_{CC} = 6\text{V}$	—	1.0	—	
Total Harmonic Distortion	THD	—	$P_{out} = 0.4\text{W}$, $G_V = 45\text{dB}$	—	0.2	1.2	%
Voltage Gain	$G_V(1)$	—	$R_f = 82\Omega$, $V_{out} = 0.775V_{rms}$ (0dBm)	43	45	47	dB
	$G_V(2)$	—	$R_f = 0$, $V_{out} = 0.775V_{rms}$ (0dBm)	—	56	—	
Cross Talk	C.T.	—	$R_g = 600\Omega$, $V_{out} = 0.775V_{rms}$ (0dBm)	—	-60	—	dB
Ripple Rejection Ratio	R.R.	—	$R_g = 600\Omega$, $V_{ripple} = 0.245V_{rms}$ (-10dBm) $f_{ripple} = 100\text{Hz}$	—	-52	-45	dB
Output Noise Voltage	V_{no}	—	$R_g = 10\text{k}\Omega$, $G_V = 45\text{dB}$ $B_{VV} = 20\sim 20\text{kHz}$	—	0.35	1.0	mV_{rms}
Input Resistance	R_{IN}	—	—	—	30	—	$\text{k}\Omega$
Input Offset Voltage	V_5, V_8	—	$V_{in} = 0$	—	20	—	mW

TYP. DC VOLTAGE OF EACH TERMINAL ($V_{CC} = 9\text{V}$, $T_a = 25^\circ\text{C}$ by test circuit)

TERMINAL No.	1	2	3	4	5	6	7	8	9	10	11	12
DC Voltage (V)	8.1	4.5	8.8	0.6	0.02	8.9	0	0.02	0.6	8.8	4.5	9.0

TEST CIRCUIT

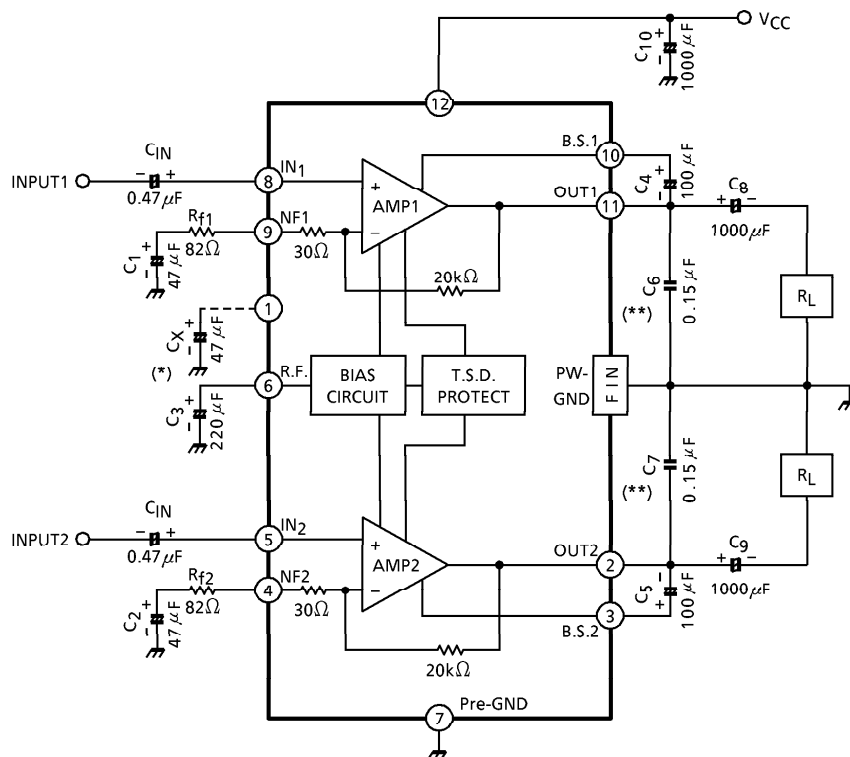

(*) C_X is a ripple filter capacitor for transition duration when supply voltage and pin① voltage are inverted.

(**) For C_6 and C_7 , it is advised to use polyester film capacitor having superior quality in the characteristics of high frequency and temperature.

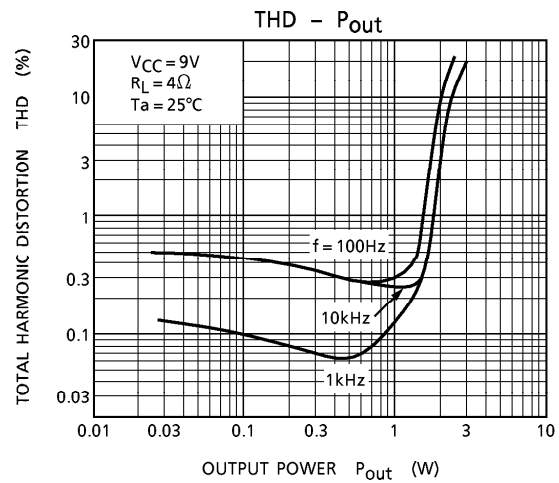
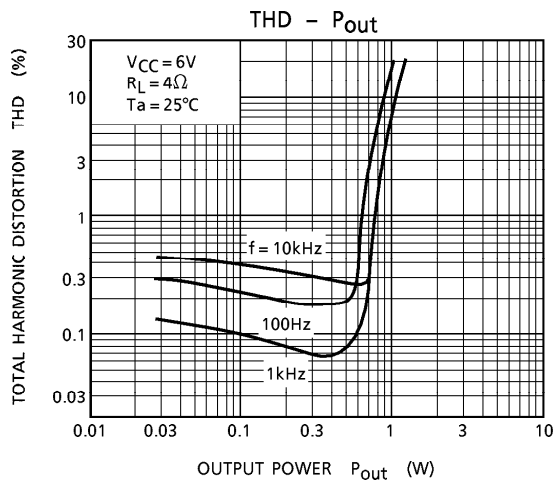
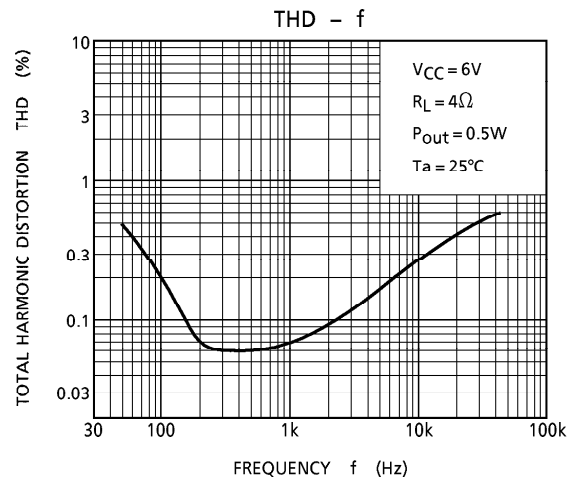
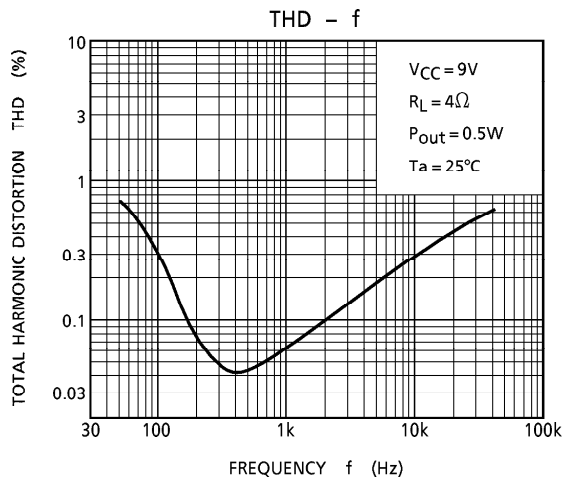
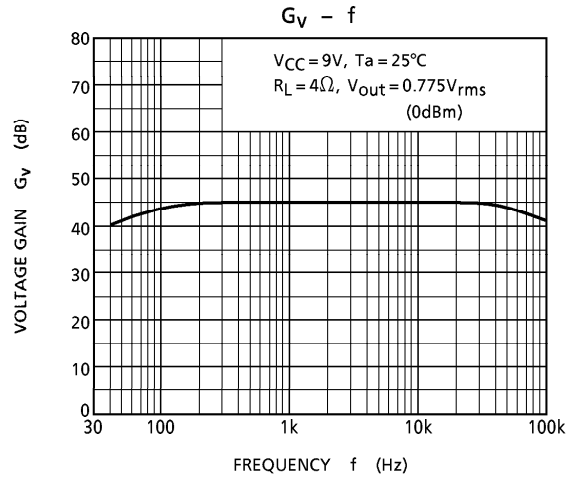
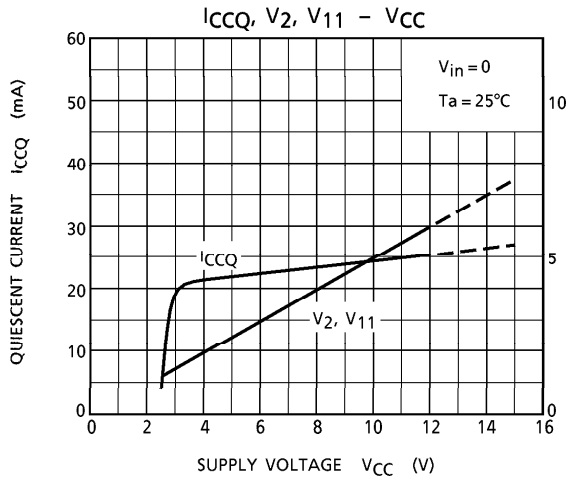

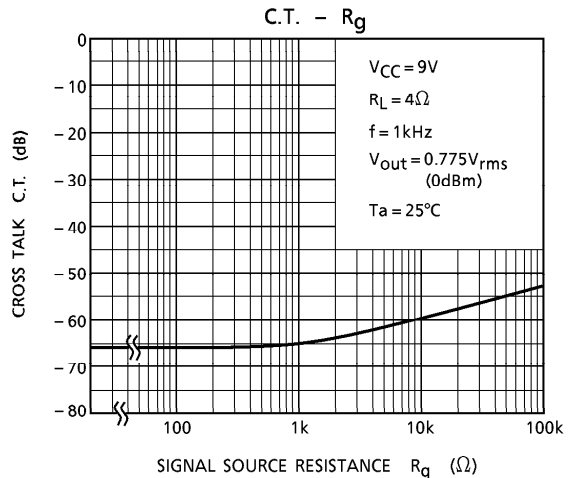
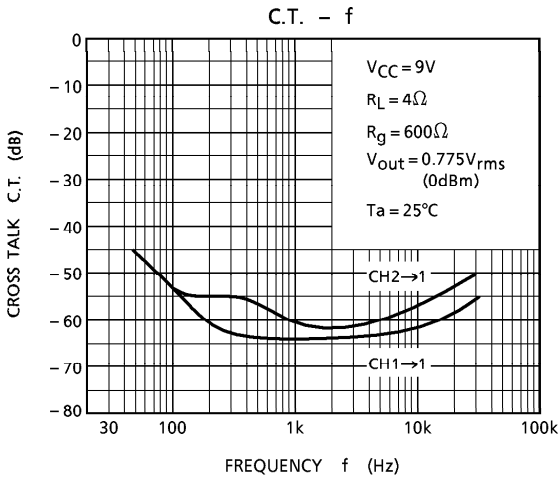
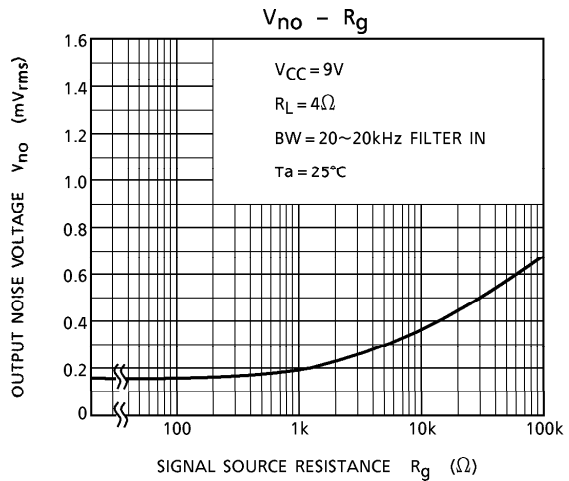
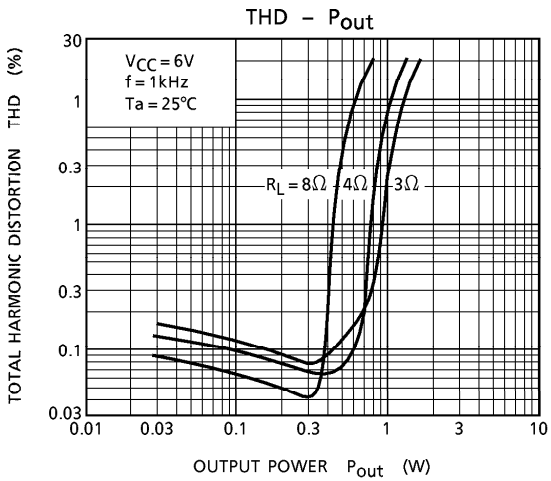
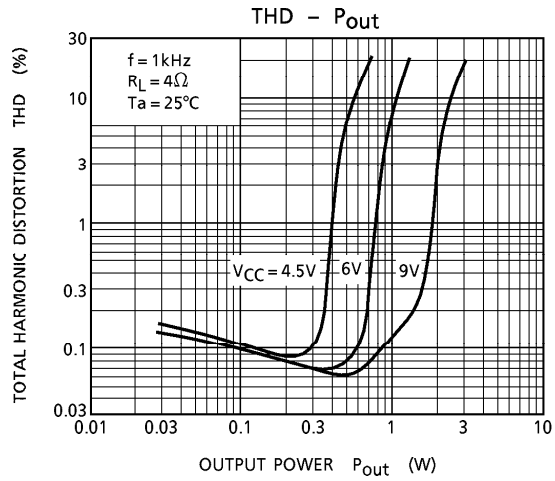
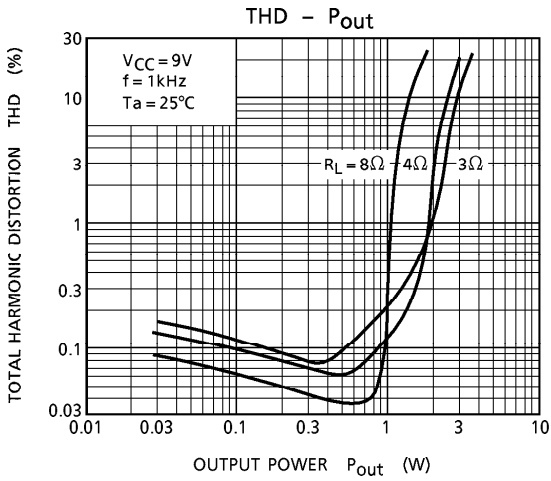

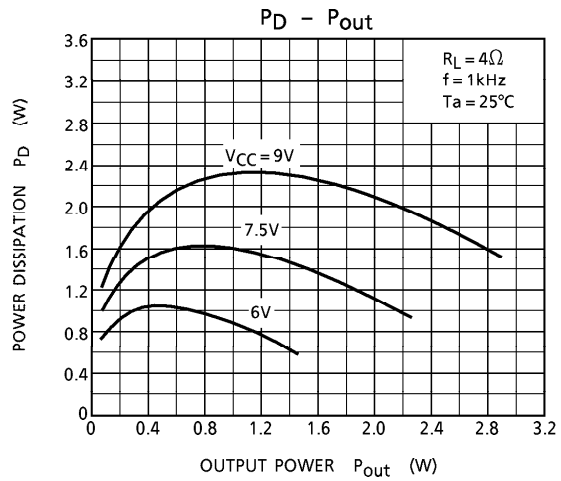
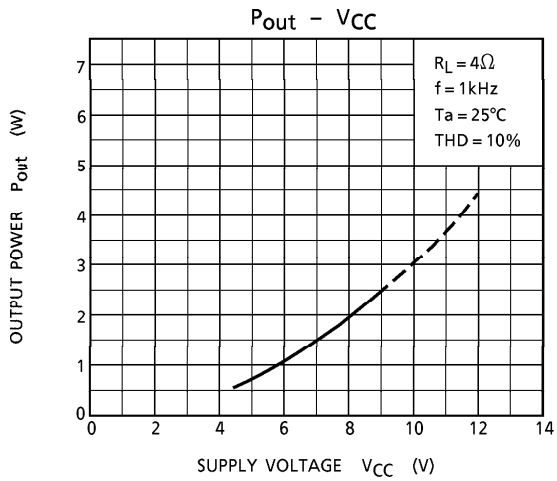
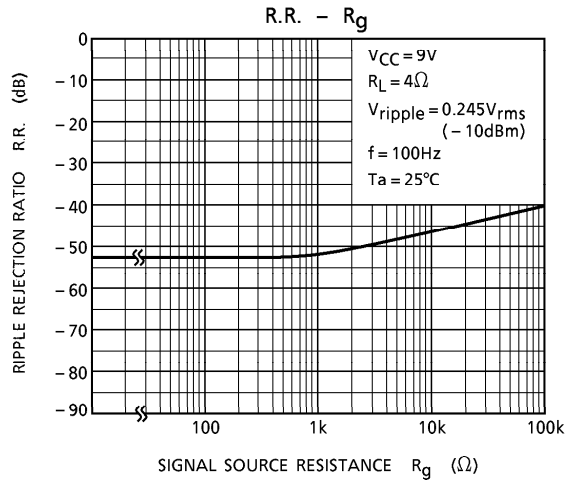
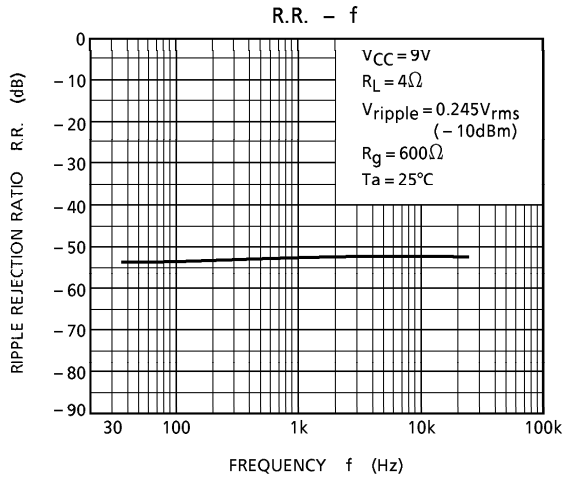

HEAT SINK

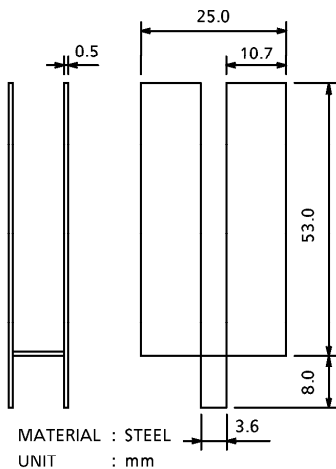

RECOMMENDED PCB LAYOUT

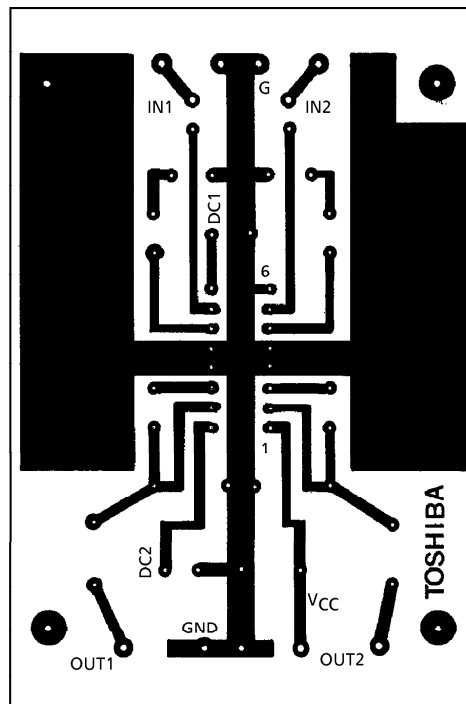

PCB : EPOXY GLASS
80mm x 60mm x 1.2mm

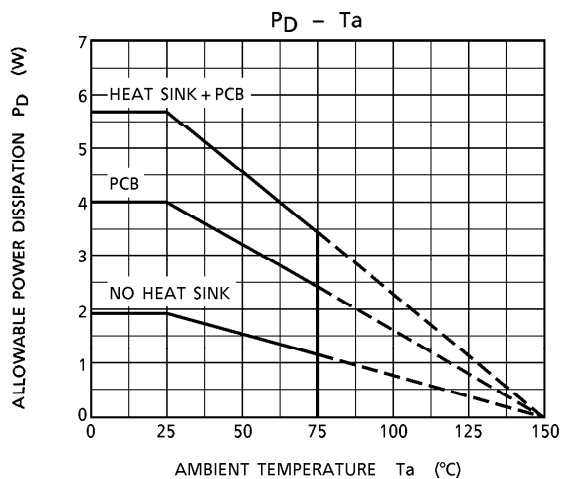

OUTLINE DRAWING
HDIP12-P-300

Unit : mm

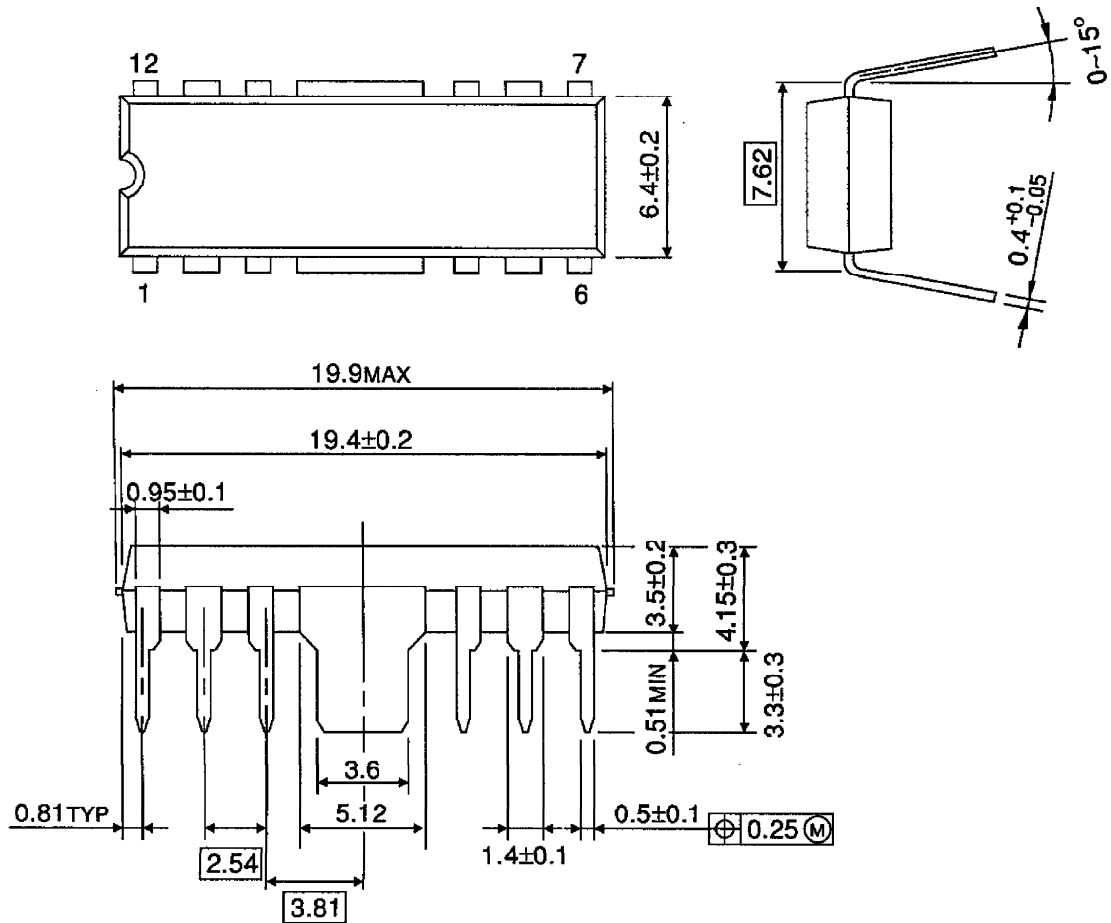

Weight : 1.4g (Typ.)

TA8217P - 9*
1996 - 6 - 17
TOSHIBA CORPORATION