



4 x 35W QUAD BRIDGE CAR RADIO AMPLIFIER

- HIGH OUTPUT POWER CAPABILITY:
 - 4 x 40W/4Ω MAX.
 - 4 x 35W/4Ω EIAJ
 - 4 x 25W/4Ω @ 14.4V, 1KHz, 10%
 - 4 x 22W/4Ω @ 13.2V, 1KHz, 10%
- LOW DISTORTION
- LOW OUTPUT NOISE
- ST-BY FUNCTION
- MUTE FUNCTION
- AUTOMUTE AT MIN. SUPPLY VOLTAGE DETECTION
- LOW EXTERNAL COMPONENT COUNT:
 - INTERNALLY FIXED GAIN (26dB)
 - NO EXTERNAL COMPENSATION
 - NO BOOTSTRAP CAPACITORS

PROTECTIONS:

- OUTPUT SHORT CIRCUIT TO GND, TO V_S , ACROSS THE LOAD
- VERY INDUCTIVE LOADS
- OVERRATING CHIP TEMPERATURE WITH SOFT THERMAL LIMITER
- LOAD DUMP VOLTAGE

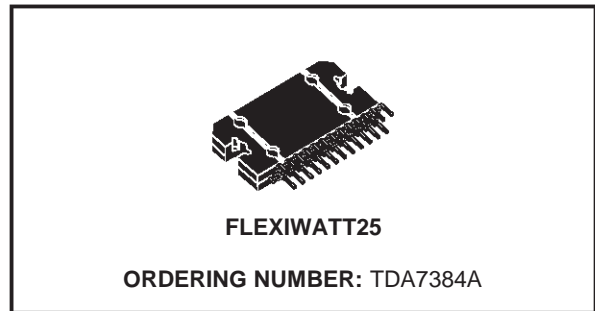

- FORTUITOUS OPEN GND
- REVERSED BATTERY
- ESD

DESCRIPTION

The TDA7384A is a new technology class AB Audio Power Amplifier in Flexiwatt 25 package designed for high end car radio applications.

Thanks to the fully complementary PNP/NPN output configuration the TDA7384A allows a rail to rail output voltage swing with no need of bootstrap capacitors. The extremely reduced components count allows very compact sets.

BLOCK AND APPLICATION DIAGRAM

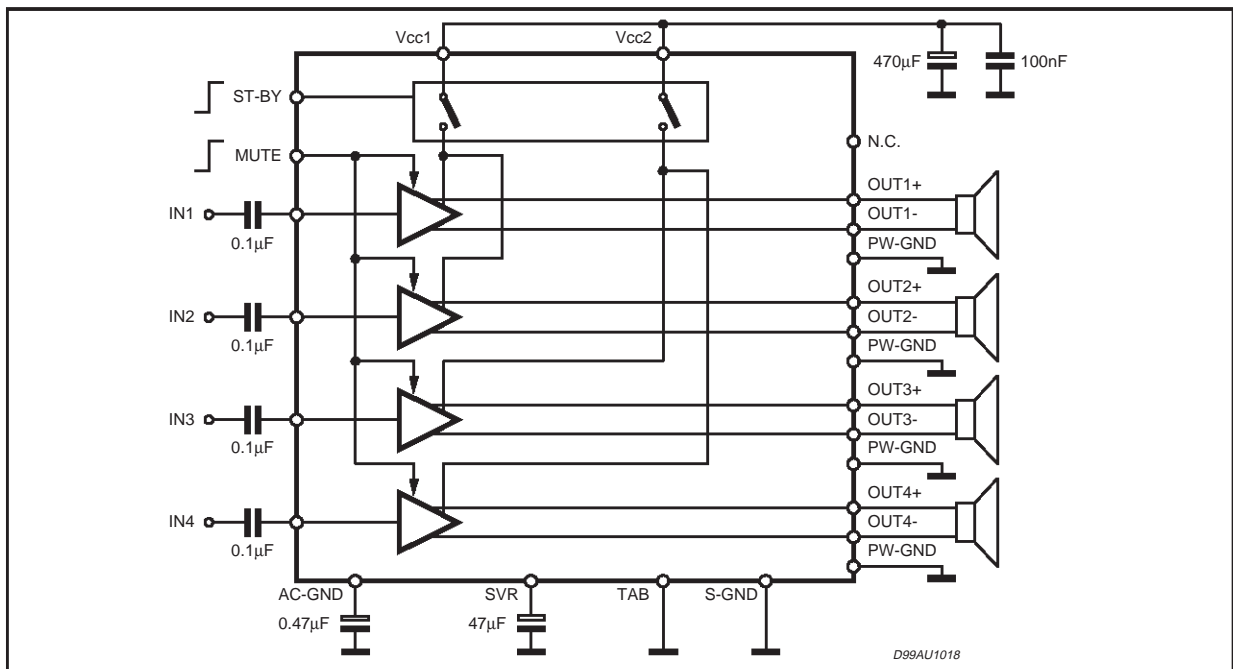

TDA7384A

ABSOLUTE MAXIMUM RATINGS

Symbol	Parameter	Value	Unit
V_{CC}	Operating Supply Voltage	18	V
$V_{CC(DC)}$	DC Supply Voltage	28	V
$V_{CC(pk)}$	Peak Supply Voltage (t = 50ms)	50	V
I_o	Output Peak Current: Repetitive (Duty Cycle 10% at f = 10Hz)	4.5	A
	Non Repetitive (t = 100 μ s)	5.5	A
P_{tot}	Power dissipation, (T _{case} = 70°C)	80	W
T_j	Junction Temperature	150	°C
T_{stg}	Storage Temperature	- 55 to 150	°C

PIN CONNECTION (Top view)

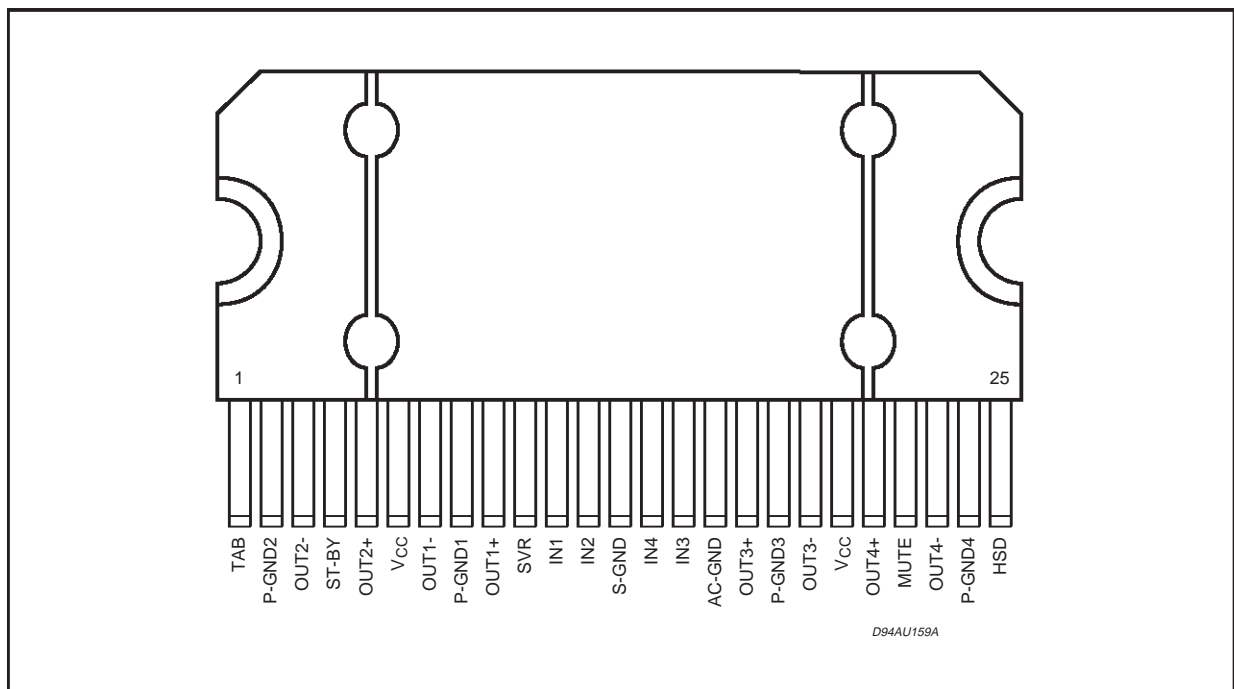

THERMAL DATA

Symbol	Parameter	Value	Unit
$R_{th j-case}$	Thermal Resistance Junction to Case	Max. 1	°C/W

ELECTRICAL CHARACTERISTICS ($V_S = 14.4V$; $f = 1KHz$; $R_g = 600\Omega$; $R_L = 4\Omega$; $T_{amb} = 25^\circ C$;
Refer to the test and application diagram, unless otherwise specified.)

Symbol	Parameter	Test Condition	Min.	Typ.	Max.	Unit
I_{q1}	Quiescent Current	$R_L = \infty$	120	190	350	mA
V_{OS}	Output Offset Voltage	Play Mode			± 80	mV
dV_{OS}	During mute ON/OFF output offset voltage				± 80	mV
G_v	Voltage Gain		25	26	27	dB
dG_v	Channel Gain Unbalance				± 1	dB
P_o	Output Power	$V_S = 13.2V$; THD = 10% $V_S = 13.2V$; THD = 0.8% $V_S = 14.4V$; THD = 10%	20 15 24	22 17 26		W W W
P_o EIAJ	EIAJ Output Power (*)	$V_S = 13.7V$	32	35		W
P_o max.	Output Power (*)	$V_S = 14.4V$	38	40		W
THD	Distortion	$P_o = 4W$		0.04	0.15	%
e_{No}	Output Noise	"A Weighted" Bw = 20Hz to 20KHz		50 70	70 100	μV μV
SVR	Supply Voltage Rejection	$f = 100Hz$; $V_r = 1V_{rms}$	50	65		dB
f_{ch}	High Cut-Off Frequency	$P_o = 0.5W$	100	200		KHz
R_i	Input Impedance		70	100		K Ω
C_T	Cross Talk	$f = 1KHz$ $P_o = 4W$ $f = 10KHz$ $P_o = 4W$	60 50	70 60	- -	dB dB
I_{SB}	St-By Current Consumption	$V_{St-By} = 1.5V$			100	μA
I_{pin4}	St-by pin Current	$V_{St-By} = 1.5V$ to $3.5V$			± 10	μA
$V_{SB\ out}$	St-By Out Threshold Voltage	(Amp: ON)	3.5			V
$V_{SB\ in}$	St-By in Threshold Voltage	(Amp: OFF)			1.5	V
A_M	Mute Attenuation	$P_{Oref} = 4W$	80	90		dB
$V_{M\ out}$	Mute Out Threshold Voltage	(Amp: Play)	3.5			V
$V_{M\ in}$	Mute In Threshold Voltage	(Amp: Mute)			1.5	V
$V_{AM\ in}$	V_S Automute Threshold	(Amp: Mute) Att $\geq 80dB$; $P_{Oref} = 4W$ (Amp: Play) Att $< 0.1dB$; $P_o = 0.5W$			6.5	V
I_{pin22}	Muting Pin Current	$V_{MUTE} = 1.5V$ (Sourced Current)	5	11	20	μA

(*) Saturated square wave output.

Figure 1: Standard Test and Application Circuit

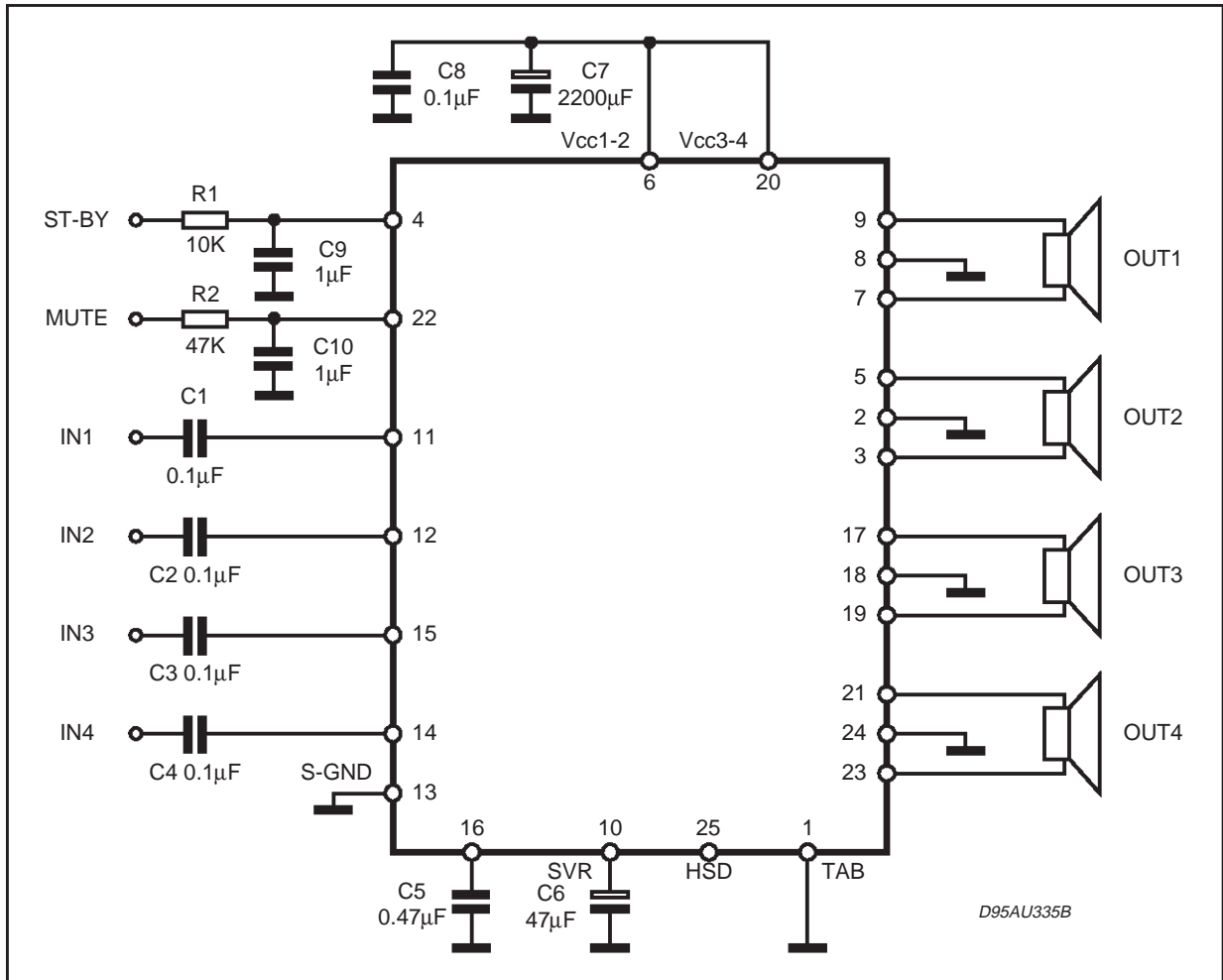

Figure 2: P.C.B. and component layout of the figure 1 (1:1 scale)

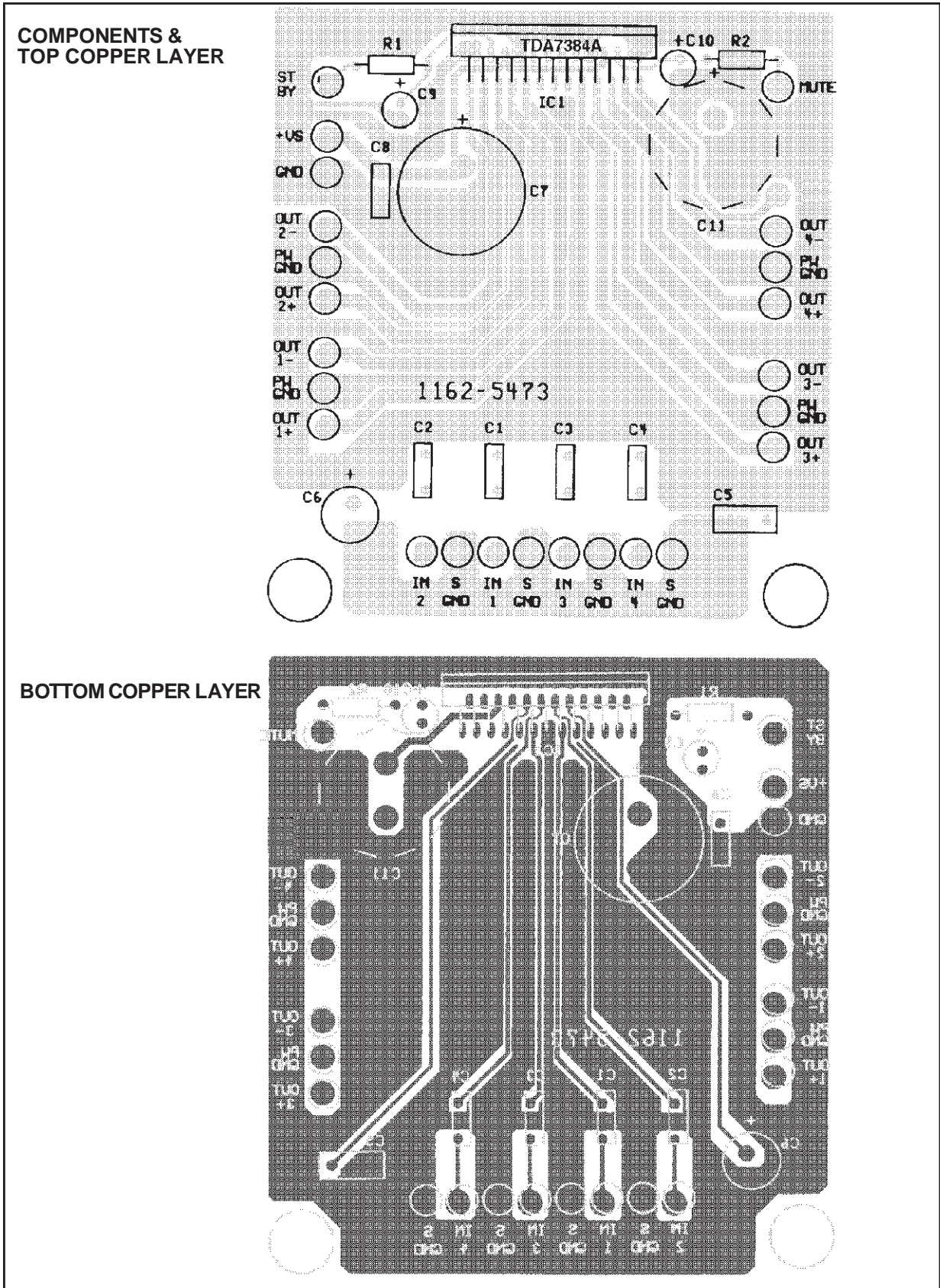

Figure 3: Quiescent Current vs. Supply Voltage

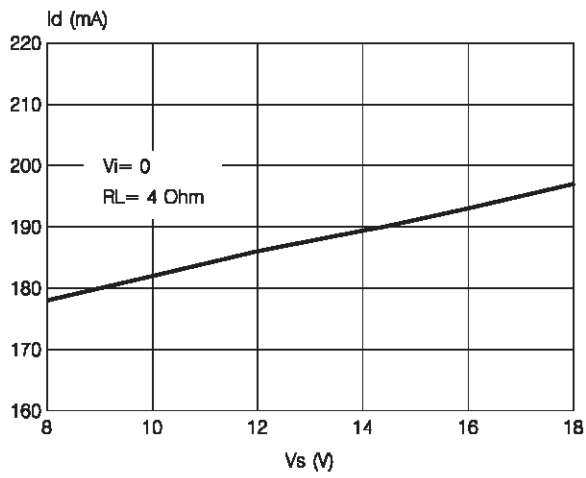

Figure 4: Quiescent Output Voltage vs. Supply Voltage

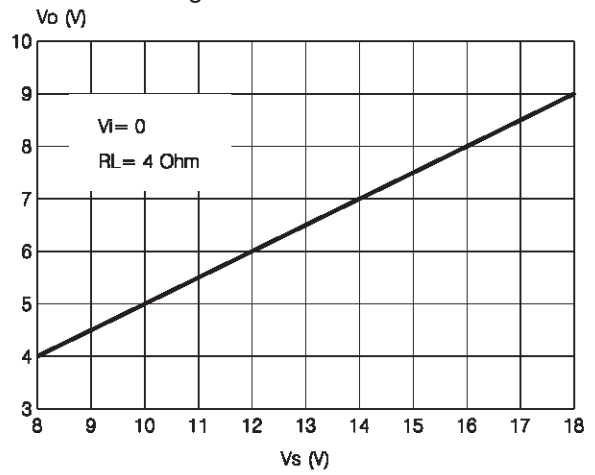

Figure 5: Output Power vs. Supply Voltage

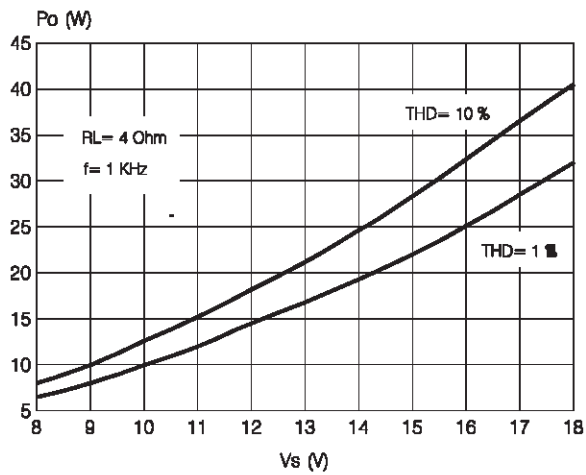

Figure 6: Distortion vs. Output Power

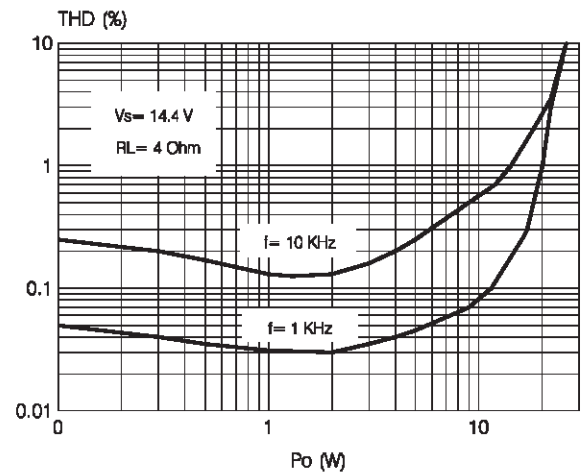

Figure 7: Distortion vs. Frequency

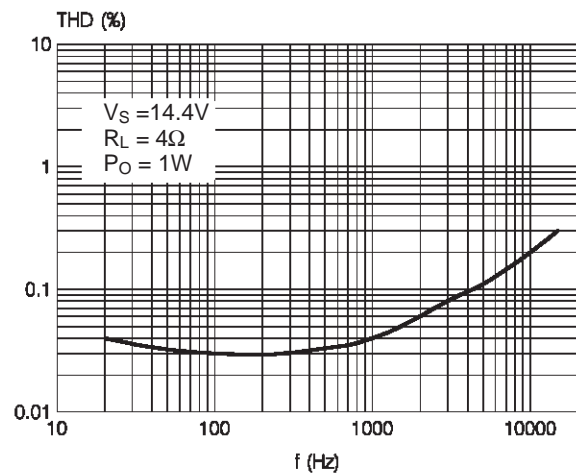

Figure 8: Supply Voltage Rejection vs. Frequency.

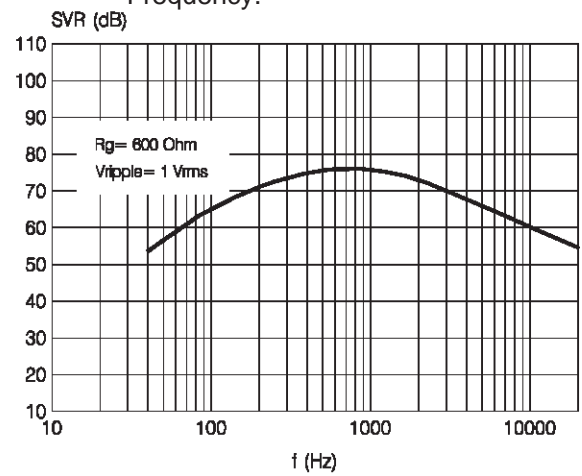
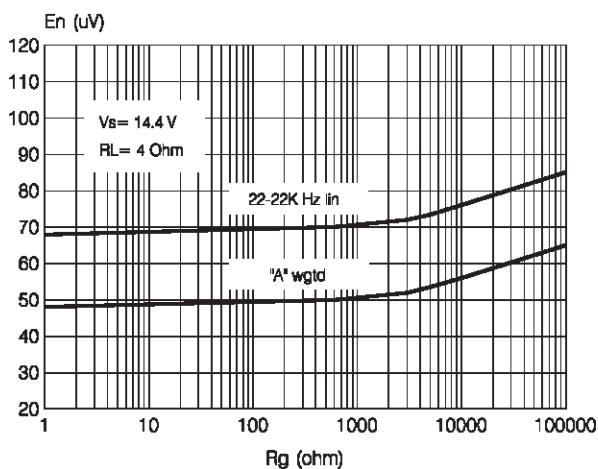

Figure 9: Output Noise vs. Source Resistance**APPLICATION HINTS** (ref. to the circuit of fig. 1)**SVR**

Besides its contribution to the ripple rejection, the SVR capacitor governs the turn ON/OFF time sequence and, consequently, plays an essential role in the pop optimization during ON/OFF transients. To conveniently serve both needs, **ITS MINIMUM RECOMMENDED VALUE IS 10 μ F**.

INPUT STAGE

The TDA7384A'S inputs are ground-compatible and can stand very high input signals (± 8 Vpk) without any performances degradation.

If the standard value for the input capacitors (0.1 μ F) is adopted, the low frequency cut-off will amount to 16 Hz.

STAND-BY AND MUTING

STAND-BY and MUTING facilities are both

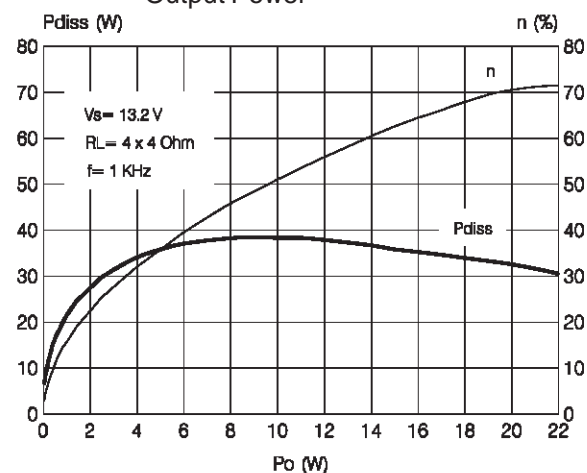
Figure 10: Power Dissipation & Efficiency vs. Output Power

CMOS-COMPATIBLE. If unused, a straight connection to V_s of their respective pins would be admissible. Conventional/low-power transistors can be employed to drive muting and stand-by pins in absence of true CMOS ports or microprocessors.

R-C cells have always to be used in order to smooth down the transitions for preventing any audible transient noises.

Since a DC current of about 10 μ A normally flows out of pin 22, the maximum allowable muting-series resistance (R_2) is 70K Ω , which is sufficiently high to permit a muting capacitor reasonably small (about 1 μ F).

If R_2 is higher than recommended, the involved risk will be that the voltage at pin 22 may rise to above the 1.5 V threshold voltage and the device will consequently fail to turn OFF when the mute line is brought down.

About the stand-by, the time constant to be assigned in order to obtain a virtually pop-free transition has to be slower than 2.5V/ms.

TDA7384A

DIM.	mm			inch		
	MIN.	TYP.	MAX.	MIN.	TYP.	MAX.
A	4.45		4.65	0.175		0.183
B	1.80	1.90	2.00	0.070	0.074	0.079
C		1.40			0.055	
D	0.75	0.90	1.05	0.029	0.035	0.041
E	0.37	0.39	0.42	0.014	0.015	0.016
F			0.57			0.022
G	0.80	1.00	1.20	0.031	0.040	0.047
G1	23.75	24.00	24.25	0.935	0.945	0.955
H	28.90	29.23	29.30	1.138	1.150	1.153
H1		17.00			0.669	
H2		12.80			0.503	
H3		0.80			0.031	
L	21.57	21.97	22.37	0.849	0.865	0.880
L1	18.57	18.97	19.37	0.731	0.786	0.762
L2	15.50	15.70	15.90	0.610	0.618	0.626
L3	7.70	7.85	7.95	0.303	0.309	0.313
M	3.70	4.00	4.30	0.145	0.157	0.169
M1	3.60	4.00	4.40	0.142	0.157	0.173
N		2.20			0.086	
O		2			0.079	
R		1.70			0.067	
R4		0.50			0.019	
V2				20°		
V3				45°		

OUTLINE AND MECHANICAL DATA

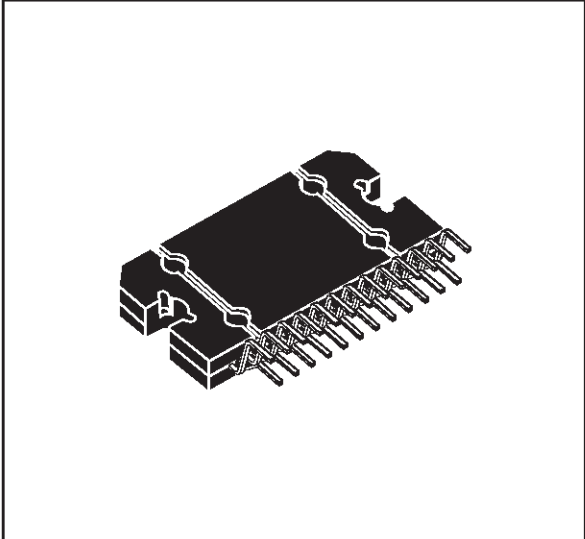

Flexiwatt25

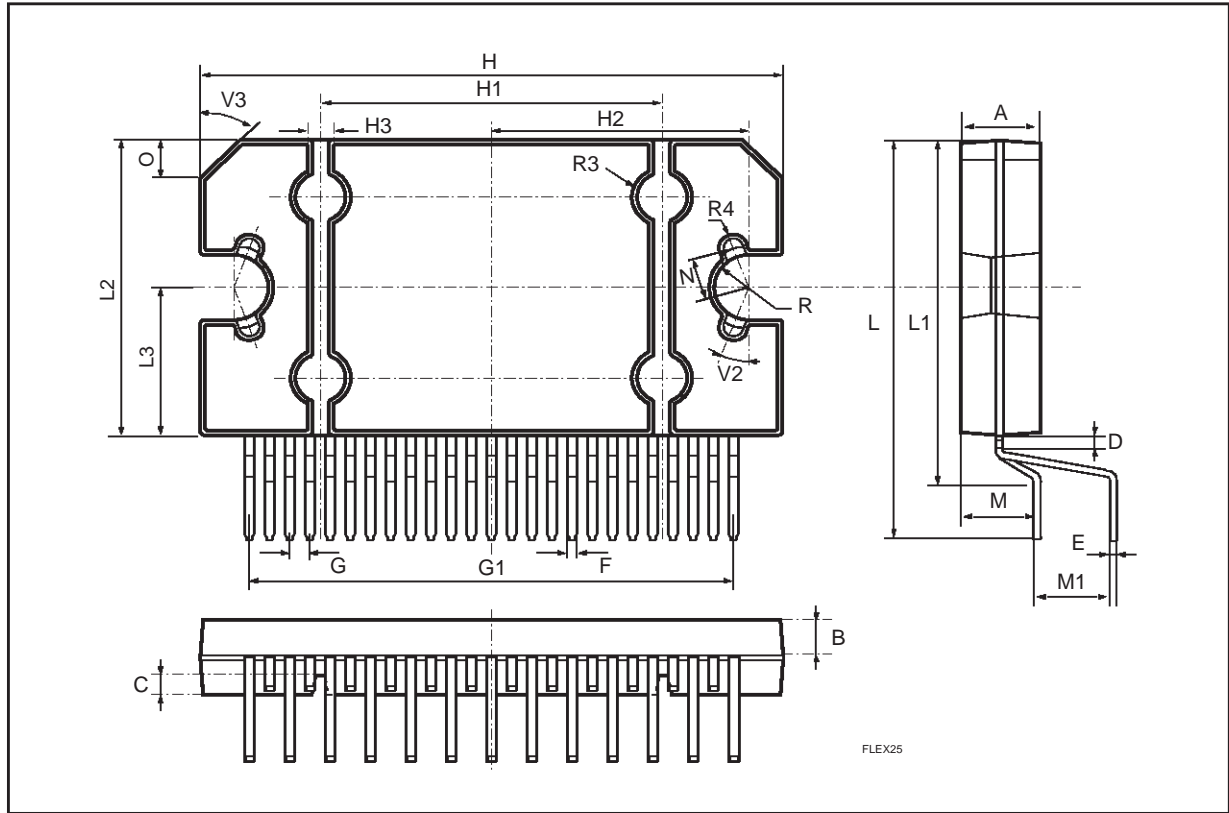

Information furnished is believed to be accurate and reliable. However, STMicroelectronics assumes no responsibility for the consequences of use of such information nor for any infringement of patents or other rights of third parties which may result from its use. No license is granted by implication or otherwise under any patent or patent rights of STMicroelectronics. Specification mentioned in this publication are subject to change without notice. This publication supersedes and replaces all information previously supplied. STMicroelectronics products are not authorized for use as critical components in life support devices or systems without express written approval of STMicroelectronics.

The ST logo is a registered trademark of STMicroelectronics

© 1999 STMicroelectronics – Printed in Italy – All Rights Reserved

STMicroelectronics GROUP OF COMPANIES

Australia - Brazil - Canada - China - France - Germany - Italy - Japan - Korea - Malaysia - Malta - Mexico - Morocco - The Netherlands - Singapore - Spain - Sweden - Switzerland - Taiwan - Thailand - United Kingdom - U.S.A.

<http://www.st.com>