

DBL 1010/2

DUAL PREAMPLIFIER

FEATURES

- High voltage gain: $G_{VO} = 100\text{dB}$ (Typ.) at $f = 1\text{kHz}$
- Excellent channel separation and high ripple rejection: $CH_{SEP.} = 70\text{dB}$ (Typ.)
 $R.R. = 50\text{dB}$ (Typ.)
- Low noise: $V_{NI} = 1.0\mu\text{Vrms}$ (Typ.)
at $R_g = 2.2\text{k}\Omega$, $BW = 15\text{Hz} \sim 30\text{kHz}$
- Muting circuit built-in: $2V \geq V_o \geq 0.9V$
- Wide operating supply voltage range: $V_{CC} = 7 \sim 18V$.

APPLICATIONS

- Car or home stereo use.

* DBL 1010 is 8 SIP, Pin9(function : Muting) cut.

MAXIMUM RATINGS (Ta=25°C)

Characteristic	Symbol	Rating	Unit
Supply Voltage	V_{CC}	18	V
Power Dissipation(*)	P_D	700	mW
Operating Temperature	T_{opr}	-25 ~ +75	°C
Storage Temperature	T_{stg}	-55 ~ +150	°C

* Derated above $T_a = 25^\circ\text{C}$ in the proportion of $5.6\text{mW}/^\circ\text{C}$

ELECTRICAL CHARACTERISTICS

(Unless otherwise specified, $V_{CC} = 10V$, $f = 1\text{kHz}$, $R_g = 600\Omega$, $R_L = 10\text{k}\Omega$, $T_a = 25^\circ\text{C}$)

Characteristic	Symbol	Test Circuit	Test Condition	Min.	Typ.	Max.	Unit
Quiescent Current	I_{CCO}	1	—	—	5.5	8.5	mA
Open Loop Voltage Gain	G_{VO}	1	$C_f = 100\mu\text{F}$, $R_f = 0$	—	100	—	dB
Maximum Output Voltage	V_{OM}	2	THD = 0.5%, NAB EQ	2	2.8	—	Vrms
Equivalent Input Noise Voltage	V_{NI}	2	$R_g = 2.2\text{k}\Omega$ BPF = 15Hz ~ 30kHz	—	1	2.5	μVrms
Input Resistance	R_{IN}	2	$V_o = 1\text{Vrms}$	—	100	—	k Ω
Channel Separation	CH_{SEP}	2	$f = 10\text{kHz}$, $R_g = 2.2\text{k}\Omega$ $V_o = 1\text{Vrms}$	—	70	—	dB
Ripple Rejection	R.R.	2	$f = 100\text{Hz}$, $V_{IN} = 1\text{Vrms}$ CB = NO connection	—	50	—	dB
Muting Ratio	M.R.	2	$V_o = 1V$, $OdB = 1\text{Vrms}$	—	80	—	dB

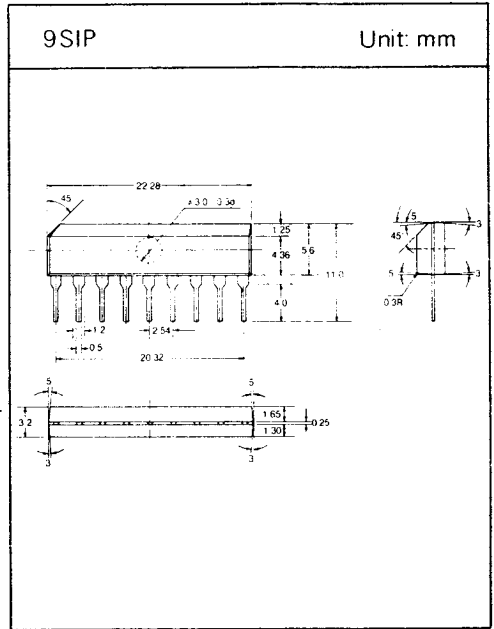

DBL 1010/2

□ BLOCK DIAGRAM

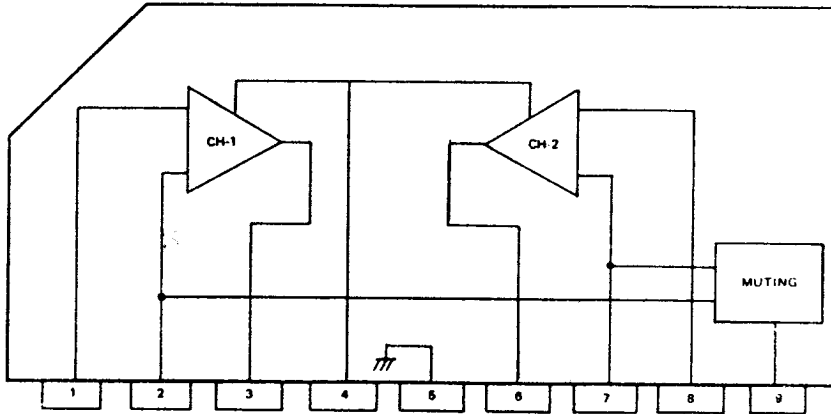

1. Input (+)
2. Input (-)
3. Output
4. Power Supply
5. Ground
6. Output
7. Input (-)
8. Input (+)
9. Muting

□ TEST CIRCUIT

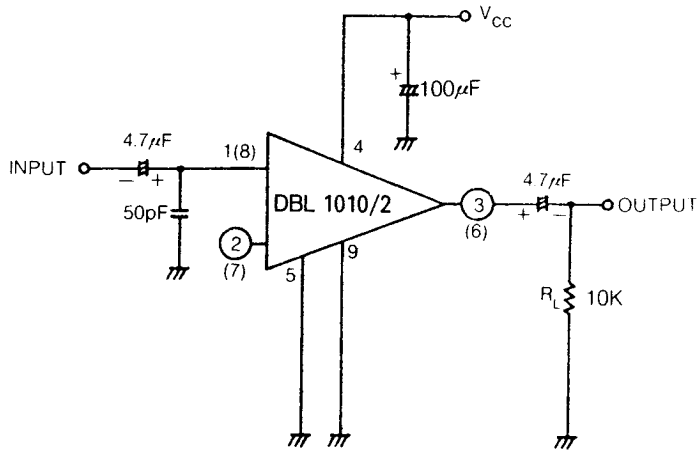

1. G_{VO} , I_{CC}

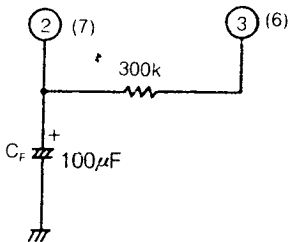

2. V_{OM} , V_{NI} , R_{NI} , R_R

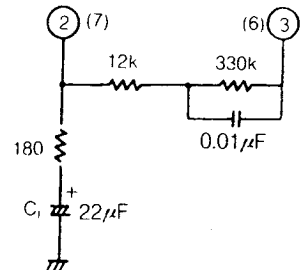

DBL 1010/2

APPLICATION

1. Decision of Feedback Resistance

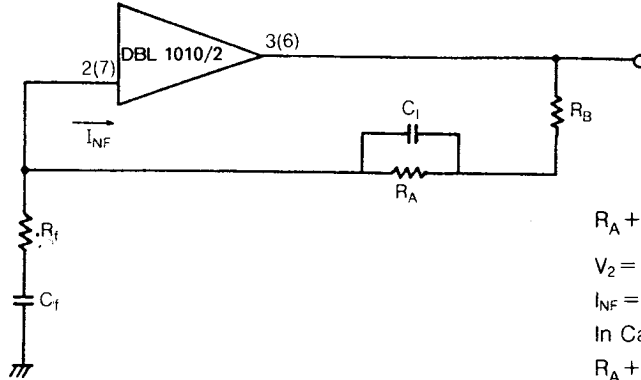

2. EQ Amplifier

○ Main Circuit

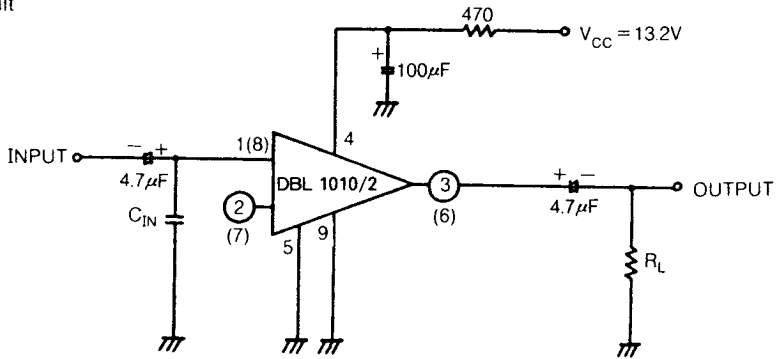

○ Feedback Circuits

1) RIAA EQ

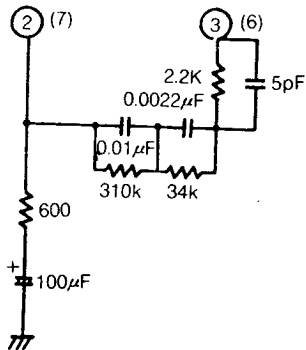

2) NAB EQ

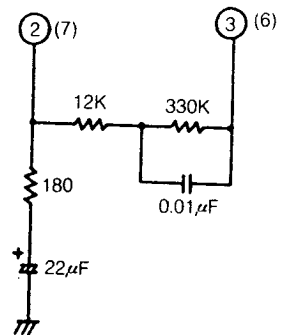

DBL 1010/2

3. MUTING CIRCUIT APPLICATION

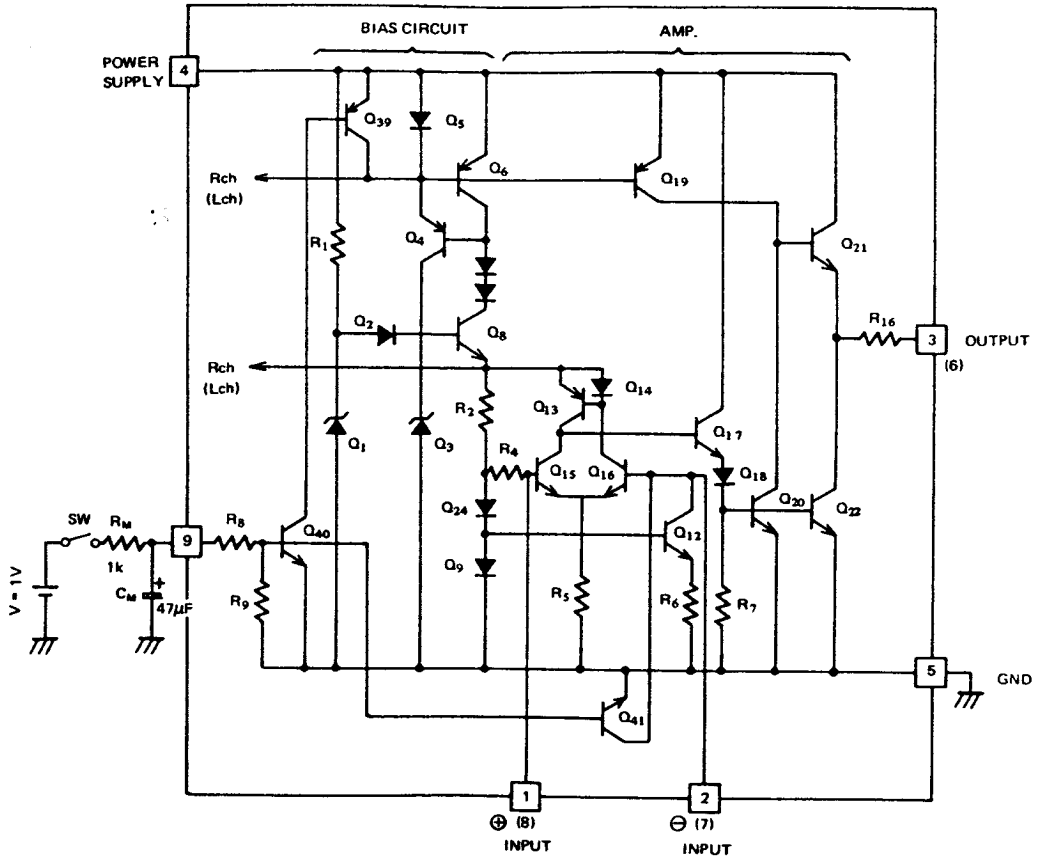

- The Q40 is turned ON when the voltage above 0.9V feed into PIN 9, Q41 and Q39 'turned ON' consequently and the muting operating obtained.

4. NOTE

- Care should be taken not to decrease a closed loop gain less 20dB cause parasitic oscillation.
- The maximum allowable input voltage is 300 mVrms not to increase the input voltage above this value for stable operation.

□ TYPICAL PERFORMANCE CHARACTERISTICS

$V_{CC} - R_{NF}$

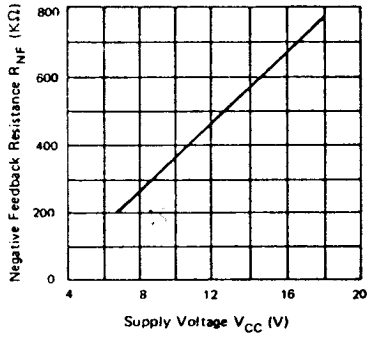

$R_g - V_{NI}$

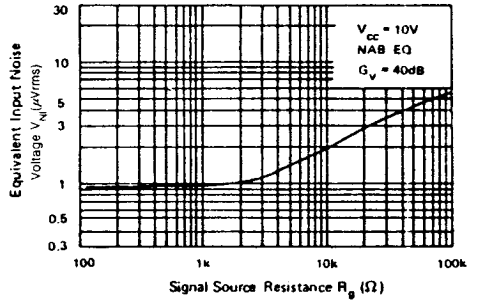

$V_{OUT} - THD$

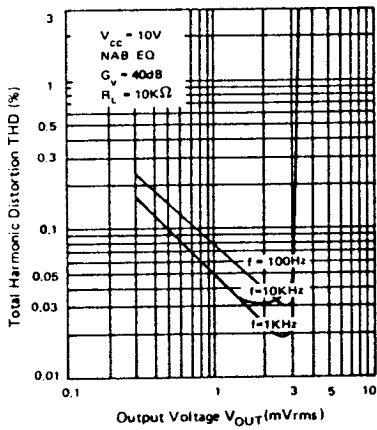

$V_{OUT} - THD$

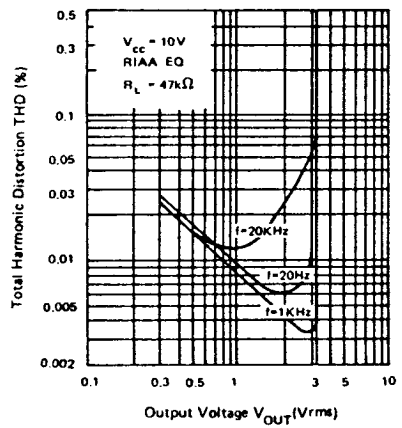

$V_{IN} - V_{OUT}$

