

No.2294A

LC7821, 7822, 7823

Analog Function Switch

Use

- . Serial data-controlled function select switch suited for use in amplifiers, receivers.

Features

- . Analog switches of 8 channels x 2 (LC7823: 7 channels x 2) are contained. Three types are available according to the internal connection.
- . Control is exercised by serial data. The LC7821,7822,7823 may be interfaced with a microcomputer (5V-operated) easily.
- . Even if two ICs of the same type are used, they may be connected to the common bus line because the S (selector) pin is provided.
- . Reset pin used to turn OFF all analog switches
- . Wide dynamic range because of $\pm 20V$ breakdown voltage

Absolute Maximum Ratings at Ta=25°C

				unit
Maximum Supply Voltage	V_{DDmax}	V_{DD}	-0.3 to +20	V
	V_{EEmax}	V_{EE}	-20 to +0.3	V
Maximum Input Voltage	V_{I1}	DI, CL, CE, S, RES	-0.3 to +20	V
	V_{I2}	L1toL8, R1toR8, $V_{EE}-0.3toV_{DD}+0.3$ LCOM1 to LCOM4, RCOM1 to RCOM4		V
Analog Switch ON-State Voltage Difference	ΔV_{ON}	Switch ON	0.5	V
Allowable Power Dissipation	P_{dmax}	$T_a \leq 75^\circ C$	100	mW
Operating Temperature	T_{opr}		-30 to +75	°C
Storage Temperature	T_{stg}		-40 to +125	°C

Pin Assignment

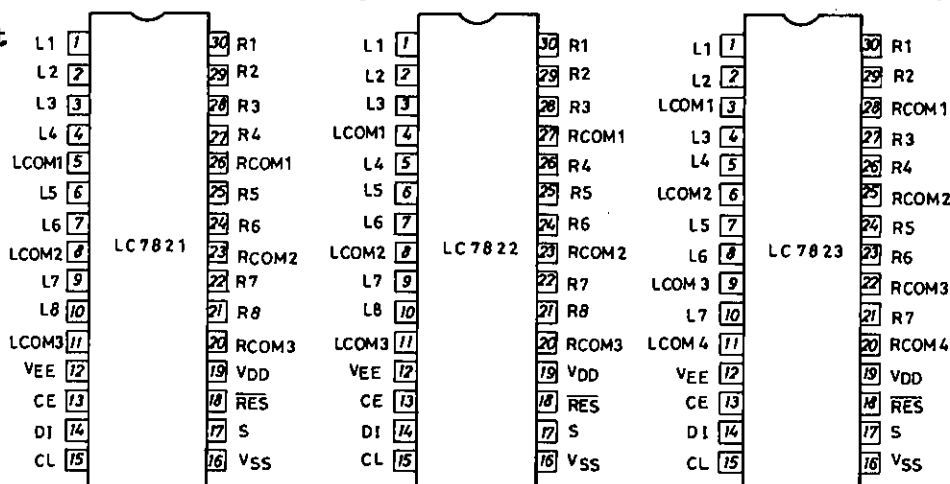

Package Dimensions 3047A
(unit: mm)

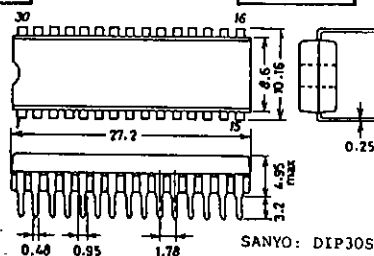

Allowable Operating Conditions at Ta=25°C, V _{SS} =0V, V _{DD} ≥ V _{EE}		min	typ	max	unit
Maximum Supply Voltage	V _{DD}	V _{DD} -V _{EE} ≥ 12V: V _{DD}	6.0	18.5	V
	V _{EE}	V _{DD} -V _{EE} ≥ 12V: V _{EE}	-18.5	0	V
Input "H"-Level Voltage	V _{IH1}	DI, CL, CE	4.0	18.5	V
	V _{IH2}	S, RES	0.7V _{DD}	V _{DD}	V
Input "L"-Level Voltage	V _{IL1}	DI, CL, CE	0	0.7	V
	V _{IL2}	S, RES	0	0.3V _{DD}	V
Analog Switch Input Voltage Range	V _{IN}	L1toL8, R1toR8, LCOM1toLCOM4, RCOM1toRCOM4	V _{EE}	V _{DD}	V
"L"-Level Clock Pulse Width	t _{OL}	C _L	0.5		μs
"H"-Level Clock Pulse Width	t _{OH}	C _L	0.5		μs
Setup Time	t _{setup}	CL, DI	0.5		μs
	t _{1*}	CL, CE	0.5		μs
	t _{2*}	CL, CE	0.5		μs
	t _{3*}	CL, CE	0.5		μs
Reset Minimum Pulse Width	t _{wRES}	V _{DD} ≥ 6V: RES	1.0		μs
Hysteresis Width	V _H	CL, CE, DI	0.3		V

*: CE, CL, DI waveforms

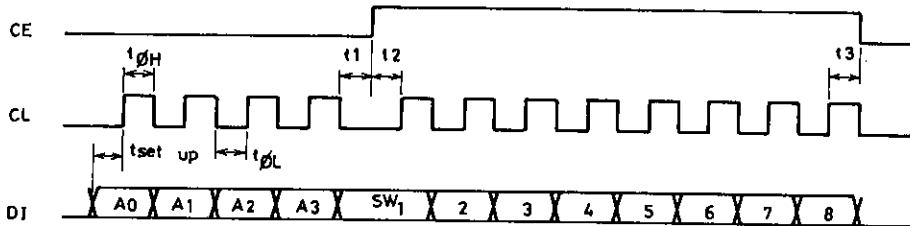

Electrical Characteristics at Ta=25°C, V _{SS} =0V		min	typ	max	unit
Analog Switch ON-State Resistance	R _{ON1}	I=1mA, V _{DD} -V _{EE} =12V: L1toL8, R1toR8, LCOM1toLCOM4, RCOM1toRCOM4		150	ohm
	R _{ON2}	I=1mA, V _{DD} -V _{EE} =37V: L1toL8, R1toR8, LCOM1toLCOM4, RCOM1toRCOM4		70	ohm
Total Harmonic Distortion	THD1	V _{IN} =1Vrms, f=1kHz, V _{DD} -V _{EE} =37V: L1toL8, R1toR8, LCOM1toLCOM4, RCOM1toRCOM4	0.0015	0.01	%
	THD2	V _{IN} =0.1Vrms, f=1kHz, V _{DD} -V _{EE} =37V: L1toL8, R1toR8, LCOM1toLCOM4, RCOM1toRCOM4	0.01	0.05	%
Feedthrough	F _{TH}	V _{IN} =0dBV, f=10kHz, V _{DD} -V _{EE} =37V, L1toL8, R1toR8, LCOM1toLCOM4, RCOM1toRCOM4		55	dB
Crosstalk	CT	V _{IN} =0dBV, f=10kHz, V _{DD} -V _{EE} =37V: L1toL8, R1toR8, LCOM1toLCOM4, RCOM1toRCOM4		75	dB
Input "H"-Level Current	I _{IH}	V _I =18.5V: DI, CL, CE, S, RES		10	μA
Input "L"-Level Current	I _{IL}	V _I =0V: DI, CL, CE, S, RES	-10		μA
Analog Switch OFF-State Leakage Current	I _{OFF}	V _I =V _{EE} to V _{EE} +37V: L1toL8, R1toR8, LCOM1toLCOM4, RCOM1toRCOM4	-10	10	μA
Current Dissipation	I _{DD}	V _{DD}		1.0	mA

Equivalent Circuit Block Diagram

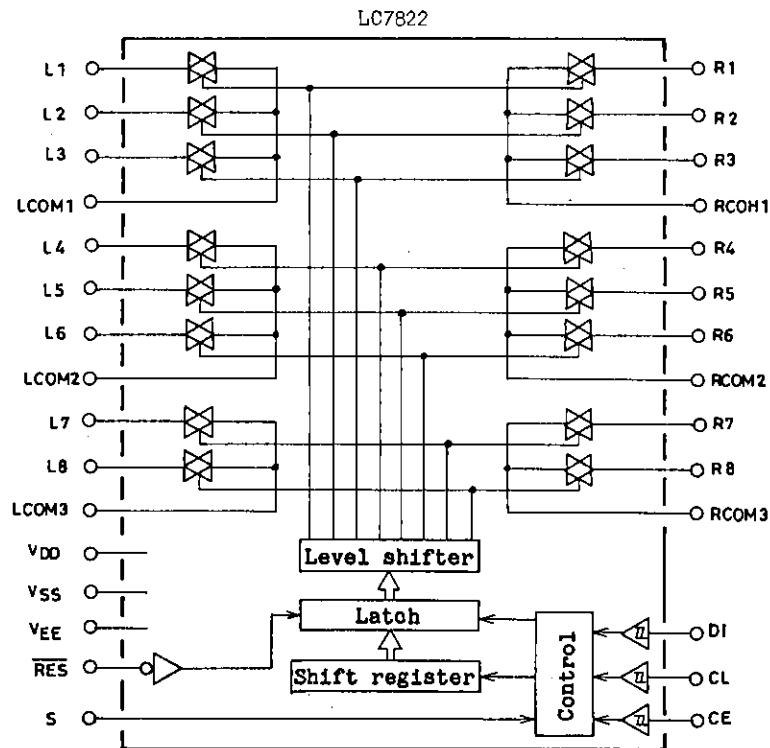
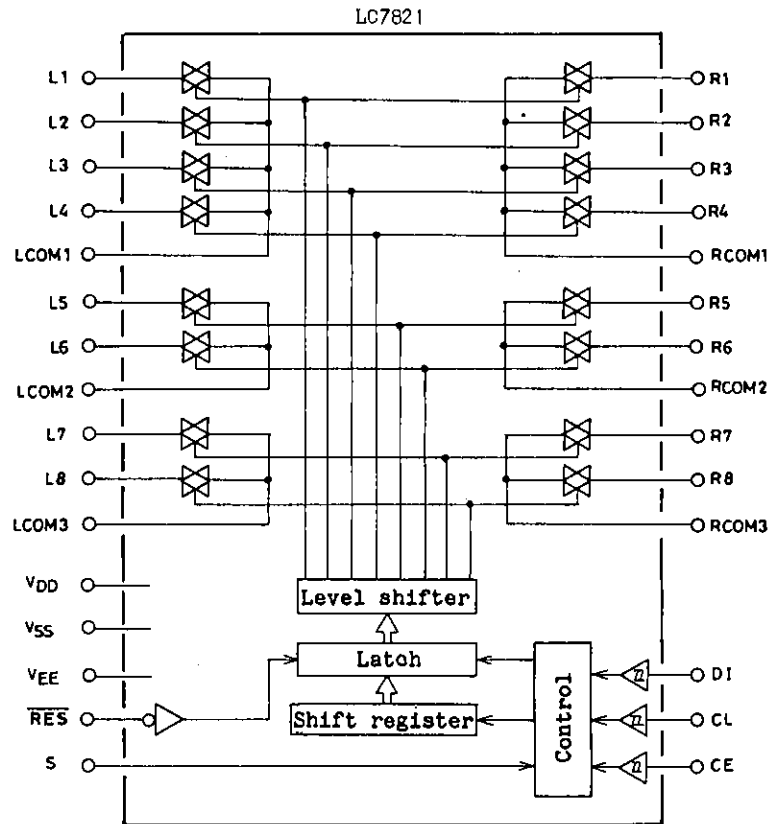

Equivalent Circuit Block Diagram

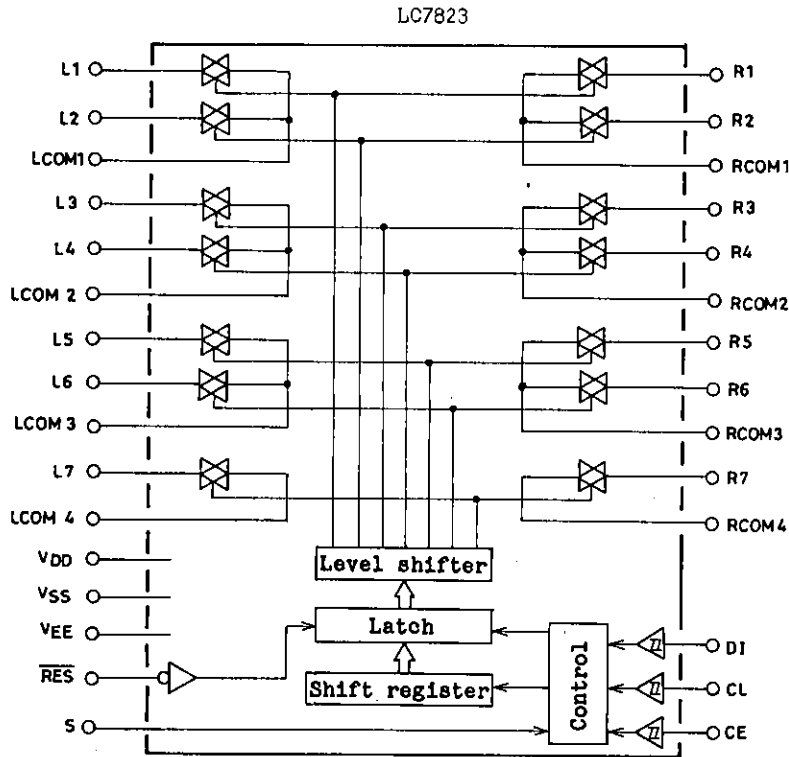

Pin Description

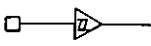
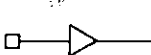
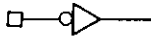
Pin Name	I/O	Internal Equivalent Circuit	Function																																											
VDD, VSS, VEE			Power supply pins																																											
L1 to L8, R1 to R8, LCOM1 to LCOM4, RCOM1 to RCOM4		See Block Diagram.	Input/output pins for analog switches.																																											
CL, DI, CE	I		Serial data input pins (Schmitt buffer) CL --- Clock input pin DI --- Data input pin CE --- Chip enable pin																																											
S	I		Select pin in the two ICs-used mode When the S pin is brought to "L" or "H" level, the addresses will become as shown below. <table border="1" data-bbox="1005 1624 1412 1859"> <thead> <tr> <th rowspan="2">Type No.</th> <th rowspan="2">S Pin</th> <th colspan="4">Address</th> </tr> <tr> <th>A₀</th> <th>A₁</th> <th>A₂</th> <th>A₃</th> </tr> </thead> <tbody> <tr> <td rowspan="2">LC7821</td> <td>L</td> <td>0</td> <td>1</td> <td>0</td> <td>1</td> </tr> <tr> <td>H</td> <td>1</td> <td>1</td> <td>0</td> <td>1</td> </tr> <tr> <td rowspan="2">LC7822</td> <td>L</td> <td>0</td> <td>0</td> <td>1</td> <td>1</td> </tr> <tr> <td>H</td> <td>1</td> <td>0</td> <td>1</td> <td>1</td> </tr> <tr> <td rowspan="2">LC7823</td> <td>L</td> <td>0</td> <td>1</td> <td>1</td> <td>1</td> </tr> <tr> <td>H</td> <td>1</td> <td>1</td> <td>1</td> <td>1</td> </tr> </tbody> </table>	Type No.	S Pin	Address				A ₀	A ₁	A ₂	A ₃	LC7821	L	0	1	0	1	H	1	1	0	1	LC7822	L	0	0	1	1	H	1	0	1	1	LC7823	L	0	1	1	1	H	1	1	1	1
Type No.	S Pin	Address																																												
		A ₀	A ₁	A ₂	A ₃																																									
LC7821	L	0	1	0	1																																									
	H	1	1	0	1																																									
LC7822	L	0	0	1	1																																									
	H	1	0	1	1																																									
LC7823	L	0	1	1	1																																									
	H	1	1	1	1																																									
RES	I		Reset pin When power is applied, the state of the analog switches will be indeterminate. When this pin is brought to "L" level, all analog switches will be turned OFF.																																											

Operation Description

1. Data input method

The LC7821, 7822, 7823 are controlled by inputting serial data to the CL, DI, CE pins. Data consists of 12 bits in all (address: 4 bits, data: 8 bits).

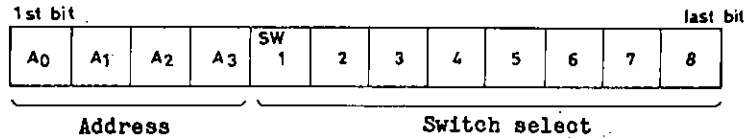

Each switch No. corresponds to analog switches L1 to L8, R1 to R8. Set the bit of a switch to be turned ON to 1.

- 0 ----- OFF
- 1 ----- ON

The address is used for chip select when connected to the common bus line. When the S pin is brought to "L" or "H" level, the transmit data will become as shown below.

Type No.	S Pin	Address			
		A0	A1	A2	A3
LC7821	L	0	1	0	1
	H	1	1	0	1
LC7822	L	0	0	1	1
	H	1	0	1	1
LC7823	L	0	1	1	1
	H	1	1	1	1

Note: For the LC7823, the bit of switch 8 becomes "don't care" (0 or 1). The reason for this is that the LC7823 contains 7 channels x 2 of analog switches.

2. Timing of DI, CL, CE pulse signals

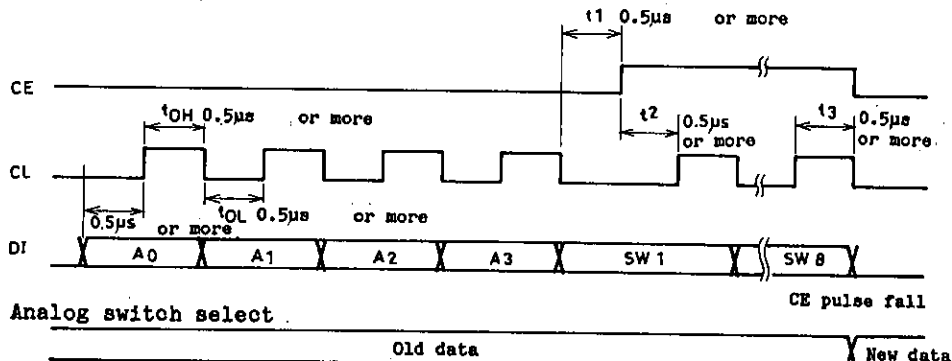

Data is fetched into the inside on the positive transition of the CL pulse and latched on the negative transition of the CE pulse.

3. Reset pin

When power is applied, the state of the analog switches will be indeterminate. All analog switches may be turned OFF by connecting C, R to this pin externally.

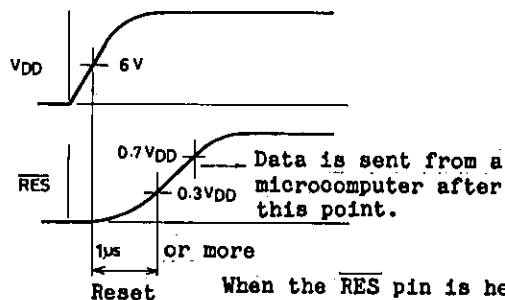
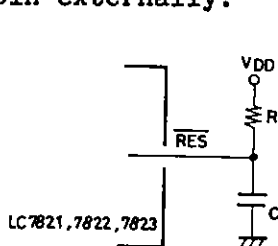

When the RES pin is held at "L" level for 1µsec. or more, all analog switches will be turned OFF.