

### FEATURES

- Conversion Time: 800 ns**
- 1.25 MHz Throughput Rate**
- Complete: On-Chip Sample-and-Hold Amplifier and Voltage Reference**
- Low Power Dissipation: 570 mW**
- No Missing Codes Guaranteed**
- Signal-to-Noise Plus Distortion Ratio**  
 $f_{IN} = 100 \text{ kHz: } 70 \text{ dB}$
- Pin Configurable Input Voltage Ranges**
- Twos Complement or Offset Binary Output Data**
- 28-Pin DIP and 28-Pin Surface Mount Package**
- Out of Range Indicator**

### PRODUCT DESCRIPTION

The AD1671 is a monolithic 12-bit, 1.25 MSPS analog-to-digital converter with an on-board, high performance sample-and-hold amplifier (SHA) and voltage reference. The AD1671 guarantees no missing codes over the full operating temperature range. The combination of a merged high speed bipolar/CMOS process and a novel architecture results in a combination of speed and power consumption far superior to previously available hybrid implementations. Additionally, the greater reliability of monolithic construction offers improved system reliability and lower costs than hybrid designs.

The fast settling input SHA is equally suited for both multiplexed systems that switch negative to positive full-scale voltage levels in successive channels and sampling inputs at frequencies up to and beyond the Nyquist rate. The AD1671 provides both reference output and reference input pins, allowing the on-board reference to serve as a system reference. An external reference can also be chosen to suit the dc accuracy and temperature drift requirements of the application.

The AD1671 uses a subranging flash conversion technique, with digital error correction for possible errors introduced in the first part of the conversion cycle. An on-chip timing generator provides strobe pulses for each of the four internal flash cycles. A single ENCODE pulse is used to control the converter. The digital output data is presented in twos complement or offset binary output format. An out-of-range signal indicates an overflow condition. It can be used with the most significant bit to determine low or high overflow.

### REV. B

Information furnished by Analog Devices is believed to be accurate and reliable. However, no responsibility is assumed by Analog Devices for its use, nor for any infringements of patents or other rights of third parties which may result from its use. No license is granted by implication or otherwise under any patent or patent rights of Analog Devices.

### FUNCTIONAL BLOCK DIAGRAM

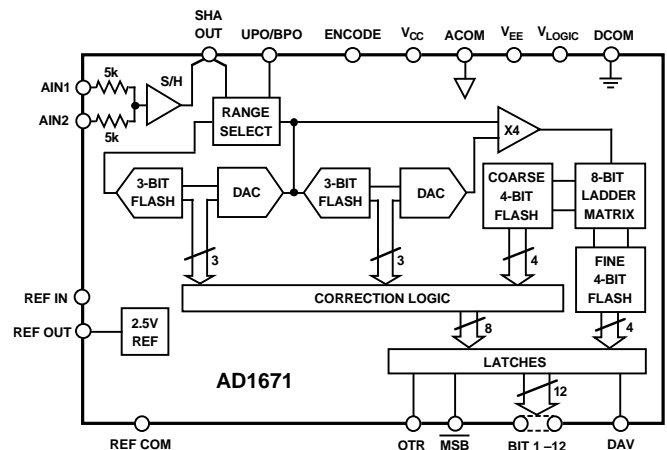

The performance of the AD1671 is made possible by using high speed, low noise bipolar circuitry in the linear sections and low power CMOS for the logic sections. Analog Devices' ABCMOS-1 process provides both high speed bipolar and 2-micron CMOS devices on a single chip. Laser trimmed thin-film resistors are used to provide accuracy and temperature stability.

The AD1671 is available in two performance grades and three temperature ranges. The AD1671J and K grades are available over the 0°C to +70°C temperature range. The AD1671A grade is available over the -40°C to +85°C temperature range. The AD1671S grade is available over the -55°C to +125°C temperature range.

### PRODUCT HIGHLIGHTS

The AD1671 offers a complete single chip sampling 12-bit, 1.25 MSPS analog-to-digital conversion function in a 28-pin package.

The AD1671 at 570 mW consumes a fraction of the power of currently available hybrids.

An OUT OF RANGE output bit indicates when the input signal is beyond the AD1671's input range.

Input signal ranges are 0 V to +5 V unipolar or  $\pm 5$  V bipolar, selected by pin strapping, with an input resistance of 10 k $\Omega$ . The input signal range can also be pin strapped for 0 V to +2.5 V unipolar or  $\pm 2.5$  V bipolar with an input resistance of 10 M $\Omega$ .

Output data is available in unipolar, bipolar offset or bipolar twos complement binary format.

# AD1671—SPECIFICATIONS

## DC SPECIFICATIONS (T<sub>MIN</sub> to T<sub>MAX</sub> with V<sub>CC</sub> = +5 V ± 5%, V<sub>LOGIC</sub> = +5 V ± 10%, V<sub>EE</sub> = -5 V ± 5%, unless otherwise noted)

Parameter	AD1671J/A/S			AD1671K			Units
	Min	Typ	Max	Min	Typ	Max	
RESOLUTION	12			12			Bits
CONVERSION TIME			800			800	ns
ACCURACY							
Integral Nonlinearity (INL) (S Grade)		±1.5	±2.5 ±3.0		±0.7	±2.5	LSB
Differential Nonlinearity (DNL) No Missing Codes	11 11 Bits Guaranteed			12 12 Bits Guaranteed			Bits
Unipolar Offsets <sup>1</sup> (+25°C)			±9			±9	LSB
Bipolar Zero <sup>1</sup> (+25°C)			±10			±10	LSB
Gain Error <sup>1,2</sup> (+25°C)		0.1	0.35		0.1	0.35	% FSR
TEMPERATURE COEFFICIENTS <sup>3</sup>							
Unipolar Offset (S Grade)			±25 ±25			±25	ppm/°C
Bipolar Zero (S Grade)			±25 ±30			±25	ppm/°C
Gain Error <sup>3</sup> (S Grade)			±30 ±40			±30	ppm/°C
Gain Error <sup>4</sup>			±20			±20	ppm/°C
POWER SUPPLY REJECTION <sup>5</sup>							
V <sub>CC</sub> (+5 V ± 0.25 V) (S Grade)			±4 ±5			±4	LSB
V <sub>LOGIC</sub> (+5 V ± 0.25 V) (S Grade)			±4 ±5			±4	LSB
V <sub>EE</sub> (-5 V ± 0.25 V) (S Grade)			±4 ±5			±4	LSB
ANALOG INPUT							
Input Ranges							
Bipolar	-2.5 -5.0		+2.5 +5.0	-2.5 -5.0		+2.5 +5.0	Volts Volts
Unipolar	0 0		+2.5 +5.0	0 0		+2.5 +5.0	Volts Volts
Input Resistance (0 V to +2.5 V or ±2.5 V Range) (0 V to +5.0 V or ±5 V Range)		10 10			10 10		MΩ kΩ
Input Capacitance		10			10		pF
Aperture Delay		15			15		ns
Aperture Jitter		20			20		ps
INTERNAL VOLTAGE REFERENCE							
Output Voltage	2.475	2.5	2.525	2.475	2.5	2.525	Volts
Output Current							
Unipolar Mode			+2.5			+2.5	mA
Bipolar Mode			+1.0			+1.0	mA
LOGIC INPUTS							
High Level Input Voltage, V <sub>IH</sub>	2.0			2.0			Volts
Low Level Input Voltage, V <sub>IL</sub>			0.8			0.8	Volts
High Level Input Current, I <sub>IH</sub> (V <sub>IN</sub> = V <sub>LOGIC</sub> )	-10		+10	-10		+10	μA
Low Level Input Current, I <sub>IL</sub> (V <sub>IN</sub> = 0 V)	-10		+10	-10		+10	μA
Input Capacitance, C <sub>IN</sub>		5			5		pF
LOGIC OUTPUTS							
High Level Output Voltage, V <sub>OH</sub> (I <sub>OH</sub> = 0.5 mA)	2.4			2.4			Volts
Low Level Output Voltage, V <sub>OL</sub> (I <sub>OL</sub> = 1.6 mA)			0.4			0.4	Volts
POWER SUPPLIES							
Operating Voltages							
V <sub>CC</sub>	+4.75		+5.25	+4.75		+5.25	Volts
V <sub>LOGIC</sub>	+4.5		+5.5	+4.5		+5.5	Volts
V <sub>EE</sub>	-4.75		-5.25	-4.75		-5.25	Volts
Operating Current							
I <sub>CC</sub>		55	68		55	68	mA
I <sub>LOGIC</sub> <sup>6</sup>		3	5		3	5	mA
I <sub>EE</sub>		-55	-68		-55	-68	mA
POWER CONSUMPTION		570	750		570	750	mW
TEMPERATURE RANGE (SPECIFIED)							
J/K	0		+70	0		+70	°C
A	-40		+85	-40		+85	°C
S	-55		+125	-55		+125	°C

### NOTES

<sup>1</sup>Adjustable to zero with external potentiometers.

<sup>2</sup>Includes internal voltage reference error.

<sup>3</sup>+25°C to T<sub>MIN</sub> and +25°C to T<sub>MAX</sub>

<sup>4</sup>Excludes internal reference drift.

<sup>5</sup>Change in gain error as a function of the dc supply voltage.

<sup>6</sup>Tested under static conditions. See Figure 15 for typical curve of I<sub>LOGIC</sub> vs. load capacitance at maximum t<sub>c</sub>.

Specifications subject to change without notice.

## AC SPECIFICATIONS ( $T_{MIN}$ to $T_{MAX}$ with $V_{CC} = +5 V \pm 5\%$ , $V_{LOGIC} = +5 V \pm 10\%$ , $V_{EE} = -5 V \pm 5\%$ , $f_{SAMPLE} = 1$ MSPS, $f_{INPUT} = 100$ kHz, unless otherwise noted)<sup>1</sup>

Parameter	AD1671J/A/S			AD1671K			Units
	Min	Typ	Max	Min	Typ	Max	
SIGNAL-TO-NOISE PLUS DISTORTION RATIO (S/N + D) -0.5 dB Input -20 dB Input	68	70		68	71		dB
		50			51		dB
EFFECTIVE NUMBER OF BITS (ENOB)	11.2			11.2			Bits
TOTAL HARMONIC DISTORTION (THD)		-80	-75		-83	-75	dB
PEAK SPURIOUS OR PEAK HARMONIC COMPONENT		-80	-77		-81	-77	dB
SMALL SIGNAL BANDWIDTH		12			12		MHz
FULL POWER BANDWIDTH		2			2		MHz
INTERMODULATION DISTORTION (IMD) <sup>2</sup> 2nd Order Products 3rd Order Products		-80	-75		-80	-75	dB
		-85	-75		-85	-75	dB

## NOTES

<sup>1</sup> $f_{IN}$  amplitude = -0.5 dB (9.44 V p-p) bipolar mode full scale unless otherwise indicated. All measurements referred to a 0 dB ( $\pm 5$  V) input signal, unless otherwise indicated.

<sup>2</sup> $f_A = 99$  kHz,  $f_B = 100$  kHz with  $f_{SAMPLE} = 1$  MSPS.

Specifications subject to change without notice.

## SWITCHING SPECIFICATIONS (For all grades $T_{MIN}$ to $T_{MAX}$ with $V_{CC} = +5 V \pm 5\%$ , $V_{LOGIC} = +5 V \pm 10\%$ , $V_{EE} = -5 V \pm 5\%$ ; $V_{IL} = 0.8$ V, $V_{IH} = 2.0$ V, $V_{OL} = 0.4$ V and $V_{OH} = 2.4$ V)

Parameters	Symbol	Min	Typ	Max	Units
Conversion Time	$t_C$			800	ns
Sample Rate	$F_S$			1.25	MSPS
ENCODE Pulse Width High (Figure 1a)	$t_{ENC}$	20		50	ns
ENCODE Pulse Width Low (Figure 1b)	$t_{ENCL}$	20			ns
DAV Pulse Width	$t_{DAV}$	150		300	ns
ENCODE Falling Edge Delay	$t_F$	0			ns
Start New Conversion Delay	$t_R$	0			ns
Data and OTR Delay from DAV Falling Edge	$t_{DD}^1$	20	75		ns
Data and OTR Valid before DAV Rising Edge	$t_{SS}^2$	20	75		ns

## NOTES

<sup>1</sup> $t_{DD}$  is measured from when the falling edge of DAV crosses 0.8 V to when the output crosses 0.4 V or 2.4 V with a 25 pF load capacitor on each output pin.

<sup>2</sup> $t_{SS}$  is measured from when the outputs cross 0.4 V or 2.4 V to when the rising edge of DAV crosses 2.4 V with a 25 pF load capacitor on each output pin.

Specifications subject to change without notice.

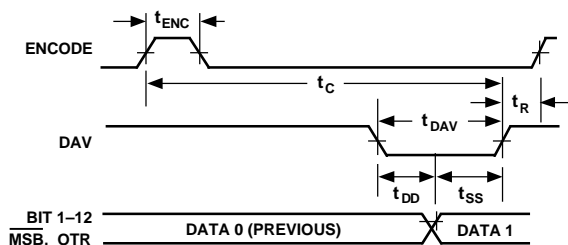

Figure 1a. Encode Pulse HIGH

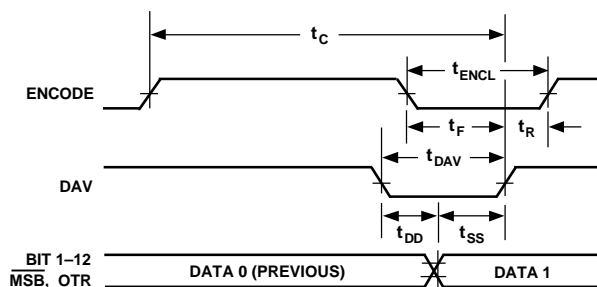

Figure 1b. Encode Pulse LOW

# AD1671

## PIN DESCRIPTION

Symbol	Pin No.	Type	Name and Function									
ACOM	27	P	Analog Ground.									
AIN	22, 23	AI	Analog Inputs, AIN1 and AIN2. The AD1671 can be pin strapped for four input ranges: <table border="0" style="margin-left: 20px;"> <tr> <td>Range</td> <td>Pin Strap</td> <td>Signal Input</td> </tr> <tr> <td>0 to +2.5 V, <math>\pm 2.5</math> V</td> <td>Connect AIN1 to AIN2</td> <td>AIN1 or AIN2</td> </tr> <tr> <td>0 to +5 V, <math>\pm 5</math> V</td> <td>Connect AIN1 or AIN2 to ACOM</td> <td>AIN1 or AIN2</td> </tr> </table>	Range	Pin Strap	Signal Input	0 to +2.5 V, $\pm 2.5$ V	Connect AIN1 to AIN2	AIN1 or AIN2	0 to +5 V, $\pm 5$ V	Connect AIN1 or AIN2 to ACOM	AIN1 or AIN2
Range	Pin Strap	Signal Input										
0 to +2.5 V, $\pm 2.5$ V	Connect AIN1 to AIN2	AIN1 or AIN2										
0 to +5 V, $\pm 5$ V	Connect AIN1 or AIN2 to ACOM	AIN1 or AIN2										
BIT 1 (MSB)	13	DO	Most Significant Bit.									
BIT 2–BIT 11	12–3	DO	Data Bits 2 through 11.									
BIT 12 (LSB)	2	DO	Least Significant Bit.									
BPO/UPO	26	AI	Bipolar or Unipolar Configuration Pin. See section on Input Range Connections for details.									
DAV	16	DO	Data Available Output. The rising edge of DAV indicates an end of conversion and can be used to latch current data into an external register. The falling edge of DAV can be used to latch previous data into an external register.									
DCOM	19	P	Digital Ground.									
ENCODE	17	DI	The analog input is sampled on the rising edge of ENCODE.									
$\overline{\text{MSB}}$	14	DO	Inverted Most Significant Bit. Provides twos complement output data format.									
OTR	15	DO	Out of Range is Active HIGH when the analog input is out of range. See Output Data Format, Table III.									
REF COM	20	AI	REF COM is the internal reference ground pin. REF COM should be connected as indicated in the Grounding and Decoupling Rules and Optional External Reference Connection Sections.									
REF IN	24	AI	REF IN is the external 2.5 V reference input.									
REF OUT	21	AO	REF OUT is the internal 2.5 V reference output.									
SHA OUT	25	AO	No Connect for bipolar input ranges. Connect SHA OUT to BPO/UPO for unipolar input ranges.									
V <sub>CC</sub>	28	P	+5 V Analog Power.									
V <sub>EE</sub>	1	P	–5 V Analog Power.									
V <sub>LOGIC</sub>	18	P	+5 V Digital Power.									

TYPE: AI = Analog Input; AO = Analog Output; DI = Digital Input; DO = Digital Outputs; P = Power.

## PIN CONFIGURATION

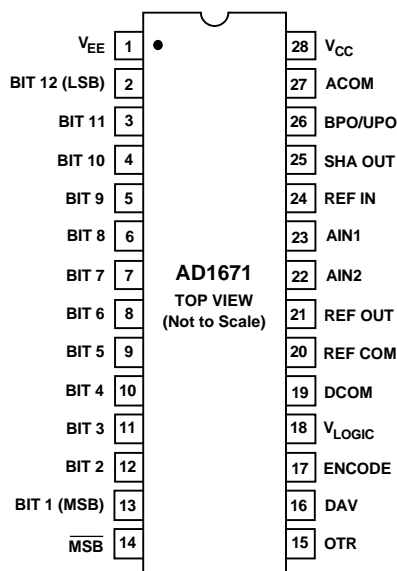

## ABSOLUTE MAXIMUM RATINGS\*

Parameter	With Respect to	Min	Max	Units
V <sub>CC</sub>	ACOM	-0.5	+6.5	Volts
V <sub>EE</sub>	ACOM	-6.5	+0.5	Volts
V <sub>LOGIC</sub>	DCOM	-0.5	+6.5	Volts
ACOM	DCOM	-1.0	+1.0	Volts
V <sub>CC</sub>	V <sub>LOGIC</sub>	-6.5	+6.5	Volts
ENCODE	DCOM	-0.5	V <sub>LOGIC</sub> + 0.5	Volts
REF IN	ACOM	-0.5	V <sub>CC</sub> + 0.5	Volts
AIN	ACOM	-11.0	+11.0	Volts
BPO/UPO	ACOM	-0.5	V <sub>CC</sub> + 0.5	Volts
Junction Temperature			+150	°C
Storage Temperature		-65	+150	°C
Lead Temperature (10 sec)			+300	°C

\*Stresses above those listed under "Absolute Maximum Ratings" may cause permanent damage to the device. This is a stress rating only and functional operation of the device at these or any other conditions above those indicated in the operational sections of this specification is not implied. Exposure to absolute maximum ratings for extended periods may effect device reliability.

## ORDERING GUIDE

Model <sup>1</sup>	Linearity	Temperature Range	Package Option <sup>2,3</sup>
AD1671JQ	±2.5 LSB	0°C to +70°C	Q-28
AD1671KQ	±2 LSB	0°C to +70°C	Q-28
AD1671JP	±2.5 LSB	0°C to +70°C	P-28A
AD1671KP	±2 LSB	0°C to +70°C	P-28A
AD1671AQ	±2.5 LSB	-40°C to +85°C	Q-28
AD1671AP	±2.5 LSB	-40°C to +85°C	P-28A
AD1671SQ	±3 LSB	-55°C to +125°C	Q-28

## NOTES

<sup>1</sup>For details on grade and package offerings screened in accordance with MIL-STD-883, refer to Analog Devices' Military Products Databook or current AD1671/883 data sheet.

<sup>2</sup>P = Plastic Leaded Chip Carrier, Q = Cerdip.

<sup>3</sup>Analog Devices reserves the right to ship side brazed ceramic packages in lieu of cerdip.

## CAUTION

ESD (electrostatic discharge) sensitive device. Electrostatic charges as high as 4000 V readily accumulate on the human body and test equipment and can discharge without detection. Although the AD1671 features proprietary ESD protection circuitry, permanent damage may occur on devices subjected to high energy electrostatic discharges. Therefore, proper ESD precautions are recommended to avoid performance degradation or loss of functionality.



# AD1671

## DEFINITIONS OF SPECIFICATIONS

### INTEGRAL NONLINEARITY (INL)

Integral nonlinearity refers to the deviation of each individual code from a line drawn from “zero” through “full scale.” The point used as “zero” occurs 1/2 LSB (1.22 mV for a 10 V span) before the first code transition (all zeros to only the LSB on). “Full-scale” is defined as a level 1 1/2 LSB beyond the last code transition (to all ones). The deviation is measured from the low side transition of each particular code to the true straight line.

### DIFFERENTIAL LINEARITY ERROR (NO MISSING CODES)

An ideal ADC exhibits code transitions that are exactly 1 LSB apart. DNL is the deviation from the ideal value. Thus every code has a finite width. Guaranteed no missing codes to 11- or 12-bit resolution indicates that all 2048 and 4096 codes, respectively, must be present over all operating ranges. No missing codes to 11 bits (in the case of a 12-bit resolution ADC) also means that no two consecutive codes are missing.

### UNIPOLAR OFFSET

The first transition should occur at a level 1/2 LSB above analog common. Unipolar offset is defined as the deviation of the actual from that point. This offset can be adjusted as discussed later. The unipolar offset temperature coefficient specifies the maximum change of the transition point over temperature, with or without external adjustments.

### BIPOLAR ZERO

In the bipolar mode the major carry transition (0111 1111 1111 to 1000 0000 0000) should occur for an analog value 1/2 LSB below analog common. The bipolar offset error and temperature coefficient specify the initial deviation and maximum change in the error over temperature.

### GAIN ERROR

The last transition (from 1111 1111 1110 to 1111 1111 1111) should occur for an analog value 1 1/2 LSB below the nominal full scale (4.9963 volts for 5.000 volts full scale). The gain error is the deviation of the actual level at the last transition from the ideal level. The gain error can be adjusted to zero as shown in Figures 4 through 7.

### TEMPERATURE COEFFICIENTS

The temperature coefficients for unipolar offset, bipolar zero and gain error specify the maximum change from the initial (+25°C) value to the value at  $T_{MIN}$  or  $T_{MAX}$ .

### POWER SUPPLY REJECTION

One of the effects of power supply error on the performance of the device will be a small change in gain. The specifications show the maximum full-scale change from the initial value with the supplies at the various limits.

## DYNAMIC SPECIFICATIONS

### SIGNAL-TO-NOISE PLUS DISTORTION (S/N+D) RATIO

S/N+D is the ratio of the rms value of the measured input signal to the rms sum of all other spectral components, including harmonics but excluding dc. The value for S/N+D is expressed in decibels.

### EFFECTIVE NUMBER OF BITS (ENOB)

ENOB is calculated from the expression  $(S/N+D) = 6.02N + 1.76$  dB, where N is equal to the effective number of bits.

### TOTAL HARMONIC DISTORTION (THD)

THD is the ratio of the rms sum of the first six harmonic components to the rms value of the measured input signal and is expressed as a percentage or in decibels.

### INTERMODULATION DISTORTION (IMD)

With inputs consisting of sine waves at two frequencies,  $f_a$  and  $f_b$ , any device with nonlinearities will create distortion products of order  $(m + n)$ , at sum and difference frequencies of  $m f_a \pm n f_b$ , where  $m, n = 0, 1, 2, 3, \dots$ . Intermodulation terms are those for which  $m$  or  $n$  is not equal to zero. For example, the second order terms are  $(f_a + f_b)$  and  $(f_a - f_b)$ , and the third order terms are  $(2 f_a + f_b)$ ,  $(2 f_a - f_b)$ ,  $(f_a + 2 f_b)$  and  $(2 f_b - f_a)$ . The IMD products are expressed as the decibel ratio of the rms sum of the measured input signals to the rms sum of the distortion terms. The two signals are of equal amplitude and the peak value of their sum is -0.5 dB from full scale. The IMD products are normalized to a 0 dB input signal.

### PEAK SPURIOUS OR PEAK HARMONIC COMPONENT

The peak spurious or peak harmonic component is the largest spectral component, excluding the input signal and dc. This value is expressed in decibels relative to the rms value of a full-scale input signal.

### APERTURE DELAY

Aperture delay is the difference between the switch delay and the analog delay of the SHA. This delay represents the point in time, relative to the rising edge of ENCODE input, that the analog input is sampled.

### APERTURE JITTER

Aperture jitter is the variation in aperture delay for successive samples.

### FULL POWER BANDWIDTH

The input frequency at which the amplitude of the reconstructed fundamental is reduced by 3 dB for a full-scale input.

## THEORY OF OPERATION

The AD1671 uses a successive subranging architecture. The analog-to-digital conversion takes place in four independent steps or flashes. The sampled analog input signal is subranged to an intermediate residue voltage for the final 12-bit result by utilizing multiple flashes with subtraction DACs (see the AD1671 functional block diagram).

The AD1671 can be configured to operate with unipolar (0 V to +5 V, 0 V to +2.5 V) or bipolar ( $\pm 5$  V,  $\pm 2.5$  V) inputs by connecting AIN (Pins 22, 23), SHA OUT (Pin 25) and BPO/UPO (Pin 26) as shown in Figure 2.

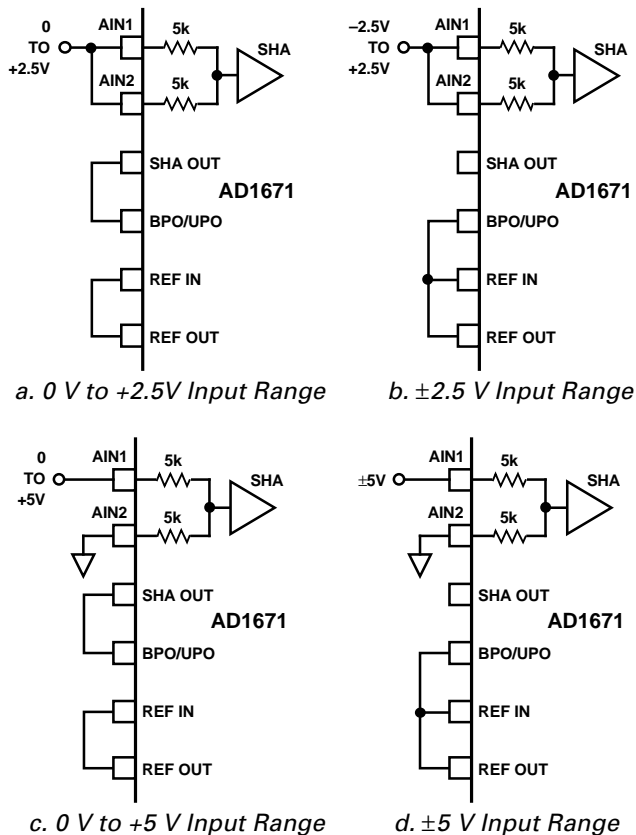

Figure 2. AD1671 Input Range Connections

The AD1671 conversion cycle begins by simply providing an active HIGH level on the ENCODE pin (Pin 17). The rising edge of the ENCODE pulse starts the conversion. The falling edge of the ENCODE pulse is specified to operate within a window of time, less than 50 ns after the rising edge of ENCODE or after the falling edge of DAV. The time window prevents digitally coupled noise from being introduced during the final stages of conversion. An internal timing generator circuit accurately controls SHA, flash and DAC timing.

Upon receipt of an ENCODE command the input voltage is held by the front-end SHA and the first 3-bit flash converts the analog input voltage. The 3-bit result is passed to a correction logic register and a segmented current output DAC. The DAC output is connected through a resistor (within the Range/Span Select Block) to SHA OUT. A residue voltage is created by subtracting the DAC output from SHA OUT, which is less than one eighth of the full-scale analog input. The second flash has

an input range that is configured with one bit of overlap with the previous DAC. The overlap allows for errors during the flash conversion. The first residue voltage is connected to the second 3-bit flash and to the noninverting input of a high speed, differential, gain of eight amplifier. The second flash result is passed to the correction logic register and to the second segmented current output DAC. The output of the second DAC is connected to the inverting input of the differential amplifier. The differential amplifier output is connected to a two-step, backend, 8-bit flash. This 8-bit flash consists of coarse and fine flash converters. The result of the coarse 4-bit flash converter, also configured to overlap one bit of DAC 2, is connected to the correction logic register and selects one of 16 resistors from which the fine 4-bit flash will establish its span voltage. The fine 4-bit flash is connected directly to the output latches.

The internal timing generator automatically places the SHA into the acquire mode when DAV goes LOW. Upon completion of conversion (when DAV is set HIGH), the SHA has acquired the analog input to the specified level of accuracy and will remain in the sample mode until the next ENCODE command.

The AD1671 will flag an out-of-range condition when the input voltage exceeds the analog input range. OTR (Pin 15) is active HIGH when an out-of-range high or low condition exists. Bits 1–12 are HIGH when the analog input voltage is greater than the selected input range and LOW when the analog input is less than the selected input range.

## AD1671 DYNAMIC PERFORMANCE

The AD1671 is specified for dc and dynamic performance. A sampling converter's dynamic performance reflects both quantizer and sample-and-hold amplifier (SHA) performance. Quantizer nonlinearities, such as INL and DNL, can degrade dynamic performance. However, a SHA is the critical element which has to accurately sample fast slewing analog input signals. The AD1671's high performance, low noise, patented on-chip SHA minimizes distortion and noise specifications. Nonlinearities are minimized by using a fast slewing, low noise architecture and subregulation of the sampling switch to provide constant offsets (therefore reducing input signal dependent nonlinearities).

Figure 3 is a typical 2k point Fast Fourier Transform (FFT) plot of a 100 kHz input signal sampled at 1 MHz. The fundamental amplitude is set at  $-0.5$  dB to avoid input signal clipping of offset or gain errors. Note the total harmonic distortion is approximately  $-81$  dB, signal to noise plus distortion is 71 dB and the spurious free dynamic range is 84 dB.

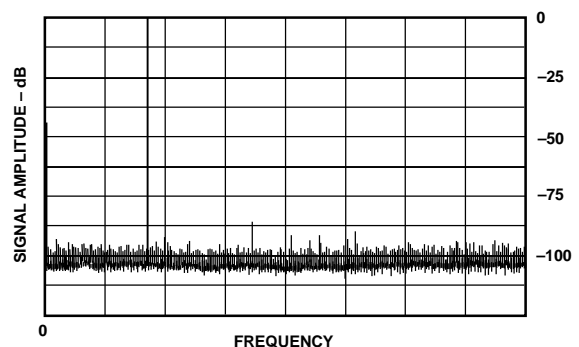

Figure 3. AD1671 FFT Plot,  $f_{IN} = 100$  kHz,  $f_{SAMPLE} = 1$  MHz

# AD1671

Figure 4 plots both  $S/(N+D)$  and Effective Number of Bits (ENOB) for a 100 kHz input signal sampled from 666 kHz to 1.25 MHz.

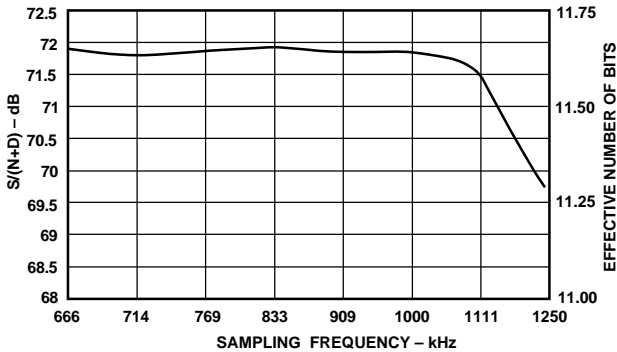

Figure 4.  $S/(N+D)$  vs. Sampling Frequency,  $f_{IN} = 100$  kHz

Figure 5 is a THD plot for a full-scale 100 kHz input signal with the sample frequency swept from 666 kHz to 1.25 MHz.

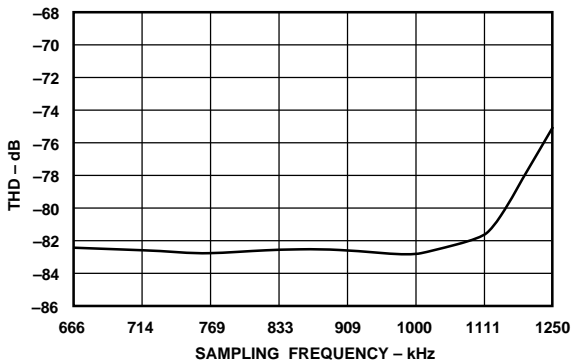

Figure 5. THD vs. Sampling Rate,  $f_{IN} = 100$  kHz

The AD1671's SFDR performance is ideal for use in communication systems such as high speed modems and digital radios. The SFDR is better than 84 dB with sample rates up to 1.11 MHz and increases as the input signal amplitude is attenuated by approximately 3 dB. Note also the SFDR is typically better than 80 dB with input signals attenuated by up to -7 dB.

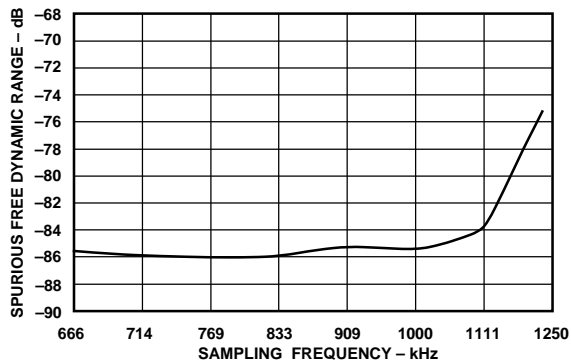

Figure 6. Spurious Free Dynamic Range vs. Sampling Rate,  $f_{IN} = 100$  kHz

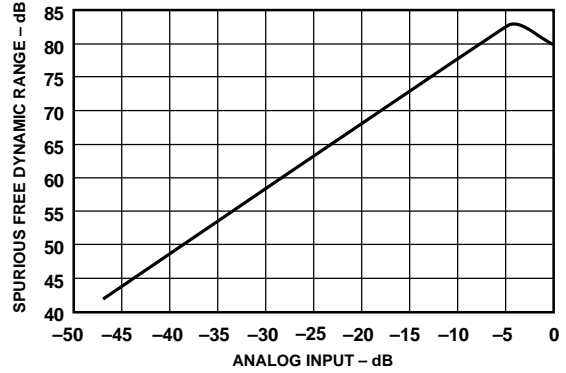

Figure 7. Spurious Free Dynamic Range vs. Input Amplitude,  $f_{IN} = 250$  kHz

## APPLYING THE AD1671

### GROUNDING AND DECOUPLING RULES

Proper grounding and decoupling should be a primary design objective in any high speed, high resolution system. The AD1671 separates analog and digital grounds to optimize the management of analog and digital ground currents in a system. The AD1671 is designed to minimize the current flowing from REF COM (Pin 20) by directing the majority of the current from  $V_{CC}$  (+5 V-Pin 28) to  $V_{EE}$  (-5 V-Pin 1). Minimizing analog ground currents hence reduces the potential for large ground voltage drops. This can be especially true in systems that do not utilize ground planes or wide ground runs. REF COM is also configured to be code independent, therefore reducing input dependent analog ground voltage drops and errors. Code dependent ground current is diverted to ACOM (Pin 27). Also critical in any high speed digital design is the use of proper digital grounding techniques to avoid potential CMOS "ground bounce." Figure 3 is provided to assist in the proper layout, grounding and decoupling techniques.

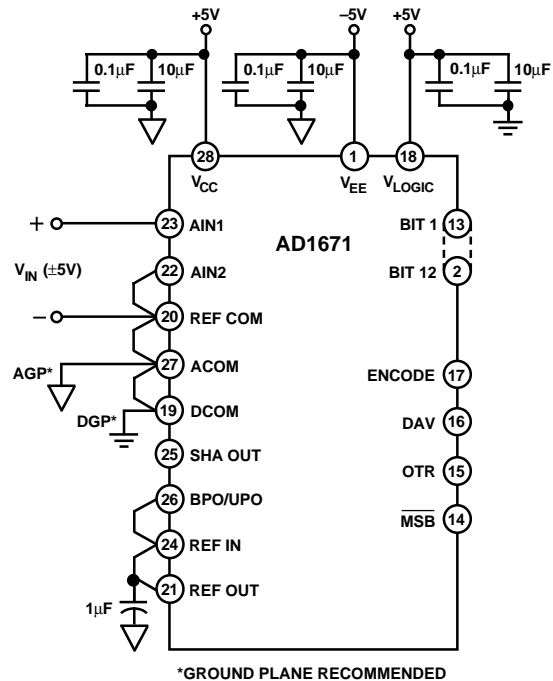

Figure 8. AD1671 Grounding and Decoupling



Table I is a list of grounding and decoupling rules that should be reviewed before laying out a printed circuit board.

**Table I. Grounding and Decoupling Guidelines**

Power Supply Decoupling	Comment
Capacitor Values	0.1 $\mu\text{F}$ (Ceramic) and 1 $\mu\text{F}$ (Tantalum) Surface Mount Chip Capacitors Recommended to Reduce Lead Inductance
Capacitor Locations	Directly at Positive and Negative Supply Pins to Common Ground Plane
<b>Reference (REF OUT)</b>	
Capacitor Value	1 $\mu\text{F}$ (Tantalum) to ACOM
<b>Grounding</b>	
Analog Ground	Ground Plane or Wide Ground Return Connected to the Analog Power Supply
Reference Ground (REF COM)	Critical Common Connections Should be Star Connected to REF COM (as Shown in Figure 8)
Digital Ground	Ground Plane or Wide Ground Return Connected to the Digital Power Supply
Analog and Digital Ground	Connected Together Once at the AD1671

### UNIPOLAR (0 V TO +5 V) CALIBRATION

The AD1671 is factory trimmed to minimize offset, gain and linearity errors. In some applications the offset and gain errors of the AD1671 need to be externally adjusted to zero. This is accomplished by trimming the voltage at AIN2 (Pin 22). The circuit in Figure 9 is recommended for calibrating offset and gain errors of the AD1671 when configured in the 0 V to +5 V input range. If the offset trim resistor R1 is used, it should be trimmed as follows, although a different offset can be set for a particular system requirement. This circuit will give approximately  $\pm 5$  mV of offset trim range. Nominally the AD1671 is intended to have a 1/2 LSB offset so that the exact analog input for a given code will be in the middle of that code (halfway between the transitions to the codes above it and below it). Thus, the first transition (from 0000 0000 0000 to 0000 0000 0001) will occur for an input level of +1/2 LSB (0.61 mV for 5 V range).

The gain trim is done by applying a signal 1 1/2 LSBs below the nominal full scale (4.998 V for a 5 V range). Trim R2 to give the last transition (1111 1111 1110 to 1111 1111 1111). This circuit will give approximately  $\pm 0.5\%$  FS of adjustment range.

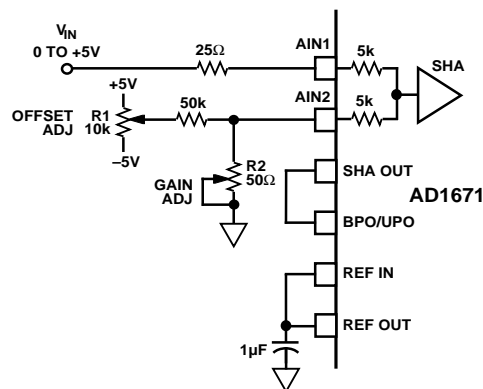

Figure 9. Unipolar (0 V to +5 V) Calibration

### BIPOLAR ( $\pm 5$ V) CALIBRATION

The connections for the bipolar  $\pm 5$  V input range is shown in Figure 10.

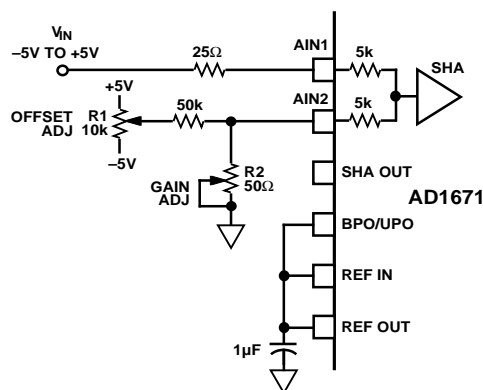

Figure 10. Bipolar ( $\pm 5$  V) Calibration

Bipolar calibration is similar to unipolar calibration. First, a signal 1/2 LSB above negative full scale ( $-4.9988$  V) is applied and R1 is trimmed to give the first transition (0000 0000 0000 to 0000 0000 0001). Then a signal 1 1/2 LSB below positive full scale ( $+4.9963$  V) is applied and R2 is trimmed to give the last transition (1111 1111 1110 to 1111 1111 1111).

# AD1671

## UNIPOLAR (0 V TO +2.5 V) CALIBRATION

The connections for the 0 V to +2.5 V input range calibration is shown in Figure 11. Figure 11 shows an example of how the offset error can be trimmed in front of the AD1671. The procedure for trimming the offset and gain errors is the same as for the unipolar 5 V range.

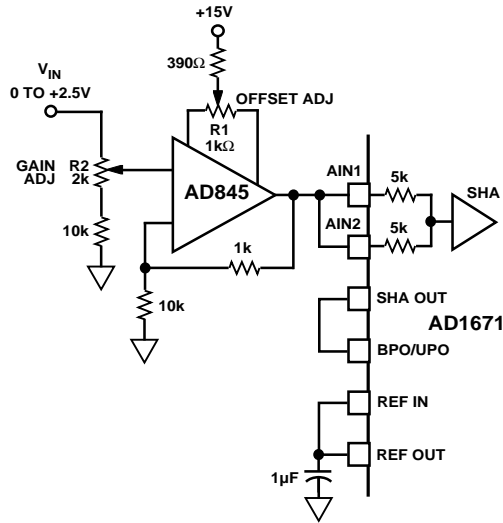

Figure 11. Unipolar (0 V to +2.5 V) Calibration

## BIPOLAR ( $\pm 2.5$ V) CALIBRATION

The connections for the bipolar  $\pm 2.5$  V input range is shown in Figure 12.

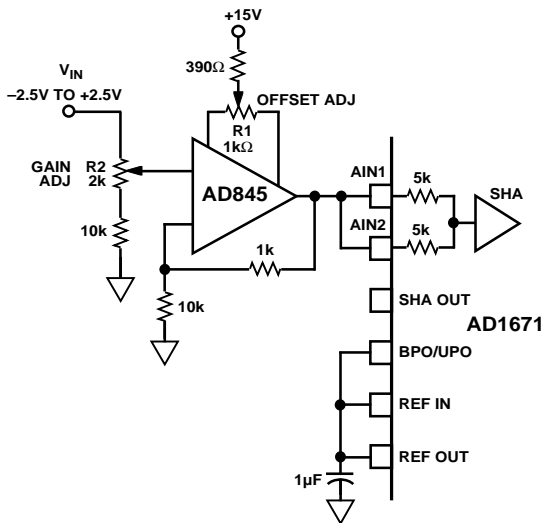

Figure 12. Bipolar ( $\pm 2.5$  V) Calibration

## OUTPUT LATCHES

Figure 13 shows the AD1671 connected to the 74HC574 octal D-type edge-triggered latches with 3-state outputs. The latch can drive highly capacitive loads (i.e., bus lines, I/O ports) while maintaining the data signal integrity. The maximum setup and hold times of the 574 type latch must be less than 20 ns ( $t_{DD}$

and  $t_{SS}$  minimum). To satisfy the requirements of the 574 type latch the recommended logic families are S, AS, ALS, F or BCT. New data from the AD1671 is latched on the rising edge of the DAV (Pin 16) output pulse. Previous data can be latched by inverting the DAV output with a 7404 type inverter.

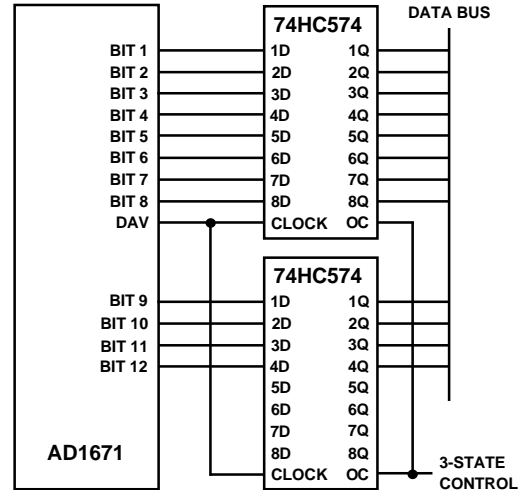

Figure 13. AD1671 to Output Latches

## OUT OF RANGE

An out-of-range condition exists when the analog input voltage is beyond the input range (0 V to +2.5 V, 0 V to +5 V,  $\pm 2.5$  V,  $\pm 5$  V) of the converter OTR (Pin 15) is set low when the analog input voltage is within the analog input range. OTR is set HIGH and will remain HIGH when the analog input voltage exceeds the input range by typically 1/2 LSB (OTR transition is tested to  $\pm 6$  LSBs of accuracy) from the center of the  $\pm$ full-scale output codes. OTR will remain HIGH until the analog input is within the input range and another conversion is completed. By logical ANDing OTR with the MSB and its complement, overrange high or underrange low conditions can be detected. Table II is a truth table for the over/under range circuit in Figure 14. Systems requiring programmable gain conditioning prior to the AD1671 can immediately detect an out-of-range condition, thus eliminating gain selection iterations.

Table II. Out-of-Range Truth Table

OTR	MSB	Analog Input Is
0	0	In Range
0	1	In Range
1	0	Underrange
1	1	Overrange

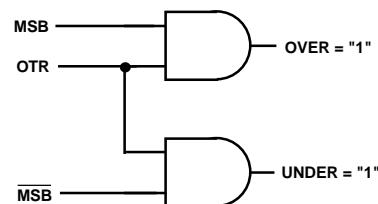

Figure 14. Overrange or Underrange Logic

Table III. Output Data Format

Input Range	Coding	Analog Input <sup>1</sup>	Digital Output	OTR <sup>2</sup>
0 V to +2.5 V	Straight Binary	≤ -0.0003 V	0000 0000 0000	1
		0 V	0000 0000 0000	0
		+2.5 V	1111 1111 1111	0
		≥ +2.5003 V	1111 1111 1111	1
0 V to +5 V	Straight Binary	≤ -0.0006 V	0000 0000 0000	1
		0 V	0000 0000 0000	0
		+5 V	1111 1111 1111	0
		≥ +5.0006 V	1111 1111 1111	1
-2.5 V to +2.5 V	Offset Binary	≤ -2.5006 V	0000 0000 0000	1
		-2.5 V	0000 0000 0000	0
		+2.5 V	1111 1111 1111	0
		≥ +2.4994 V	1111 1111 1111	1
-5 V to +5 V	Offset Binary	≤ -5.0012 V	0000 0000 0000	1
		-5 V	0000 0000 0000	0
		+5 V	1111 1111 1111	0
		≥ +4.9988 V	1111 1111 1111	1
-2.5 V to +2.5 V	Twos Complement (Using MSB)	≤ -2.5006 V	1000 0000 0000	1
		-2.5 V	1000 0000 0000	0
		+2.5 V	0111 1111 1111	0
		≥ +2.4994 V	0111 1111 1111	1
-5 V to +5 V	Twos Complement (Using MSB)	≤ -5.0012 V	1000 0000 0000	1
		-5 V	1000 0000 0000	0
		+5 V	0111 1111 1111	0
		≥ +4.9988 V	0111 1111 1111	1

## NOTES

<sup>1</sup>Voltages listed are with offset and gain errors adjusted to zero.<sup>2</sup>Typical performance.**OUTPUT DATA FORMAT**

The AD1671 provides both MSB and  $\overline{\text{MSB}}$  outputs, delivering data in positive true straight binary for unipolar input ranges and positive true offset binary or twos complement for bipolar input ranges. Straight binary coding is used for systems that accept positive-only signals. If straight binary coding is used with bipolar input signals, a 0 V input would result in a binary output of 2048. The application software would have to subtract 2048 to determine the true input voltage. Host registers typically perform math on signed integers and assume data is in that format. Twos complement format minimizes software overhead which is especially important in high speed data transfers, such as a DMA operation. The CPU is not bogged down performing data conversion steps, hence the total system throughput is increased.

**OPTIONAL EXTERNAL REFERENCE**

The AD1671 includes an onboard +2.5 V reference. The reference input pin (REF IN) can be connected to reference output pin (REF OUT) or a standard external +2.5 V reference can be selected to meet specific system requirements. Fast switching input dependent currents are modulated at the reference input. The reference input voltage can be held with the use of a capacitor. To prevent the AD1671's onboard reference from oscillating when not connected to REF IN, REF OUT must be

connected to +5 V. It is possible to connect REF OUT to +5 V due to its output circuit implementation which shuts down the reference.

**I<sub>LOGIC</sub> VS. CONVERSION RATE**

Figure 15 is the typical logic supply current vs. conversion rate for various capacitor loads on the digital outputs.

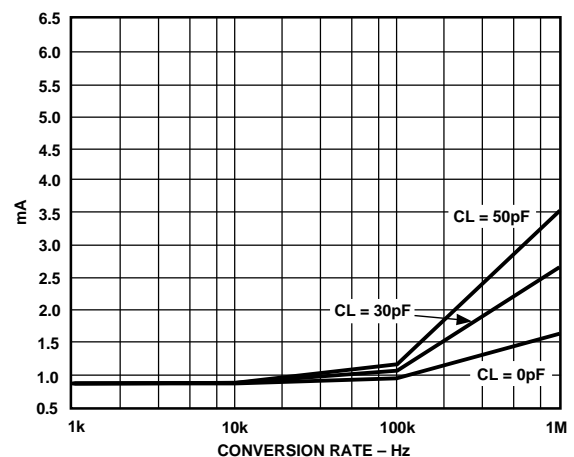

Figure 15. I<sub>LOGIC</sub> vs. Conversion Rate for Various Capacitive Loads on the Digital Outputs

# AD1671

## APPLICATIONS

### AD1671 TO ADSP-2100A

Figure 16 demonstrates the AD1671 to ADSP-2100A interface. The 2100A with a clock frequency of 12.5 MHz can execute an instruction in one 80 ns cycle. The AD1671 is configured to perform continuous time sampling. The DAV output of the AD1671 is asserted at the end of each conversion. DAV can be used to latch the conversion result into the two 574 octal D-latches. The falling edge of the sampling clock is used to generate an interrupt (IRQ3) for the processor. Upon interrupt, the ADSP-2100A starts a data memory read by providing an address on the DMA bus. The decoded address generates OE for the D-latches and the processor reads their output over the Data (D) bus. The conversion result is read within a single processor cycle.

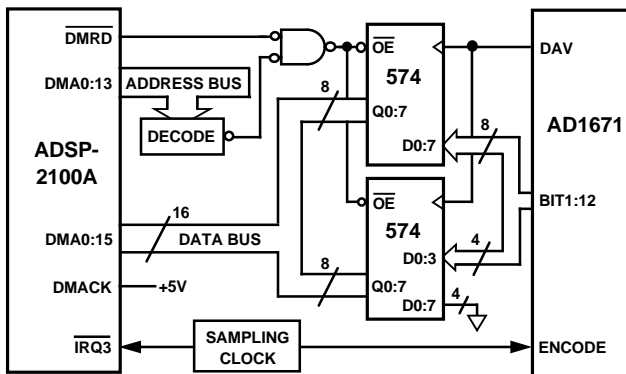

Figure 16. AD1671 to ADSP-2100A Interface

### AD1671 TO ADSP-2101/2102

Figure 17 is identical to the 2100A interface except the sampling clock is used to generate an interrupt (IRQ2) for the processor. Upon interrupt the ADSP-2100A starts a data memory read by providing an address on the address (A) bus. The decode address generates OE for the D-latches and the processor reads their output over the Data (D) bus. Reading the conversion result is thus completed within a single processor cycle.

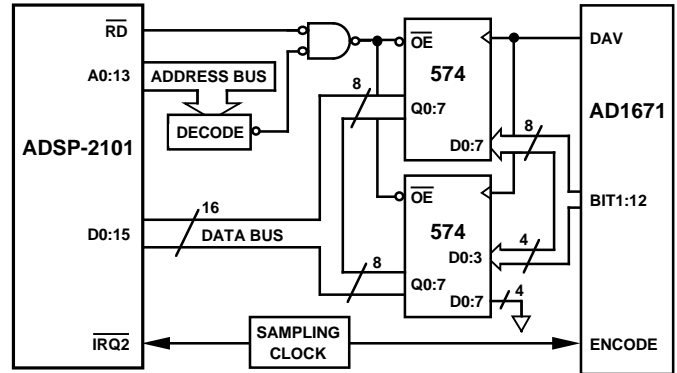

Figure 17. AD1671 to ADSP-2101/ADSP-2102 Interface

## COMPONENT LIST

<b>Parts List Reference Designator</b>	<b>Type Description</b>
R1, R2	Resistor, 5%, 0.5 W, 100 $\Omega$
R3, R4, R5	Resistor, 1%, 49.9 $\Omega$
R6	100 $\Omega$ Trim Potentiometer
R7	Resistor 1%, 4.99 k $\Omega$ Optional
R8	X $\Omega$ Trim Potentiometer, Optional
R9, R11	Resistor, 1%, 4.99 k $\Omega$
R10	Resistor, 1%, 10 k $\Omega$
R12	Resistor, 1%, 2.49 k $\Omega$
R13	Resistor, 1%, 787 $\Omega$
R14	Resistor, 1%, 249 $\Omega$
R15–R28	Resistor, 5%, 22 $\Omega$
C1, C3, C5	Cap, Tantalum, 22 $\mu$ F
C2, C4, C6, C8, C10	Cap, Ceramic, 0.01 $\mu$ F
C7, C9, C15, C16	Cap, Tantalum, 10 $\mu$ F
C11, C12, C13, C14, C17	Cap, Ceramic, 0.1 $\mu$ F
C18	Cap, Ceramic, 1.0 $\mu$ F
C19–C22	Cap, Ceramic, 0.1 $\mu$ F
C23	Cap, Mica, 100 pF
C24	Cap, Ceramic, 0.001 $\mu$ F
U1	78L05 +5 V Regulator
U2	79L05 –5 V Regulator
U3	AD1671
U4–U5	74HC573 Drivers
U6	AD568
W1–W3	BNC Jacks
J1–J15	Jumpers and Headers
S1	Metal Binding Posts
S2	Wide 28-Pin Socket
S3	Narrow 20-Pin Socket
SW1–SW3	Narrow 24-Pin Socket
TP1, TP2, TP4–TP6	SECMA SPDT Switch
TP3, TP7, TP10, TP13	Test Point, Red
TP8, TP9, TP11, TP12, TP14	Test Point, Black
P1	Test Point, White
	40-Pin Connector Male + Hooks

# AD1671

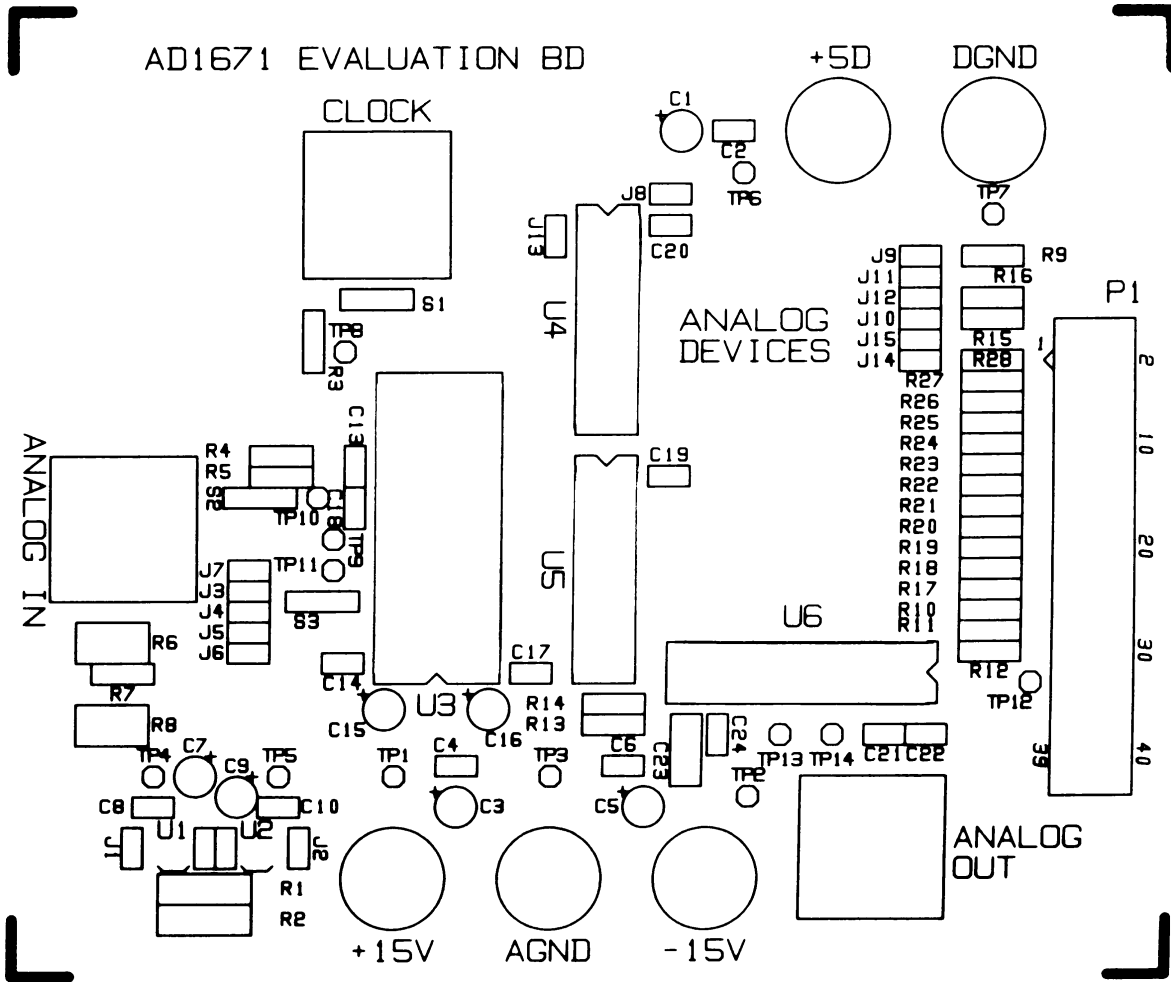

Figure 18. AD1671/EB PCB Layout—Silkscreen Layer

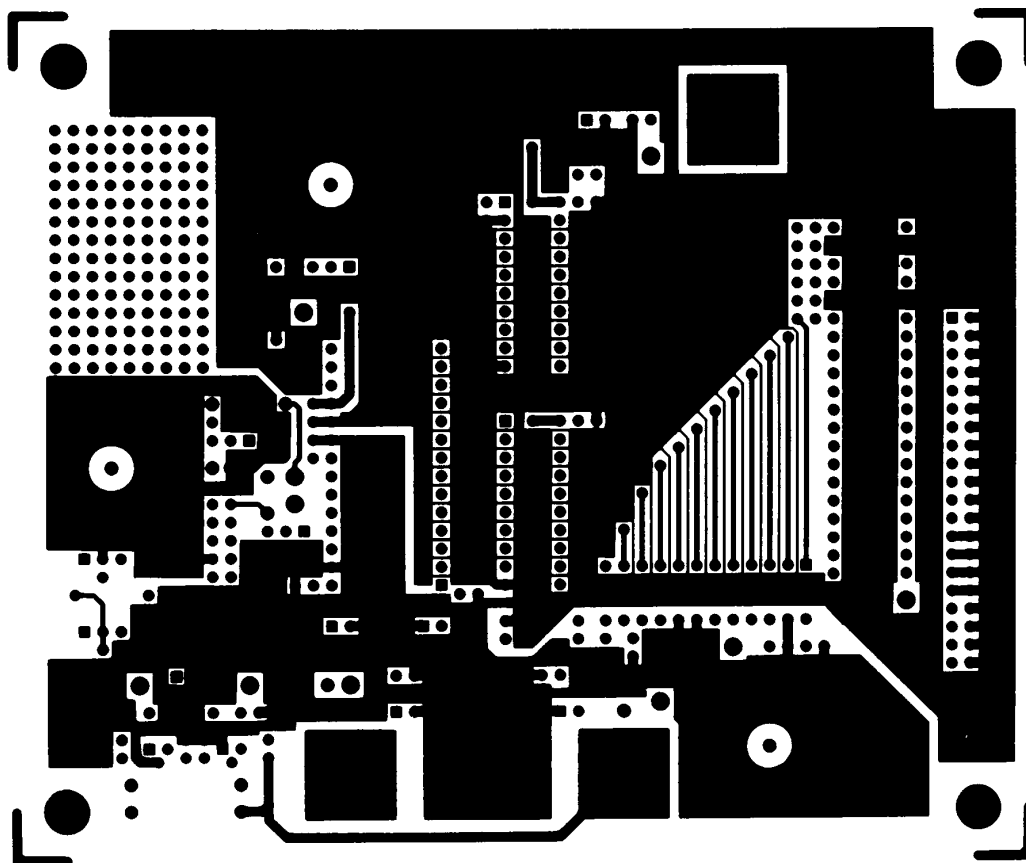

Figure 19. AD1671/EB PCB Layout—Component Side

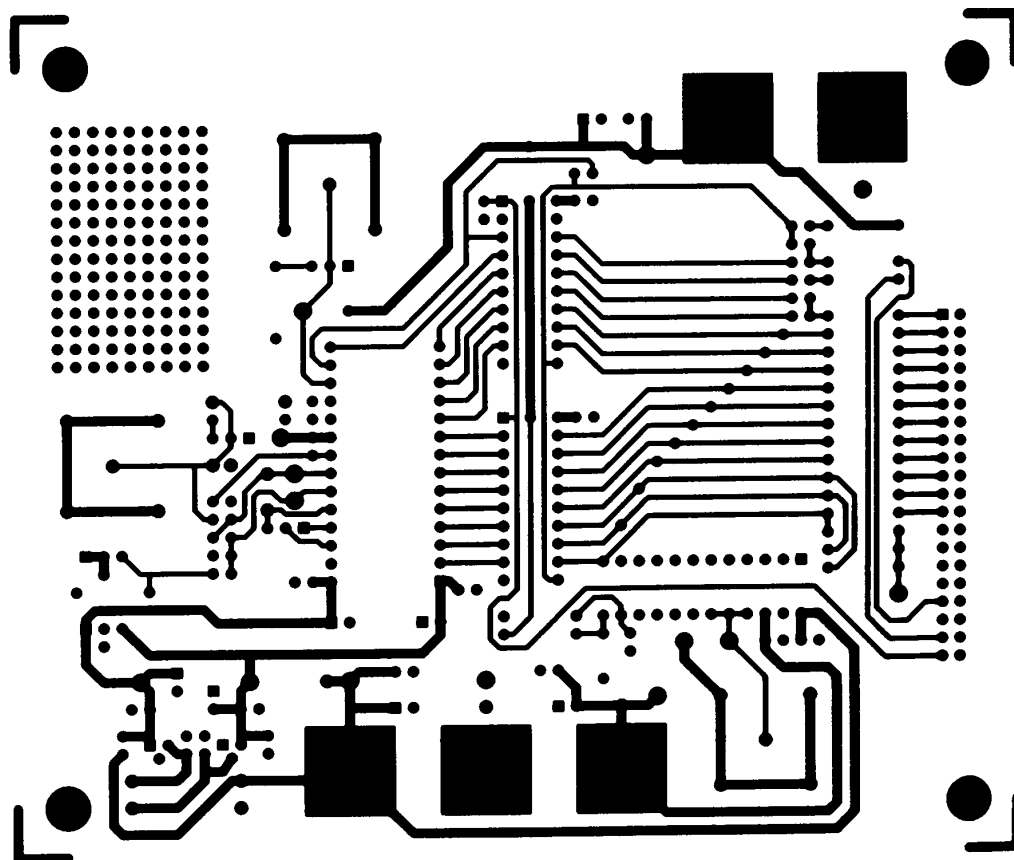
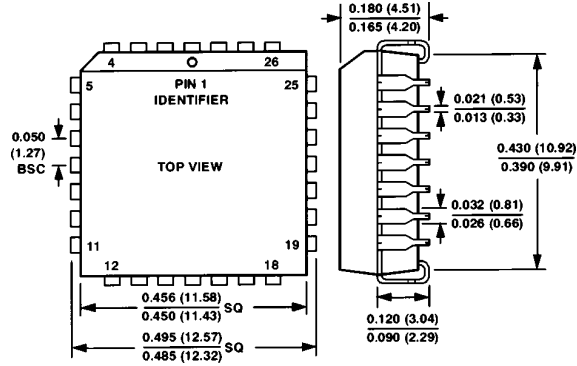

Figure 20. AD1671/EB PCB Layout—Solder Side

**OUTLINE DIMENSIONS**

Dimensions shown in inches and (mm).

**28-Lead PLCC (P-28A) Package**



**28-Pin Cerdip (Q-28) Package**

