

**DUAL POWER OPERATIONAL AMPLIFIERS**

- OUTPUT CURRENT TO 1 A
- OPERATES AT LOW VOLTAGES
- SINGLE OR SPLIT SUPPLY
- LARGE COMMON-MODE AND DIFFERENTIAL MODE RANGE
- GROUND COMPATIBLE INPUTS
- LOW SATURATION VOLTAGE
- THERMAL SHUTDOWN

**DESCRIPTION**

The L272 is a monolithic integrated circuits in Powerdip, Minidip and SO packages intended for use as power operational amplifiers in a wide range of applications including servo amplifiers and power supplies, compact disc, VCR, etc.

The high gain and high output power capability provide superior performance whatever an operational amplifier/power booster combination is required.

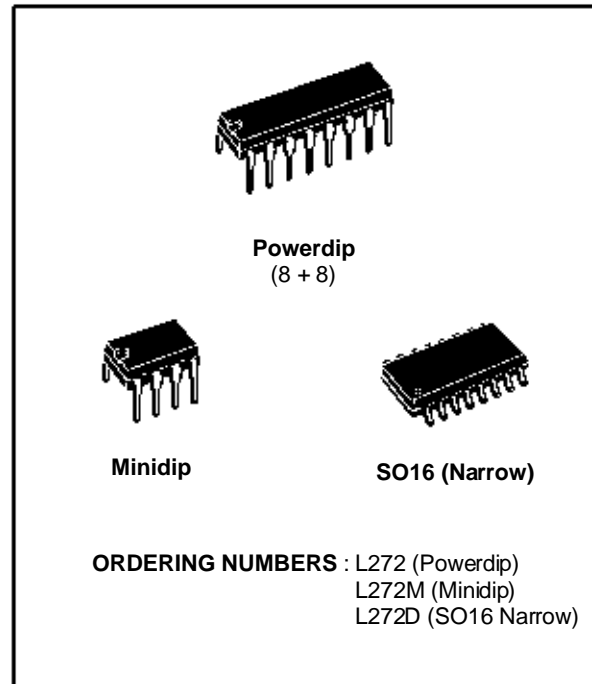

**PIN CONNECTIONS (top view)**

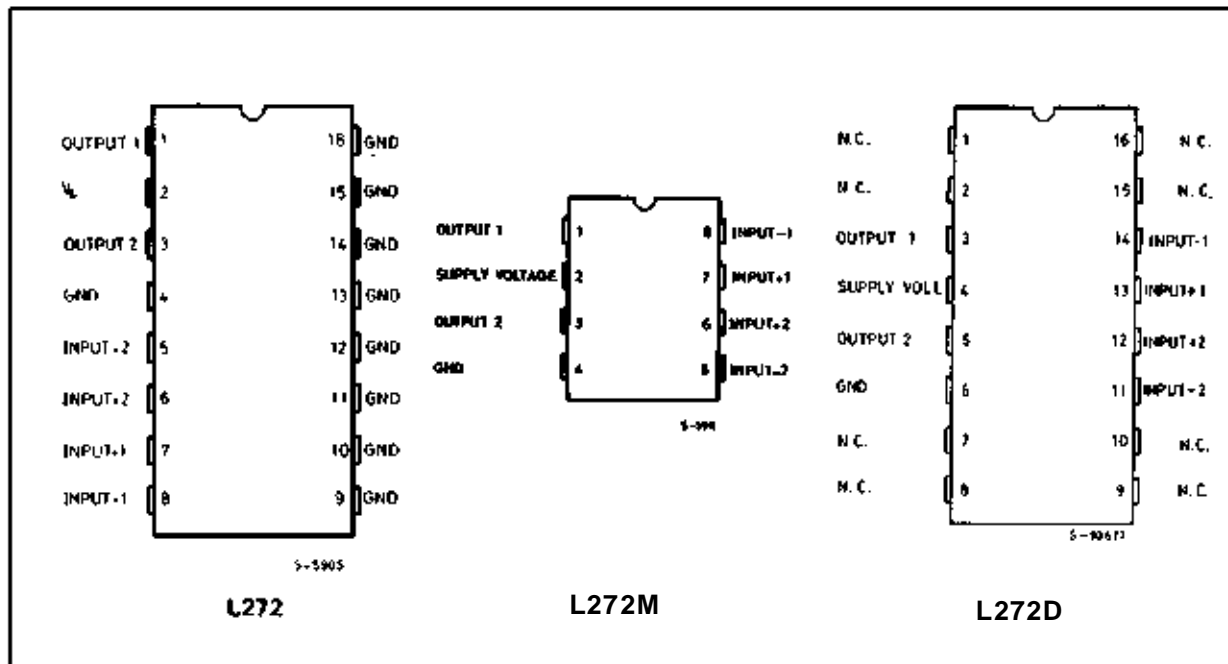

BLOCK DIAGRAMS

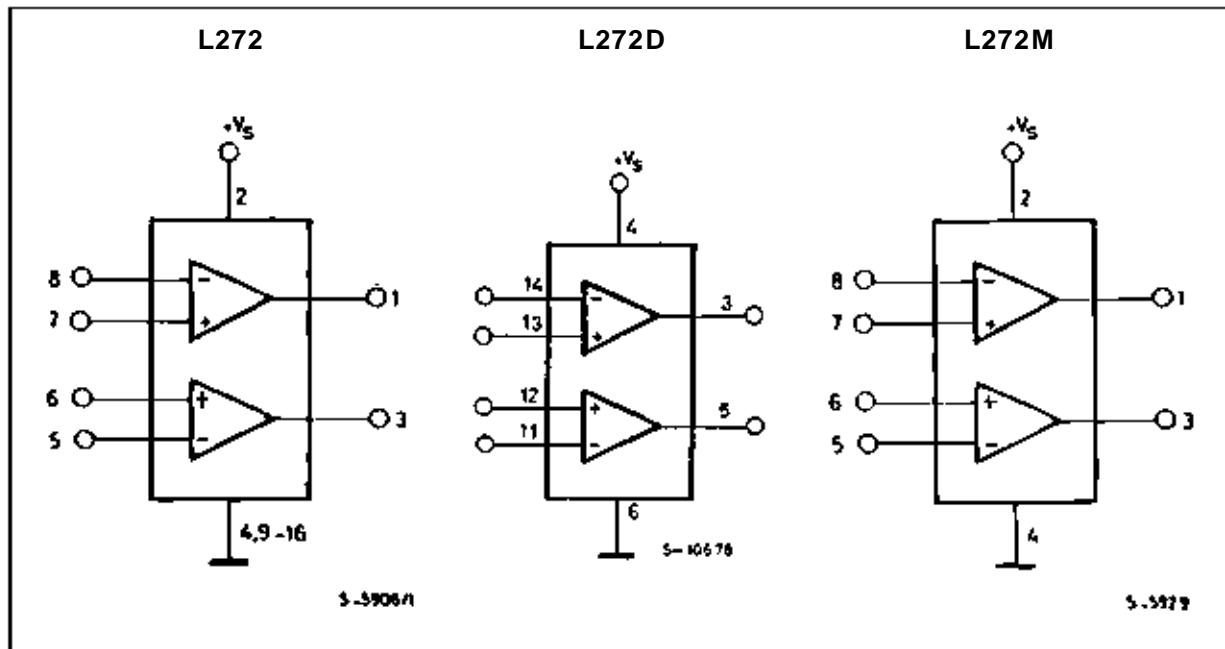

SCHEMATIC DIAGRAM (one only)

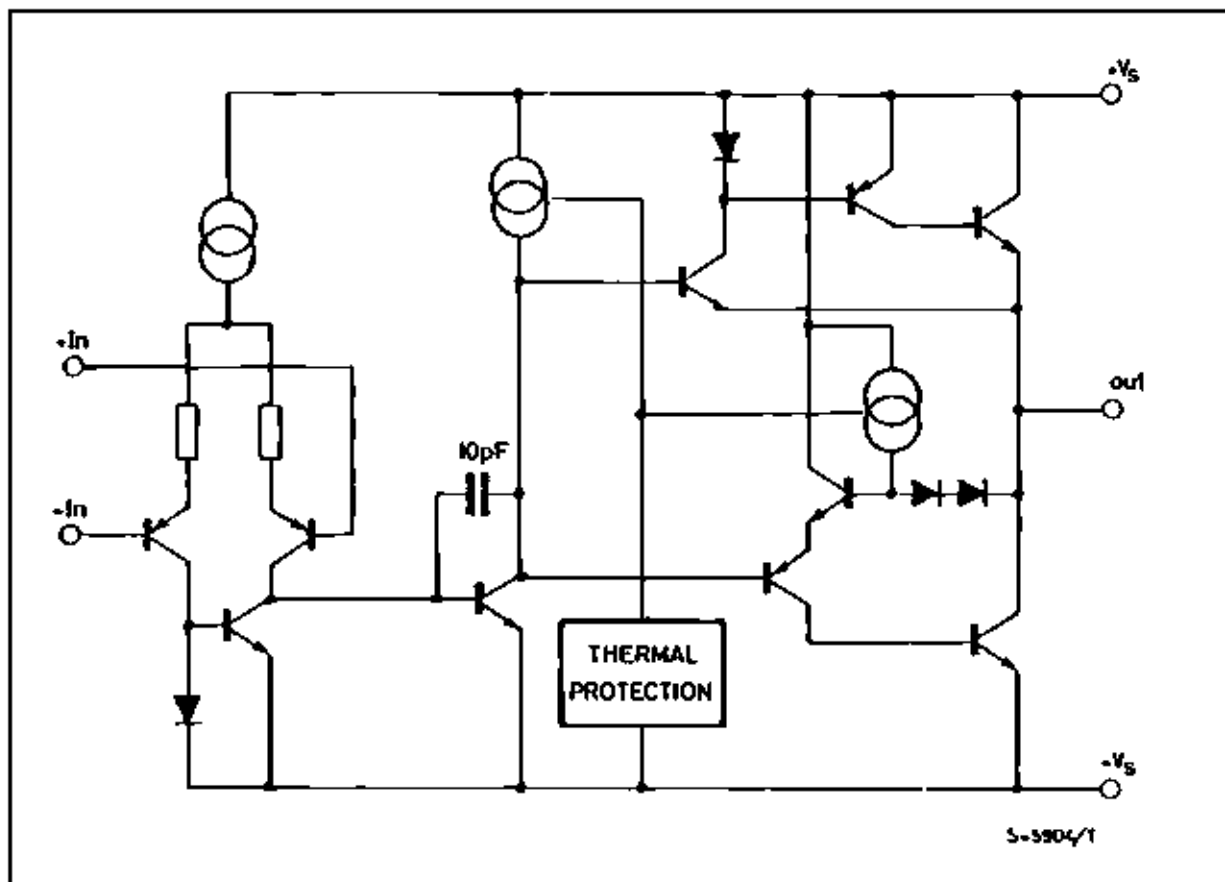

## ABSOLUTE MAXIMUM RATINGS

Symbol	Parameter	Value	Unit
$V_s$	Supply Voltage	28	V
$V_i$	Input Voltage	$V_s$	
$V_i$	Differential Input Voltage	$\pm V_s$	
$I_o$	DC Output Current	1	A
$I_p$	Peak Output Current (non repetitive)	1.5	A
$P_{tot}$	Power Dissipation at: $T_{amb} = 80^\circ\text{C}$ (L272), $T_{amb} = 50^\circ\text{C}$ (L272M), $T_{case} = 90^\circ\text{C}$ (L272D) $T_{case} = 75^\circ\text{C}$ (L272)	1.2 5	W W
$T_{op}$	Operating Temperature Range (L272D)	- 40 to 85	$^\circ\text{C}$
$T_{stg}, T_j$	Storage and Junction Temperature	- 40 to 150	$^\circ\text{C}$

## THERMAL DATA

Symbol	Parameter		Powerdip	SO16	Minidip	Unit
$R_{th\ j-case}$	Thermal Resistance Junction-pins	Max.	15	-	* 70	$^\circ\text{C}/\text{W}$
$R_{th\ j-amb}$	Thermal Resistance Junction-ambient	Max.	70	-	100	$^\circ\text{C}/\text{W}$
$R_{th\ j-alumina}$	Thermal Resistance Junction-alumina	Max.	-	** 50	-	$^\circ\text{C}/\text{W}$

\* Thermal resistance junction-pin 4

\*\* Thermal resistance junctions-pins with the chip soldered on the middle of an alumina supporting substrate measuring 15x 20mm; 0.65mm thickness and infinite heatsink.

ELECTRICAL CHARACTERISTICS ( $V_s = 24\text{V}$ ,  $T_{amb} = 25^\circ\text{C}$  unless otherwise specified)

Symbol	Parameter	Test Conditions	Min.	Typ.	Max.	Unit
$V_s$	Supply Voltage		4		28	V
$I_s$	Quiescent Drain Current	$V_O = \frac{V_s}{2}$ $V_s = 24\text{V}$ $V_s = 12\text{V}$		8 7.5	12 11	mA mA
$I_b$	Input Bias Current			0.3	2.5	$\mu\text{A}$
$V_{os}$	Input Offset Voltage			15	60	mV
$I_{os}$	Input Offset Current			50	250	nA
SR	Slew Rate			1		V/ $\mu\text{s}$
B	Gain-bandwidth Product			350		kHz
$R_i$	Input Resistance		500			k $\Omega$
$G_v$	O. L. Voltage Gain	$f = 100\text{Hz}$ $f = 1\text{kHz}$	60	70 50		dB dB
$e_N$	Input Noise Voltage	$B = 20\text{kHz}$		10		$\mu\text{V}$
$I_N$	Input Noise Current	$B = 20\text{kHz}$		200		pA
CRR	Common Mode Rejection	$f = 1\text{kHz}$	60	75		dB
SVR	Supply Voltage Rejection	$f = 100\text{Hz}$ , $R_G = 10\text{k}\Omega$ , $V_R = 0.5\text{V}$ $V_s = 24\text{V}$ $V_s = \pm 12\text{V}$ $V_s = \pm 6\text{V}$	54	70 62 56		dB
$V_o$	Output Voltage Swing	$I_p = 0.1\text{A}$ $I_p = 0.5\text{A}$	21	23 22.5		V V
$C_s$	Channel Separation	$f = 1\text{kHz}$ ; $R_L = 10\Omega$ , $G_v = 30\text{dB}$ $V_s = 24\text{V}$ $V_s = \pm 6\text{V}$		60 60		dB
d	Distortion	$f = 1\text{kHz}$ , $G_v = 3\text{dB}$ , $V_s = 24\text{V}$ , $R_L = \infty$		0.5		%
$T_{sd}$	Thermal Shutdown Junction Temperature			145		$^\circ\text{C}$

**Figure 1 :** Quiescent Current versus Supply Voltage

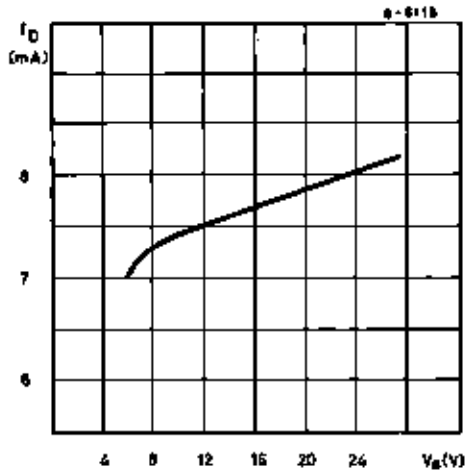

**Figure 2 :** Quiescent Drain Current versus Temperature

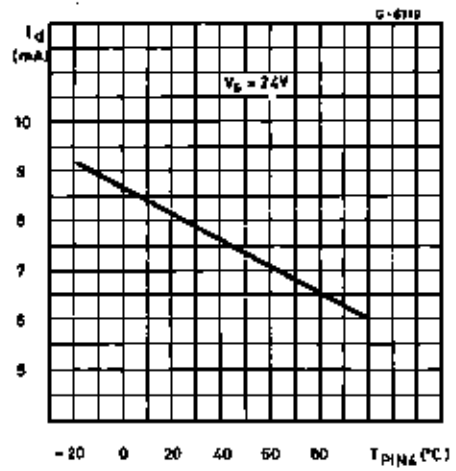

**Figure 3 :** Open Loop Voltage Gain

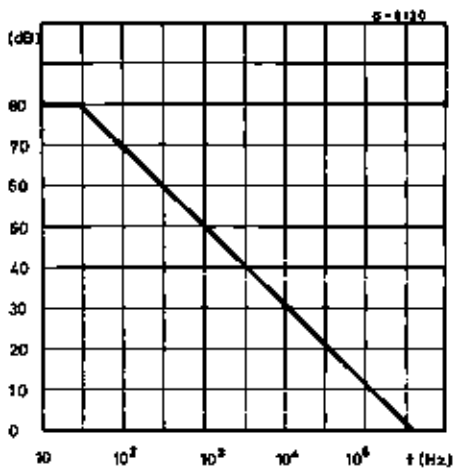

**Figure 4 :** Output Voltage Swing versus Load Current

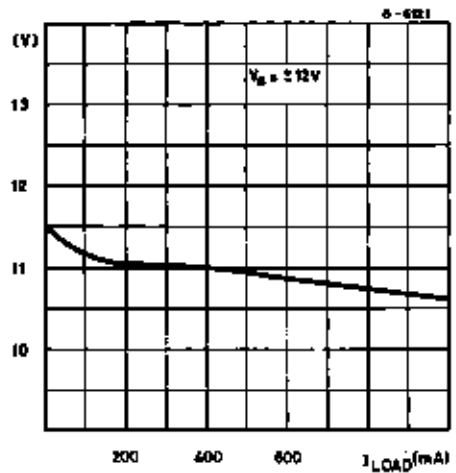

**Figure 5 :** Output Voltage Swing versus Load Current

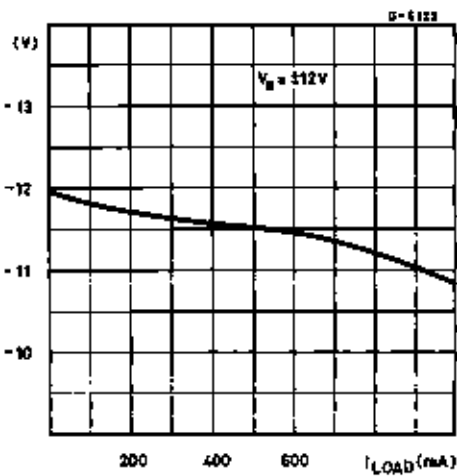

**Figure 6 :** Supply Voltage Rejection versus Frequency

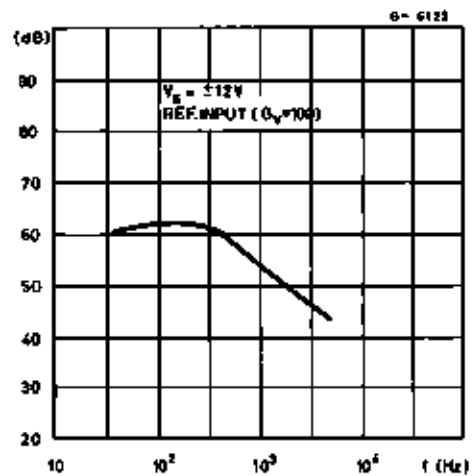

**Figure 7 :** Channel Separation versus Frequency

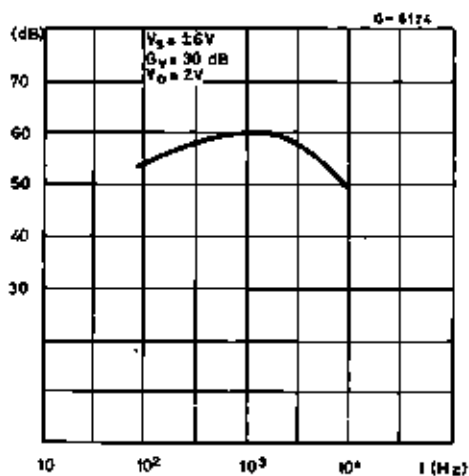

**Figure 8 :** Common Mode Rejection versus Frequency

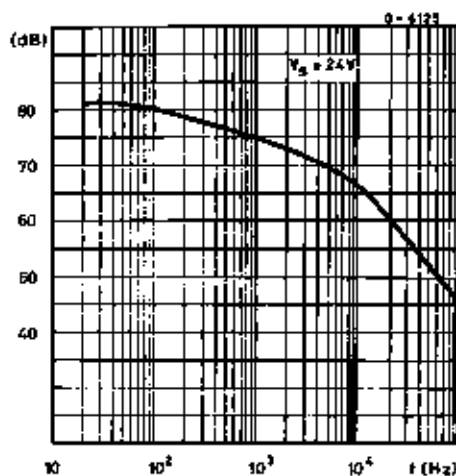

**APPLICATION SUGGESTION**

**NOTE**

In order to avoid possible instability occurring into final stage the usual suggestions for the linear power stages are useful, as for instance :

- layout accuracy ;
- a 100nF capacitor connected between supply pins and ground ;
- boucherot cell (0.1 to 0.2  $\mu$ F + 1  $\Omega$  series) between outputs and ground or across the load.

**Figure 9 :** Bidirectional DC Motor Control with  $\mu$ P Compatible Inputs

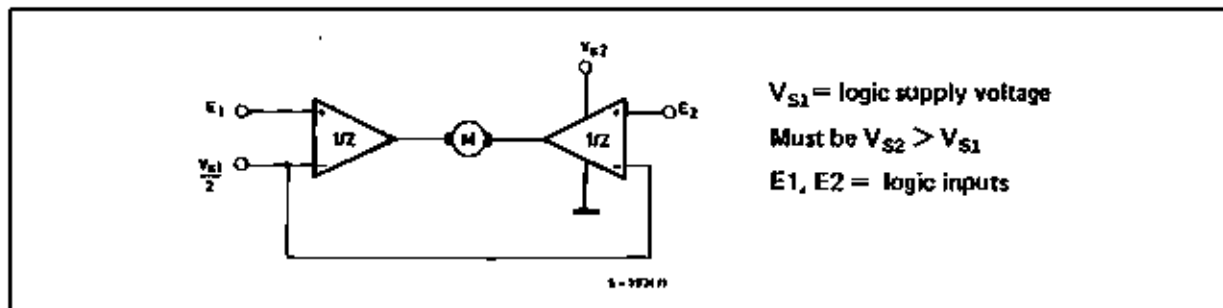

**Figure 10 :** Servocontrol for Compact-disc

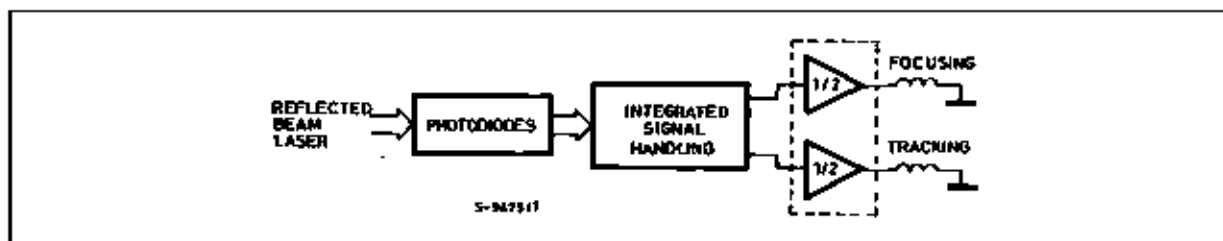

**Figure 11 :** Capstan Motor Control in Video Recorders

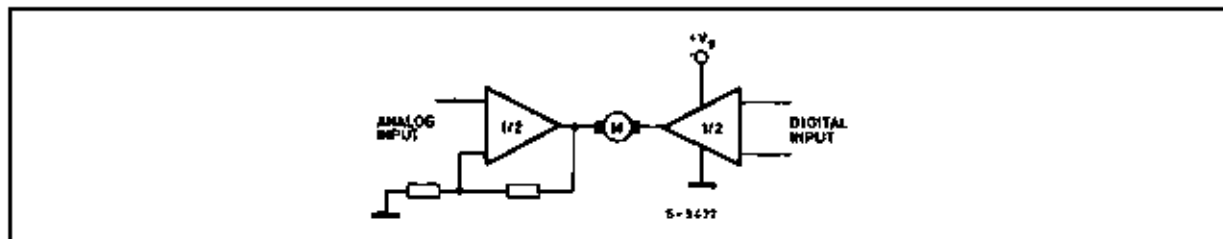
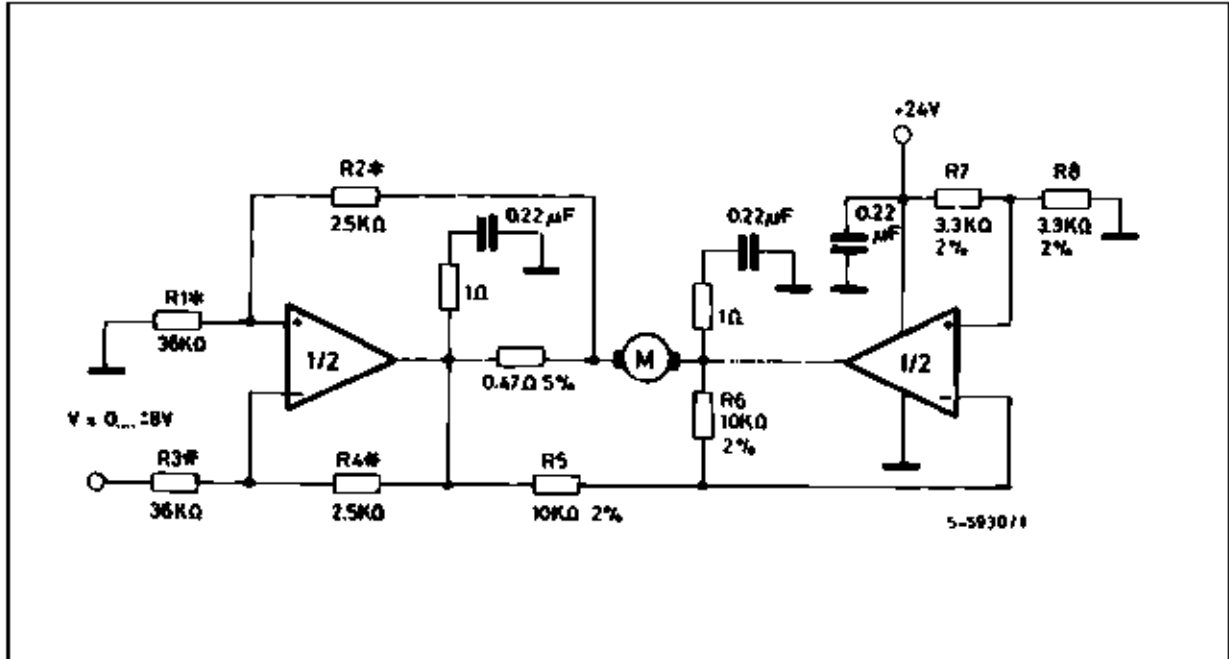

Figure 12 : Motor Current Control Circuit.



Note : The input voltage level is compatible with L291 (5-BIT D/A converter).

Figure 13 : Bidirectional Speed Control of DC Motors.

For circuit stability ensure that  $R_X > \frac{2R_3 \cdot R_1}{R_M}$  where  $R_M$  = internal resistance of motor.

The voltage available at the terminals of the motor is  $V_M = 2 \left( V_i \cdot \frac{V_s}{2} \right) + |R_o| \cdot I_M$  where  $|R_o| = \frac{2R \cdot R_1}{R_X}$  and  $I_M$  is the motor current.

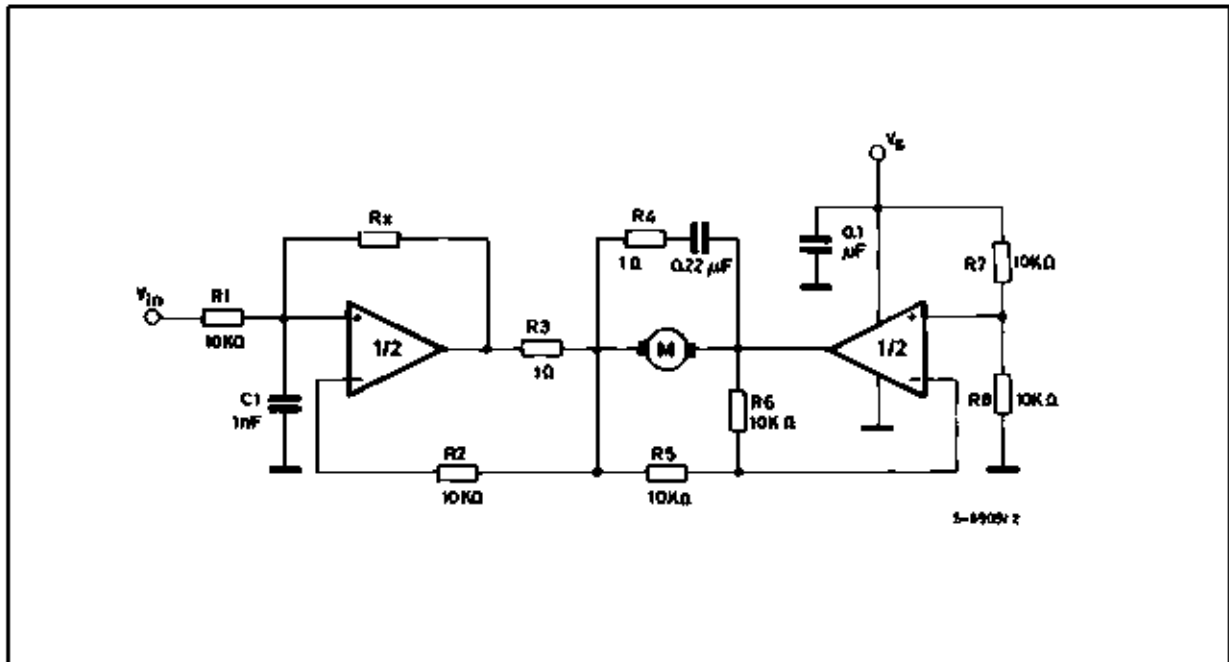

## POWERDIP 16 PACKAGE MECHANICAL DATA

DIM.	mm			inch		
	MIN.	TYP.	MAX.	MIN.	TYP.	MAX.
a1	0.51			0.020		
B	0.85		1.40	0.033		0.055
b		0.50			0.020	
b1	0.38		0.50	0.015		0.020
D			20.0			0.787
E		8.80			0.346	
e		2.54			0.100	
e3		17.78			0.700	
F			7.10			0.280
I			5.10			0.201
L		3.30			0.130	
Z			1.27			0.050

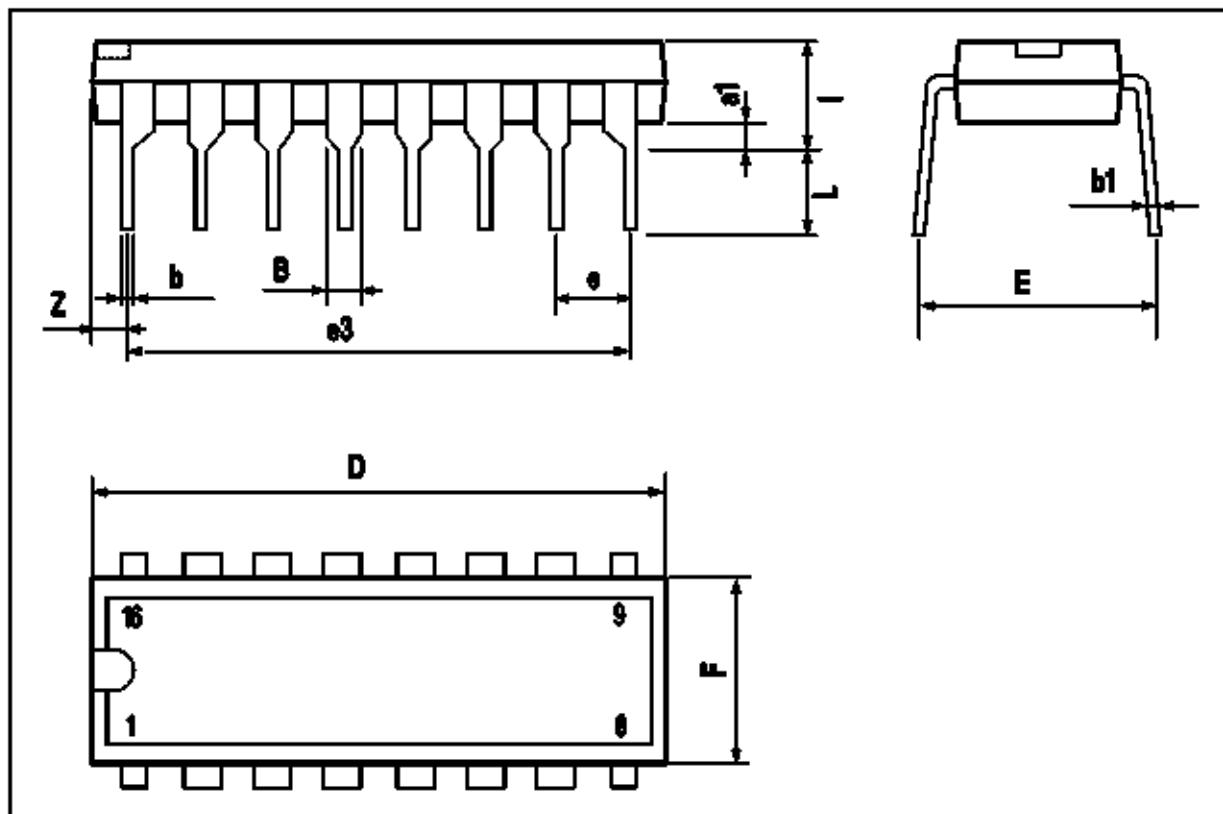

## MINIDIP PACKAGE MECHANICAL DATA

DIM.	mm			inch		
	MIN.	TYP.	MAX.	MIN.	TYP.	MAX.
A		3.32			0.131	
a1	0.51			0.020		
B	1.15		1.65	0.045		0.065
b	0.356		0.55	0.014		0.022
b1	0.204		0.304	0.008		0.012
D			10.92			0.430
E	7.95		9.75	0.313		0.384
e		2.54			0.100	
e3		7.62			0.300	
e4		7.62			0.300	
F			6.6			0.260
I			5.08			0.200
L	3.18		3.81	0.125		0.150
Z			1.52			0.060

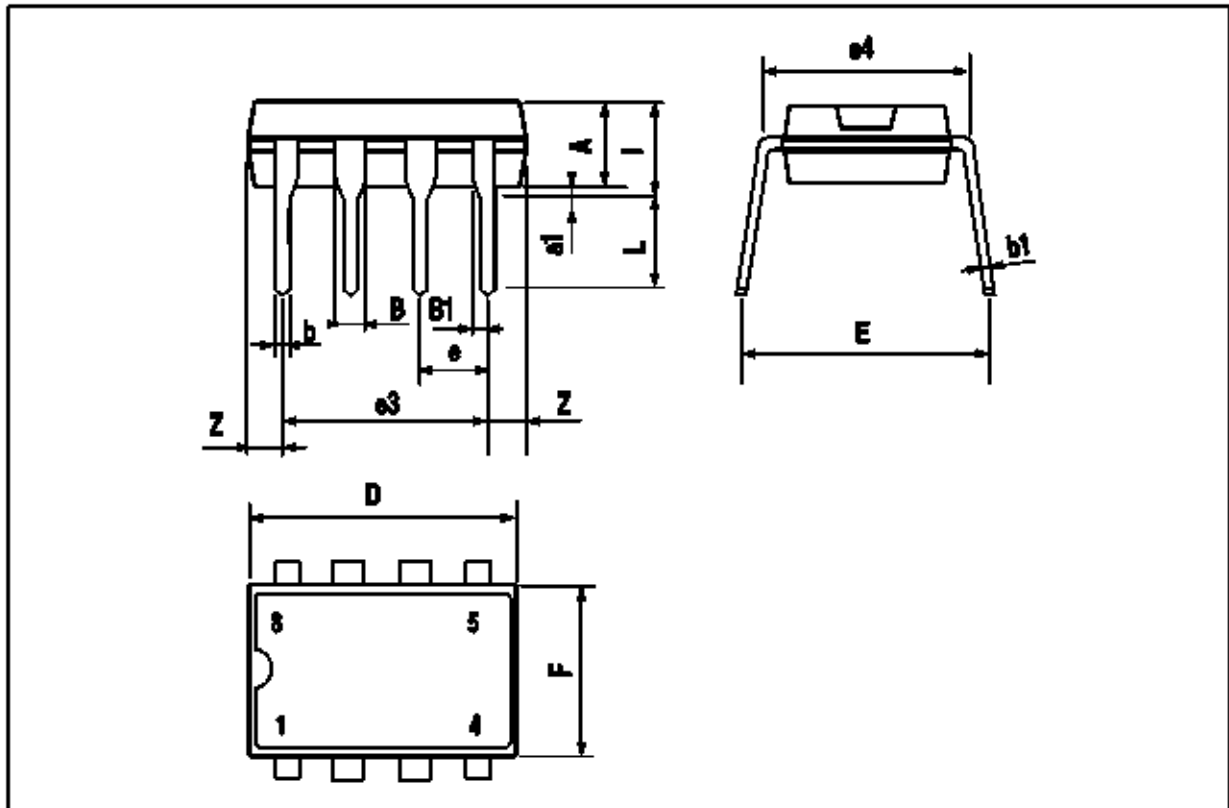



## SO16 NARROW PACKAGE MECHANICAL DATA

DIM.	mm			inch		
	MIN.	TYP.	MAX.	MIN.	TYP.	MAX.
A			1.75			0.069
a1	0.1		0.25	0.004		0.009
a2			1.6			0.063
b	0.35		0.46	0.014		0.018
b1	0.19		0.25	0.007		0.010
C		0.5			0.020	
c1	45° (typ.)					
D	9.8		10	0.386		0.394
E	5.8		6.2	0.228		0.244
e		1.27			0.050	
e3		8.89			0.350	
F	3.8		4.0	0.150		0.157
L	0.4		1.27	0.150		0.050
M			0.62			0.024
S	8° (max.)					

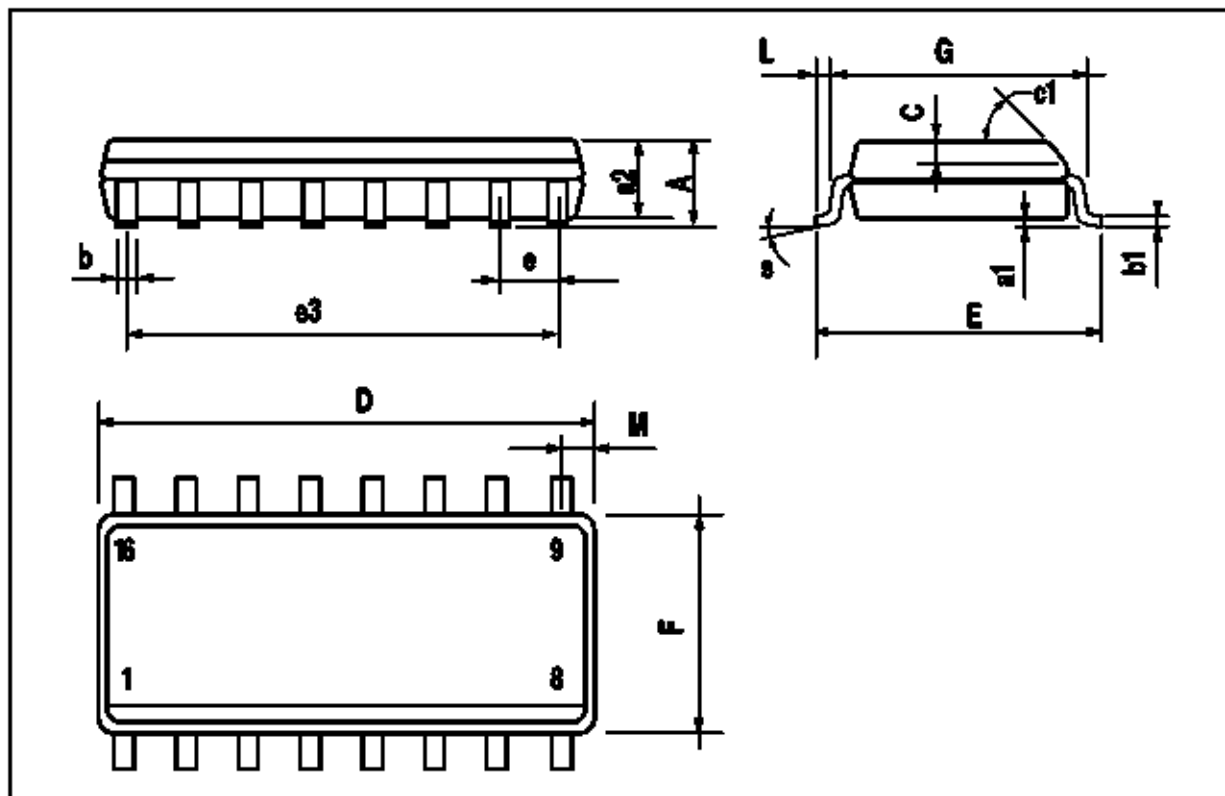

Information furnished is believed to be accurate and reliable. However, SGS-THOMSON Microelectronics assumes no responsibility for the consequences of use of such information nor for any infringement of patents or other rights of third parties which may result from its use. No license is granted by implication or otherwise under any patent or patent rights of SGS-THOMSON Microelectronics. Specifications mentioned in this publication are subject to change without notice. This publication supersedes and replaces all information previously supplied. SGS-THOMSON Microelectronics products are not authorized for use as critical components in life support devices or systems without express written approval of SGS-THOMSON Microelectronics.

© 1995 SGS-THOMSON Microelectronics - All Rights Reserved

SGS-THOMSON Microelectronics GROUP OF COMPANIES

Australia - Brazil - France - Germany - Hong Kong - Italy - Japan - Korea - Malaysia - Malta - Morocco - The Netherlands - Singapore - Spain - Sweden - Switzerland - Taiwan - Thailand - United Kingdom - U.S.A.