

1-CHIP DEFLECTION SYSTEM

The KA2133 consists of a vertical system including an output function and a horizontal system including an AFC function. It is for use in small size color TVs, B/W TV receivers and monitors.

FUNCTIONS

(Horizontal Section)

- SYNC separators
- Horizontal oscillators
- Horizontal predrivers
- Horizontal predrivers
- Horizontal AFCs
- Shunt regulators (Typ.: 6.7V)

(Vertical Section)

- Vertical oscillators
- Vertical predrivers
- Vertical output
- Flyback generators

FEATURES

- Low power consumption, direct deflection coil driving capability (Flyback voltage two times as high as supply voltage is supplied during flyback period only)
- Variable circuit of vertical retrace time on chip.

ORDERING INFORMATION

Device	Package	Operating Temperature
KA2133	16 DIP H/S	-20 ~ +75°C

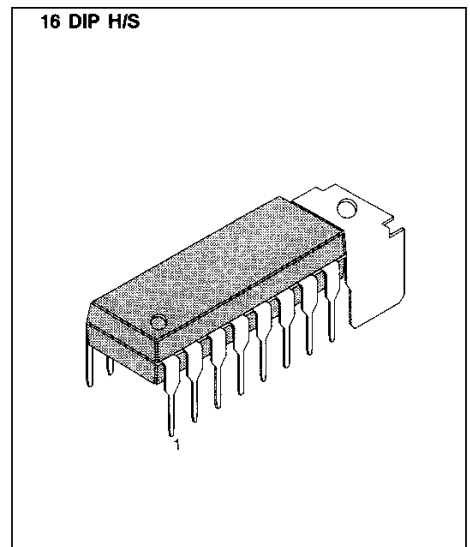

BLOCK DIAGRAM

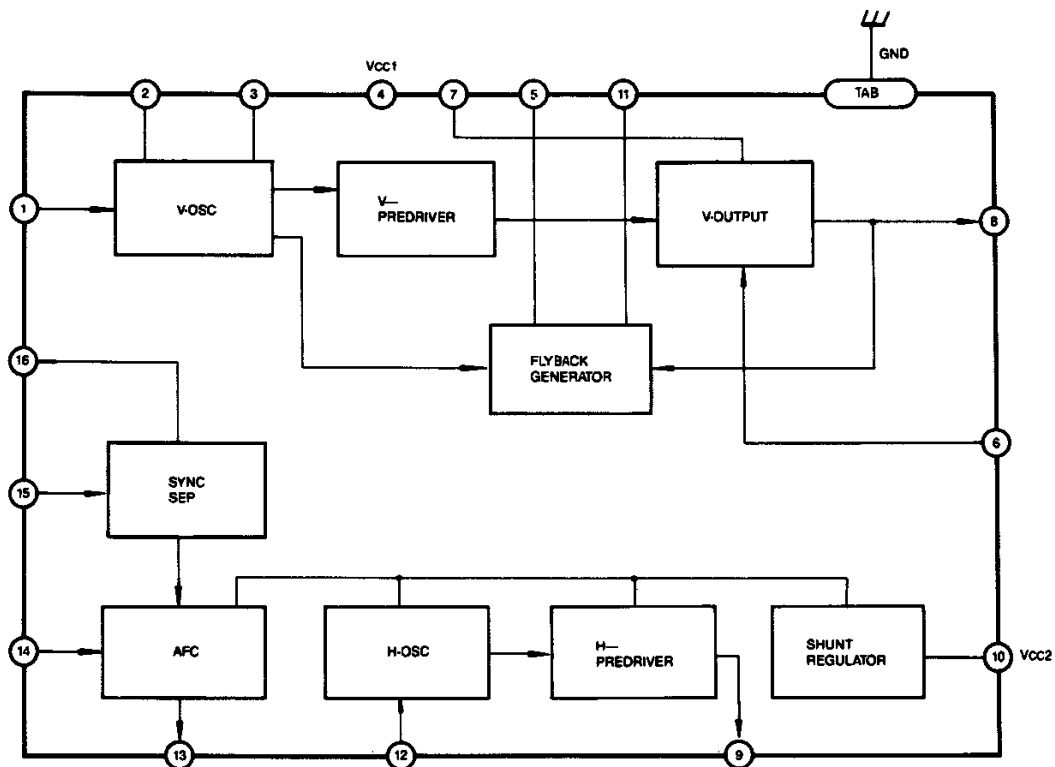

Fig. 1

ABSOLUTE MAXIMUM RATINGS ($T_a = 25^\circ\text{C}$)

Characteristic	Symbol	Value	Unit
Vertical Supply Voltage	V_{CC}	15	V
Horizontal Supply Current	I_{10}	30	mA
Vertical Output Current	I_b	-500 ~ +500	mA peak
Horizontal Output Current (Pulse)	I_g	15 ~ +5	mA
Flyback Generator Output Current	I_s	-500 ~ +500	mA peak
Power Dissipation	P_D	1.3	W
Operating Temperature	T_{OPR}	-20 ~ +75	$^\circ\text{C}$
Storage Temperature	T_{STG}	-40 ~ +150	$^\circ\text{C}$

RECOMMENDED OPERATING CONDITIONS ($T_a = 25^\circ\text{C}$)

Characteristic	Symbol	Min	Typ	Max	Unit
Vertical Supply Voltage	V_{CC}	9.6	12.0	14.4	V
Horizontal Supply Current	I_{10}	6.5	12	18	mA

ELECTRICAL CHARACTERISTICS ($V_{CC} = 12\text{V}$, $I_{10} = 12\text{mA}$, $T_a = 25^\circ\text{C}$)

Characteristic	Symbol	Test Conditions	Min	Typ	Max	Unit	Test Fig
Vertical Supply Current	$I_{CC} (1)$	$SW_A = 2$	—	85	100	mA	2
Vertical Supply Current	$I_{CC} (2)$	No Input Signal $SW_A = 2$	6	12	20	mA	2
Vertical Free Running Frequency	f_{VO}	$SW_A = 1$	55	60	65	Hz	2
Drift of Vertical Free-Running Frequency	$\Delta f_{VO}/V_{CC}$	$\Delta f_{VO} = 1f_{VO}(14.4\text{V}) - f_{VO}(9.6\text{V})$ $SW_A = 2$	—	0.8	2	Hz	2
	$\Delta f_{VO}/T_A$	$\Delta f_{VO} = 1f_{VO}(-20^\circ\text{C}) - f_{VO}(+70^\circ\text{C})$ $SW_A = 2$	—	1.5	2	Hz	2
Vertical Output Center Voltage	V_{MID}	$SW_A = 2$	5.3	5.8	6.3	V	2
Vertical Output Current	I_b	$SW_A = 2$	450	500	550	mA _{p-p}	2
Horizontal Supply Pin Voltage	V_{10}	$SW_B = 2$	6.2	6.7	7.2	V	2
Horizontal Free Running Frequency	f_{HO}	$I_{10} = 12\text{mA}$ $SW_B = 1$	15.0	15.75	16.5	KHz	2
Horizontal Output Pulse Width	t_{HPW}	$f_{HO} = 15.75\text{KHz}$ $SW_B = 2$	23	25	27	us	2
Horizontal Output Current	I_g	$SW_B = 2$	0.8	1.3	2.0	mA	2

TEST CIRCUIT

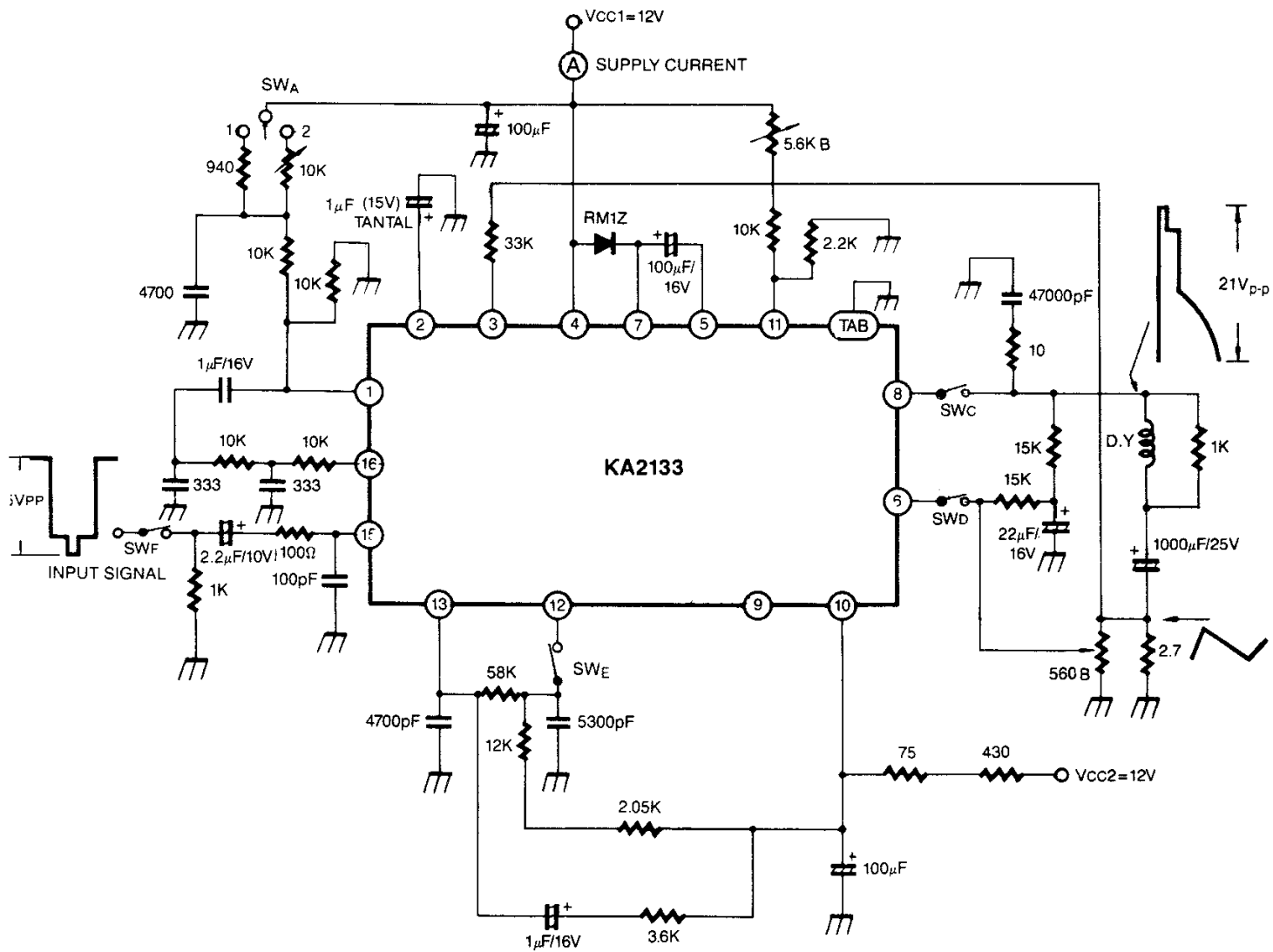

Fig. 2