

The LA7850 is a sync-deflection circuit IC dedicated to CRT display use. It can be connected to the LA7832,7833,7837,7838 (for vertical output use) to form a sync-deflection circuit that meets every requirement for CRT display use.

So far, ICs for color TV use have been applied to the sync-deflection circuit for CRT display use and general-purpose ICs such as one-shot multivibrator, inverter and a lot of transistors have been used to form the peripherals such as sync input interface, horizontal phase shifter. The LA7850 contains these peripherals on chip and adopts a stable circuit for horizontal oscillation from 15kHz to 100kHz aiming at improving the characteristics required for CRT display use.

### Features

- The horizontal oscillation frequency can be adjusted stably from 15kHz to 100kHz.
- The horizontal display can be shifted right/left.
- The horizontal/vertical sync input can be used intact regardless of the difference in pulse polarity and pulse width.
- The AFC feedback sawtooth wave can be obtained by simply applying a flyback pulse to the IC as a trigger pulse.
- Any duty of the horizontal pulse can be set.
- Good vertical linearity because DC bias at vertical output stage is subjected to sampling control within retrace time.

### On-chip Functions

#### [Horizontal Block]

- AFC
- Horizontal OSC
- X-ray protector
- Horizontal phase shift
- AFC sawtooth wave generator
- Horizontal pulse duty setting

#### [Vertical Block]

- Vertical OSC
- Vertical sawtooth wave generator
- Sampling type DC voltage control

### Maximum Ratings at $T_a = 25^\circ\text{C}$

Maximum Supply Voltage	$V_{10}, V_{20} \text{ max}$	14	unit
Allowable Power Dissipation	$P_d \text{ max}$ $T_a \leq 65^\circ\text{C}$	780	mW
Operating Temperature	$T_{opr}$	-20 to +85	$^\circ\text{C}$
Storage Temperature	$T_{stg}$	-55 to +125	$^\circ\text{C}$

### Package Dimensions

(unit : mm)  
3021B

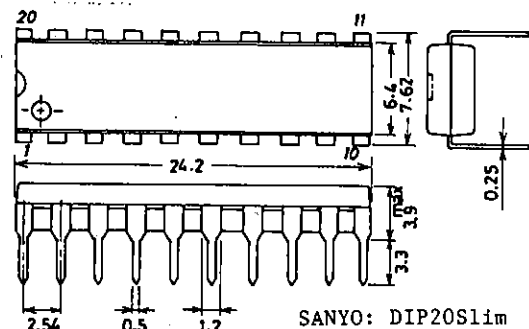

LA7850

Operating Conditions at Ta=25°C

			unit
Recommended Supply Voltage	V <sub>10</sub> , V <sub>20</sub>	12	V
Operating Voltage Range	V <sub>10</sub> , V <sub>20</sub>	9 to 13.5	V
Recommended Vertical Pulse Input Peak Value	V <sub>pulse</sub>	5	V <sub>p-p</sub>
Operating Vertical Pulse Input Peak Value Range	V <sub>pulse</sub>	2 to 6	V <sub>p-p</sub>
Recommended Horizontal Pulse Input Peak Value	H <sub>pulse</sub>	5	V <sub>p-p</sub>
Operating Horizontal Pulse Input Peak Value Range	H <sub>pulse</sub>	2 to 6	V <sub>p-p</sub>

Operating Characteristics at Ta=25°C, V<sub>10</sub>, V<sub>20</sub>=12V

			min	typ	max	unit
V <sub>CC10</sub> Current Dissipation	I <sub>10</sub>		12		30	mA
V <sub>CC20</sub> Current Dissipation	I <sub>20</sub>		5		12	mA
Vertical Frequency Pull-in Range	V <sub>p in</sub>	Vertical sync 60Hz	10.0		12.0	Hz
Vertical Free-running Frequency	f <sub>v</sub>	f <sub>v</sub> center 55 Hz	50		60	Hz
Increased/Reduced Voltage	Δf <sub>vv</sub>	V <sub>20</sub> =12±1V, 55Hz at 12V	-0.1		0.1	Hz
Characteristic of Vertical Frequency						
Midpoint Control Threshold Level			3.8		4.4	V
Vertical OSC Start Voltage	f <sub>vst</sub>				4.0	V
Temperature Characteristic of Vertical Frequency		Ta=-10 to +60°C	-0.028		0.028	Hz/°C
Vertical Driver Amplification Factor	G <sub>v</sub>		12		18	dB
Horizontal AFC DC Loop Gain	I <sub>AFC</sub>		±0.85		±1.6	mA
Horizontal Free-running Frequency	f <sub>H</sub>	f <sub>H</sub> center 15.734kHz	-750		750	Hz
Horizontal OSC Start Voltage	f <sub>Hst</sub>				4.0	V
Increased/Reduced Voltage	Δf <sub>Hv</sub>	V <sub>10</sub> =12±1V, 15.734kHz at 12V	-50		50	Hz
Characteristic of Horizontal Frequency						
Horizontal OSC Warm-up Drift	Δf <sub>H</sub>	5s. to 30min. after application of power	-50		50	Hz
Temperature Characteristic of Horizontal Frequency		Ta=-10 to +60°C	-2.9		2.9	Hz/°C
Horizontal Output Drive Current	I <sub>12</sub>		6.0		12.0	mA
Increased/Reduced Voltage		V <sub>10</sub> =12±1V	-0.5		0.5	%/V
Characteristic of Phase Shifter Delay Time						
Temperature Characteristic of Phase Shifter Delay Time		Ta=-10 to +60°C	-0.1		0.1	%/°C
Increased/Reduced Voltage		V <sub>10</sub> =12±1V	-1.0		1.0	%/V
Characteristic of Phase Shifter Delay Time						
Temperature Characteristic of Phase Shifter Pulse Width		Ta=-10 to +60°C	-0.13		0.13	%/°C
AFC Phase Comparison Center Time		15.734kHz after F.B.P. input	9.9		11.5	μs
Increased/Reduced Voltage		V <sub>10</sub> =12±1V	-1.5		1.5	%/V
Characteristic of AFC Phase Comparison Center Time						
Temperature Characteristic of AFC Comparison Center Time		Ta=-10 to +60°C	-0.2		0.2	%/°C
Comparison Waveform Generating Input Operation Voltage	V <sub>4</sub>		0.6		0.9	V
Pin 13 Voltage at Hold-down Operation Start	V <sub>13</sub>		0.5		0.8	V

# LA7850

## Equivalent Circuit Block Diagram

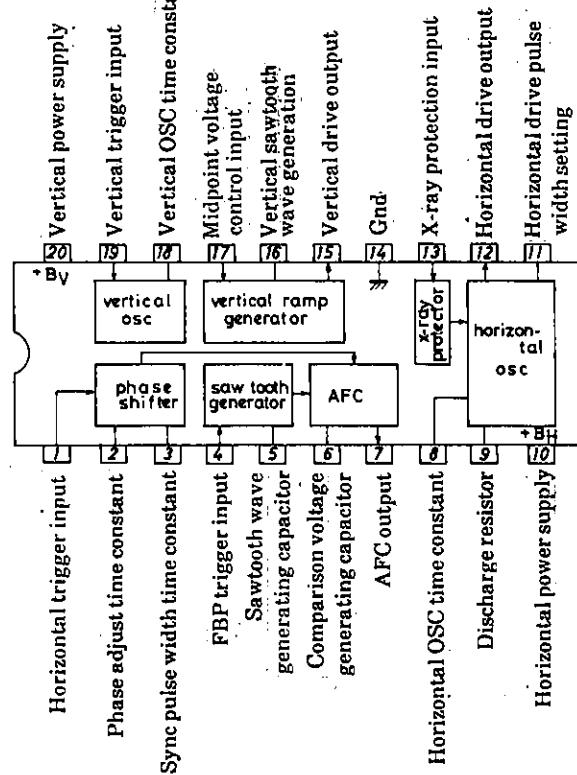

Sample Application Circuit: 14" Color Monitor/ $f_v = 60\text{Hz}$ ,  $f_H = 15.734\text{kHz}$

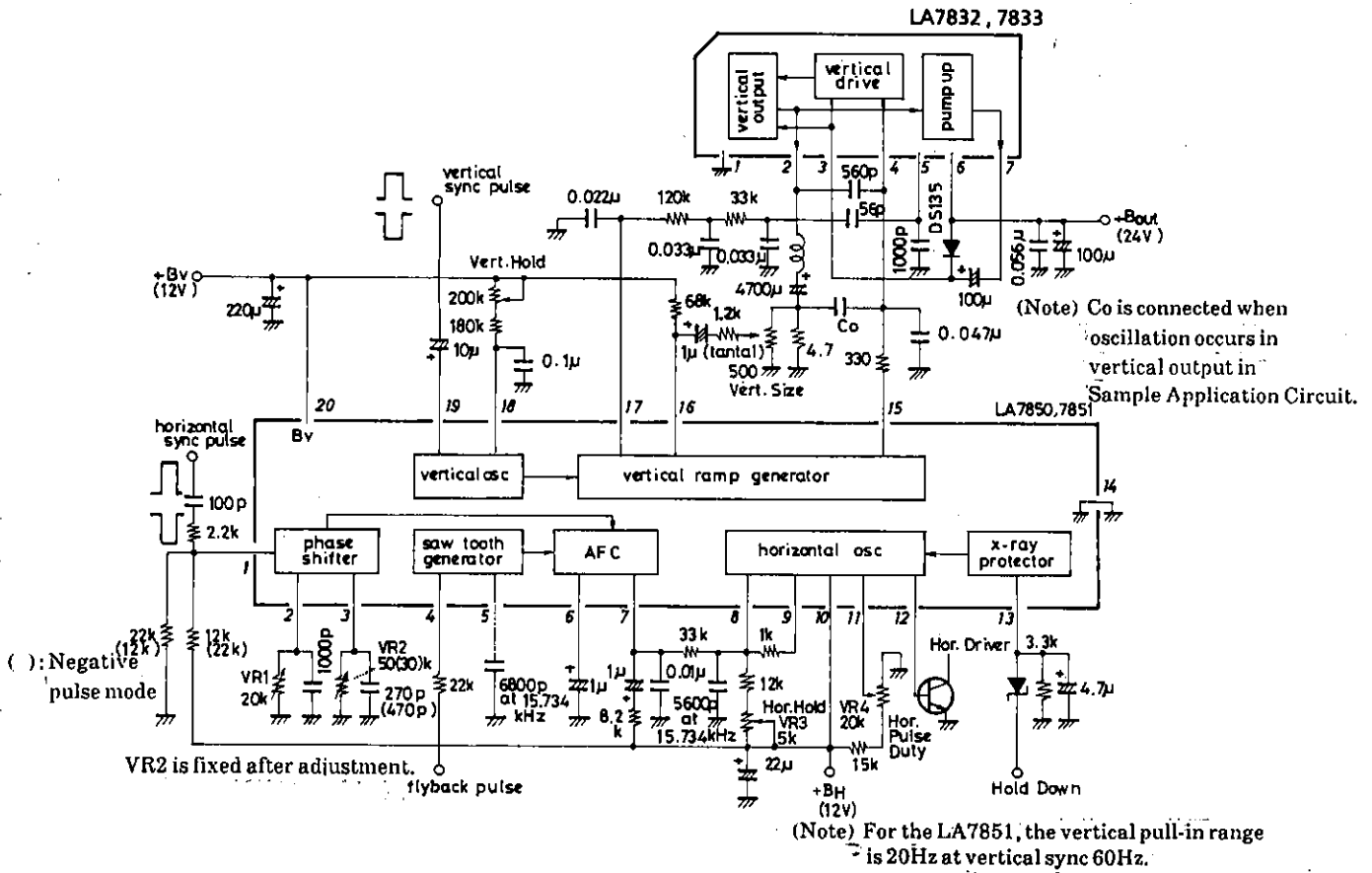

Unit (resistance:  $\Omega$ , capacitance: F)

# LA7850

Sample Application Circuit: 14" Color Monitor/ $f_V = 60\text{Hz}$ ,  $f_H = 15.734\text{kHz}$

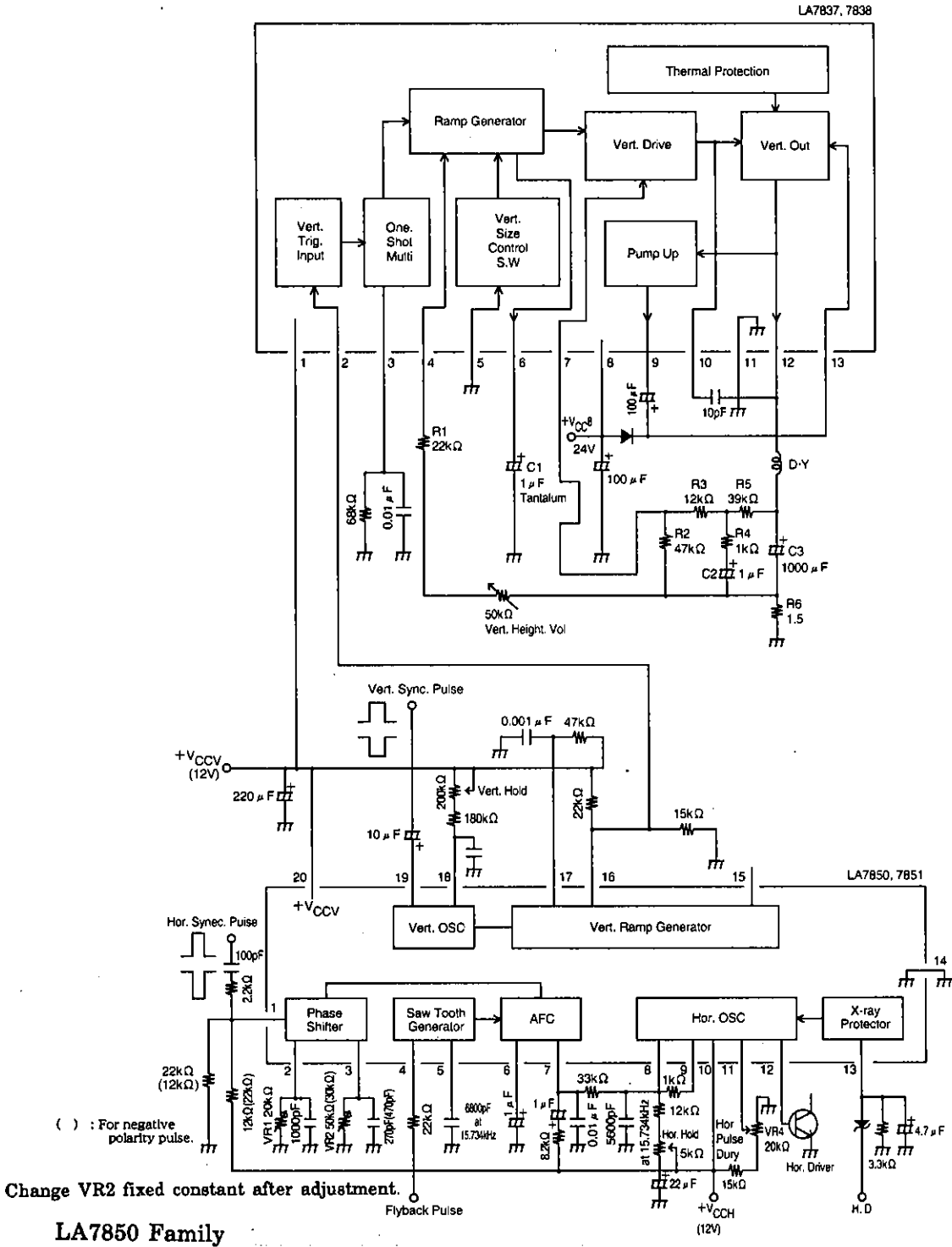

Type No.	LA7850	LA7851	LA7852	LA7853
Package	DIP-20S (Slim Type)	DIP-20S (Slim Type)	DIP-22S (Shrink Type)	DIP-22S (Shrink Type)
Differences in characteristics	Vertical pull-in range ( $f_V = 60\text{Hz}$ )	10Hz	20Hz	10Hz
	GND pin	Hor./vert. common	Hor./vert. common	Hor./vert. separated

- No products described or contained herein are intended for use in surgical implants, life-support systems, aerospace equipment, nuclear power control systems, vehicles, disaster/crime-prevention equipment and the like, the failure of which may directly or indirectly cause injury, death or property loss.
- Anyone purchasing any products described or contained herein for an above-mentioned use shall:
  - ① Accept full responsibility and indemnify and defend SANYO ELECTRIC CO., LTD., its affiliates, subsidiaries and distributors and all their officers and employees, jointly and severally, against any and all claims and litigation and all damages, cost and expenses associated with such use;
  - ② Not impose any responsibility for any fault or negligence which may be cited in any such claim or litigation on SANYO ELECTRIC CO., LTD., its affiliates, subsidiaries and distributors or any of their officers and employees jointly or severally.
- Information (including circuit diagrams and circuit parameters) herein is for example only; it is not guaranteed for volume production. SANYO believes information herein is accurate and reliable, but no guarantees are made or implied regarding its use or any infringements of intellectual property rights or other rights of third parties.

This catalog provides information as of **June , 1996** . Specifications and information herein are subject to change without notice.