

VERTICAL DEFLECTION BOOSTER

- POWER AMPLIFIER
- FLYBACK GENERATOR
- THERMAL PROTECTION
- OUTPUT CURRENT UP TO 2.0A_{PP}
- FLYBACK VOLTAGE UP TO 90V (on Pin 5)
- SUITABLE FOR DC COUPLING APPLICATION

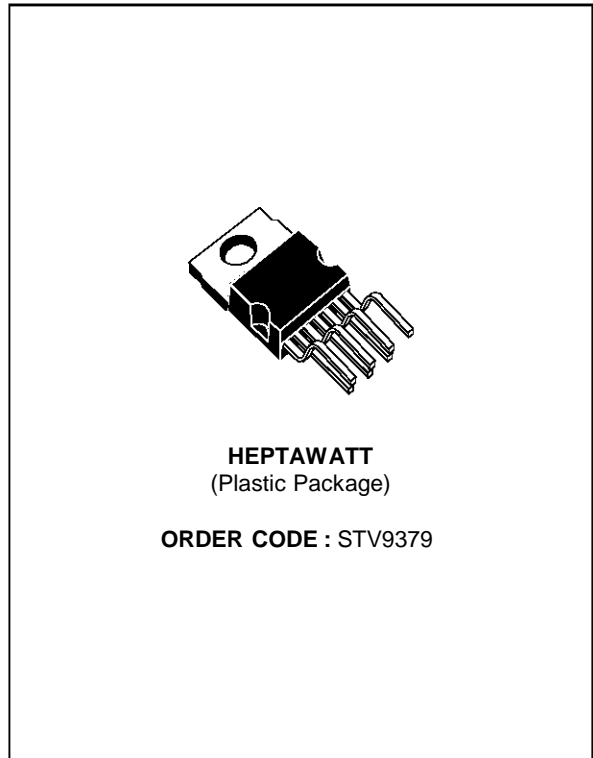

DESCRIPTION

Designed for monitors and high performance TVs, the STV9379 vertical deflection booster delivers flyback voltages up to 90V.

The STV9379 operates with supplies up to 42V and provides up to 2A_{pp} output current to drive the yoke.

The STV9379 is offered in HEPTAWATT package.

PIN CONNECTIONS

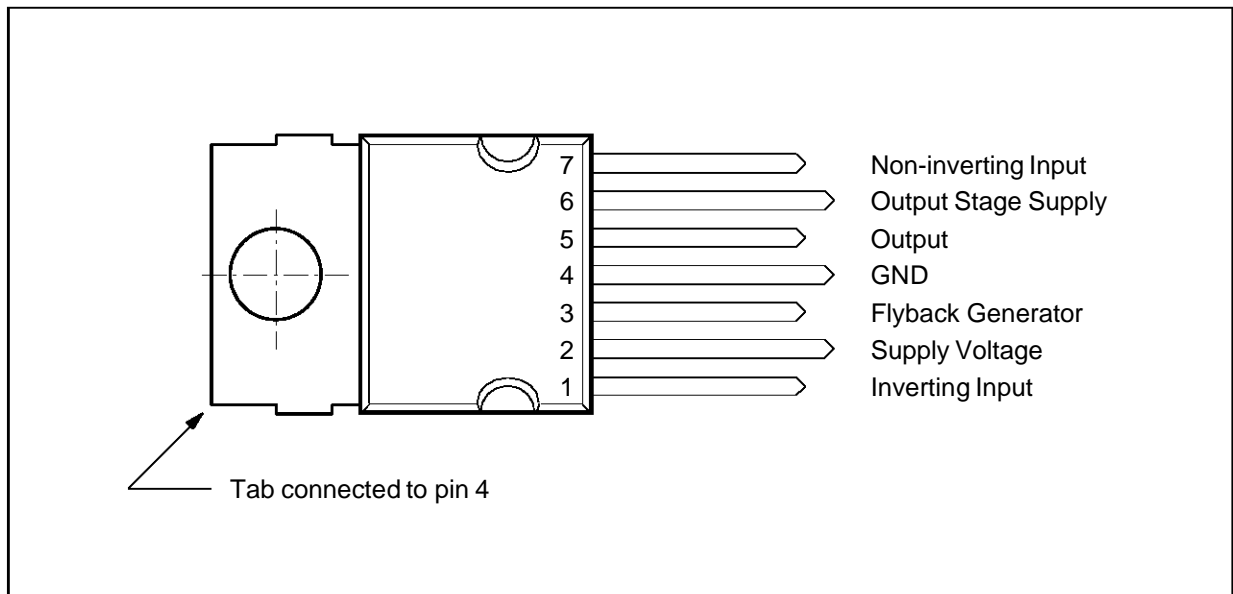

9379-01.EPS

BLOCK DIAGRAM

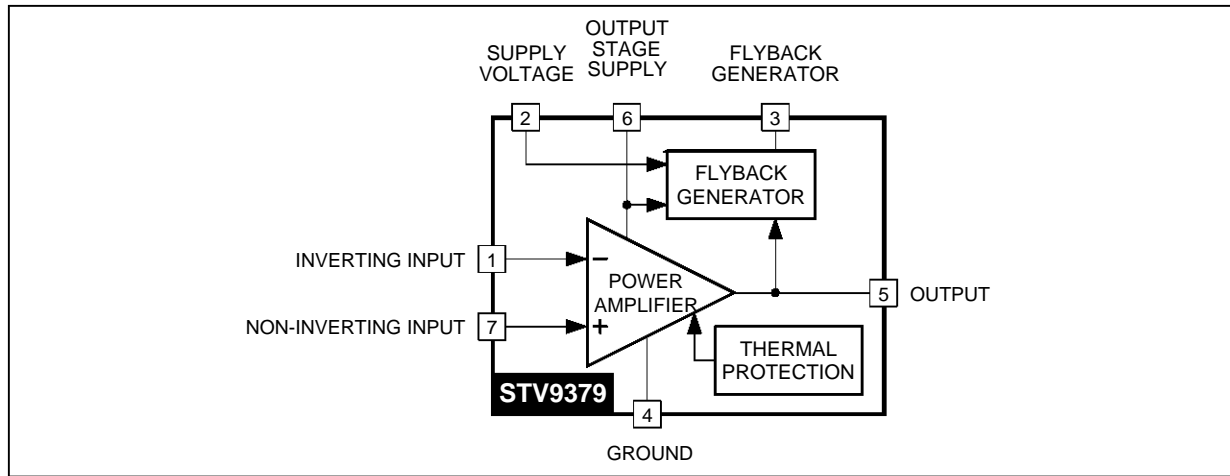

9379-02.EPS

ABSOLUTE MAXIMUM RATINGS

Symbol	Parameter	Value	Unit
V_S	Supply Voltage (Pin 2) (see note 1)	50	V
V_6	Flyback Peak Voltage (Pin 6) (see note 1)	100	V
V_1, V_7	Amplifier Input Voltage (Pins 1-7) (see note 1)	- 0.3, + V_S	V
I_O	Maximum Output Peak Current (see notes 2 and 3)	1.5	A
I_3	Maximum Sink Current (first part of flyback) ($t < 1$ ms)	1.5	A
I_3	Maximum Source Current ($t < 1$ ms)	1.5	A
V_{ESD}	Electrostatic Handling for all pins (see note 4)	300	V
T_{oper}	Operating Ambient Temperature	- 20, + 75	°C
T_{stg}	Storage Temperature	- 40, + 150	°C
T_j	Junction Temperature	+150	°C

9379-01.TBL

- Notes :**
1. Versus GND.
 2. The output current can reach 4A peak for $t \leq 10\mu s$ (up to 120Hz).
 3. Provided SOAR is respected (see Figures 1 and 2).
 4. Equivalent to discharging a 200pF capacitor through a 0Ω series resistor.

THERMAL DATA

Symbol	Parameter	Value	Unit
$R_{th(j-c)}$	Junction-case Thermal Resistance	Max. 3	°C/W
T_t	Temperature for Thermal Shutdown	150	°C
ΔT_t	Hysteresis on T_t	10	°C
T_{jr}	Recommended Max. Junction Temperature	120	°C

9379-02.TBL

ELECTRICAL CHARACTERISTICS

($V_S = 42V$, $T_A = 25^\circ C$, unless otherwise specified)

Symbol	Parameter	Test Conditions	Min.	Typ.	Max.	Unit
V_S	Operating Supply Voltage Range		10		42	V
I_2	Pin 2 Quiescent Current	$I_3 = 0, I_5 = 0$		10	20	mA
I_6	Pin 6 Quiescent Current	$I_3 = 0, I_5 = 0$	5	10	30	mA
I_O	Max. Peak Output Current				1	A
I_1	Amplifier Bias Current	$V_1 = 25V, V_7 = 26V$		- 0.15	- 1	μA
I_7	Amplifier Bias Current	$V_1 = 26V, V_7 = 25V$		- 0.15	- 1	μA
V_{IO}	Offset Voltage				7	mV
$\Delta V_{IO}/dt$	Offset Drift versus Temperature			- 10		$\mu V/^\circ C$
GV	Voltage Gain		80			dB
V_{5L}	Output Saturation Voltage to GND (Pin 4)	$I_5 = 1A$		1	1.5	V
V_{5H}	Output Saturation Voltage to Supply (Pin 6)	$I_5 = -1A$		1.6	2.1	V
V_{D5-6}	Diode Forward Voltage between Pins 5-6	$I_5 = 1A$		1.5	2	V
V_{D3-2}	Diode Forward Voltage between Pins 3-2	$I_3 = 1A$		1.5	2	V
V_{3L}	Saturation Voltage on Pin 3	$I_3 = 20mA$		0.8	1.2	V
V_{3SH}	Saturation Voltage to Pin 2 (2nd part of flyback)	$I_3 = -1A$		2.1	2.9	V

9379-03.TBL

APPLICATION CIRCUITS
AC COUPLING

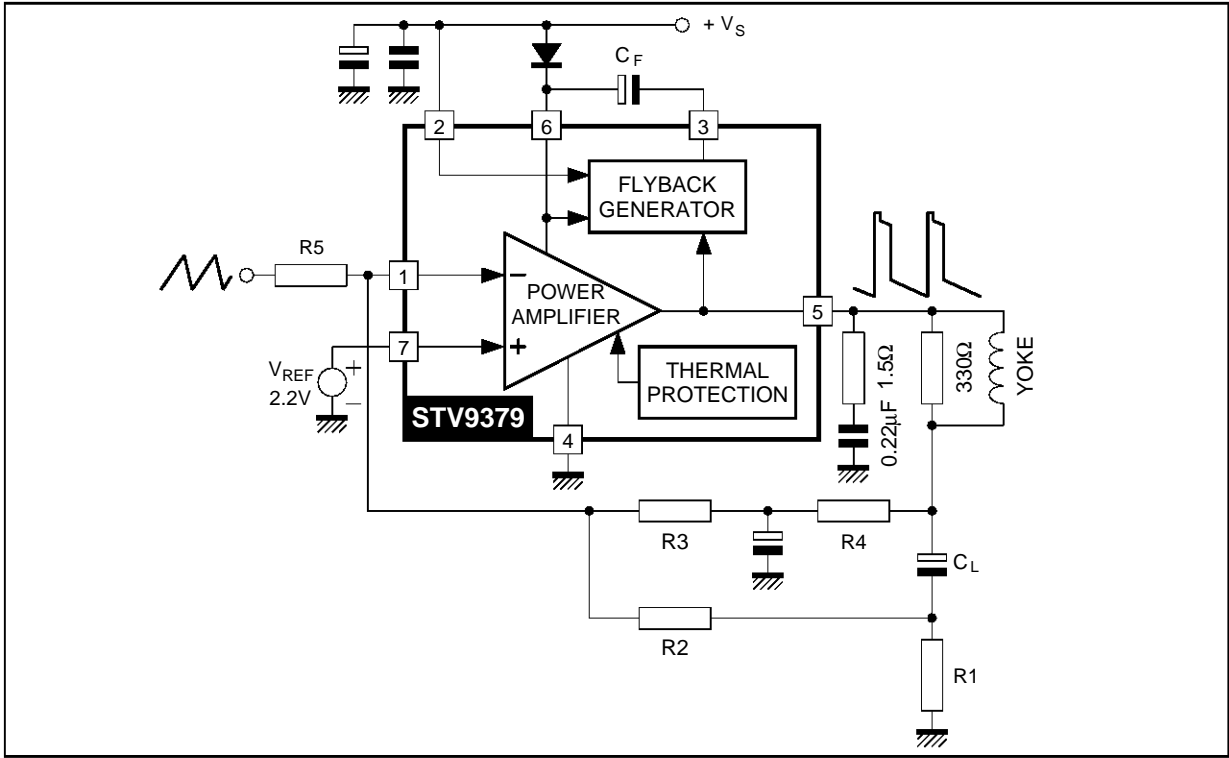

9379-03.EPS

APPLICATION CIRCUITS (continued)
DC COUPLING

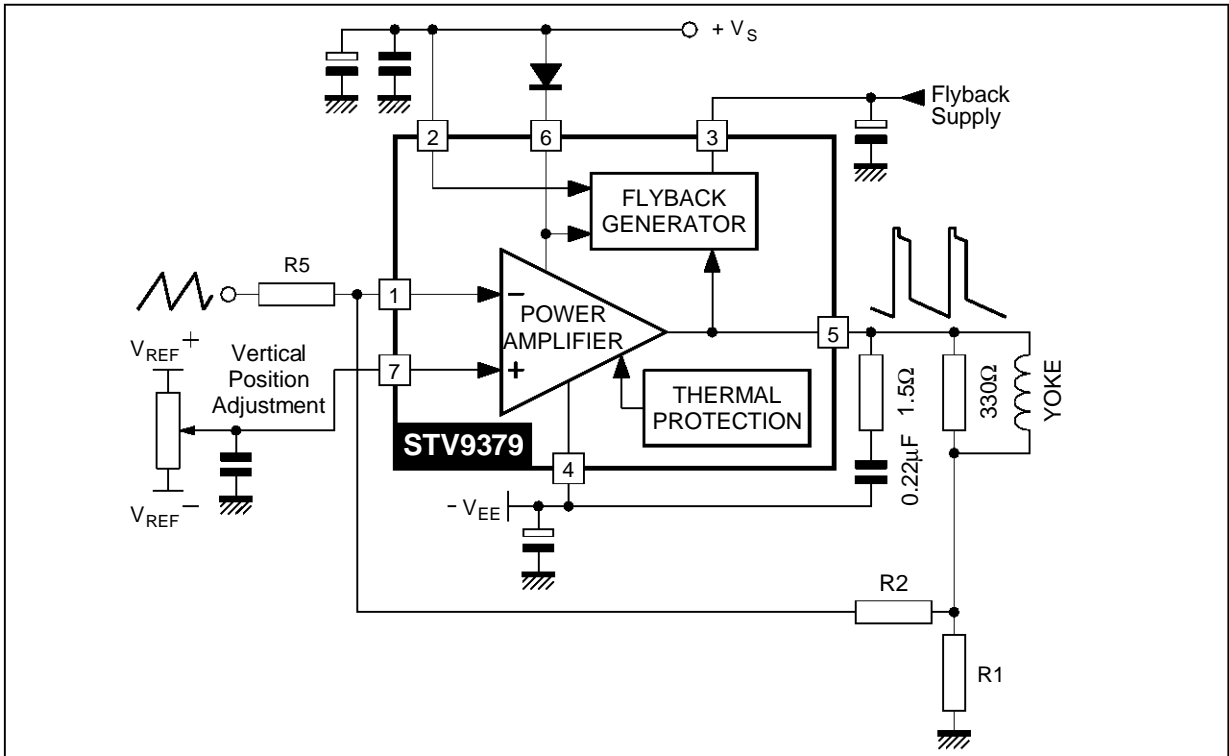

9379-04.EPS

Figure 1 : Output Transistors SOA
(for secondary breakdown)

Figure 2 : Secondary Breakdown Temperature
Derating Curve
(ISB = secondary breakdown current)

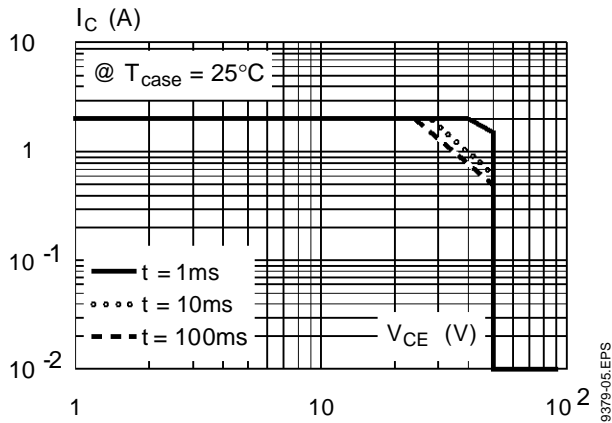

9379-05.EPS

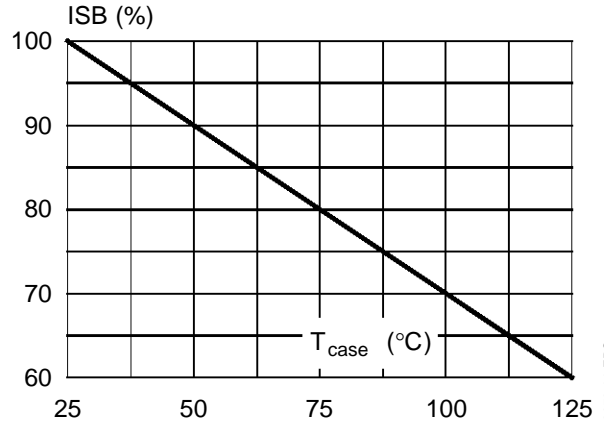

9379-06.EPS

PACKAGE MECHANICAL DATA : 7 PINS - PLASTIC HEPTAWATT

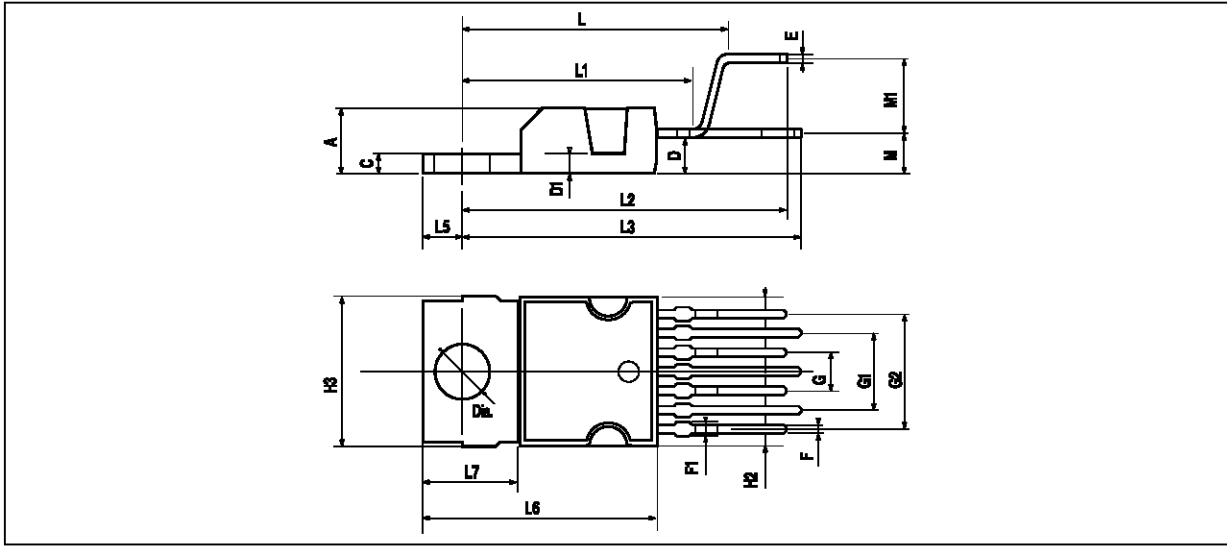

PM-HEPTV.EPS

Dimensions	Millimeters			Inches		
	Min.	Typ.	Max.	Min.	Typ.	Max.
A			4.8			0.189
C			1.37			0.054
D	2.4		2.8	0.094		0.110
D1	1.2		1.35	0.047		0.053
E	0.35		0.55	0.014		0.022
F	0.6		0.8	0.024		0.031
F1			0.9			0.035
G	2.41	2.54	2.67	0.095	0.100	0.105
G1	4.91	5.08	5.21	0.193	0.200	0.205
G2	7.49	7.62	7.8	0.295	0.300	0.307
H2			10.4			0.409
H3	10.05		10.4	0.396		0.409
L		16.97			0.668	
L1		14.92			0.587	
L2		21.54			0.848	
L3		22.62			0.891	
L5	2.6		3	0.102		0.118
L6	15.1		15.8	0.594		0.622
L7	6		6.6	0.236		0.260
M		2.8			0.110	
M1		5.08			0.200	
Dia.	3.65		3.85	0.144		0.152

HEPTV.TBL

Information furnished is believed to be accurate and reliable. However, SGS-THOMSON Microelectronics assumes no responsibility for the consequences of use of such information nor for any infringement of patents or other rights of third parties which may result from its use. No licence is granted by implication or otherwise under any patent or patent rights of SGS-THOMSON Microelectronics. Specifications mentioned in this publication are subject to change without notice. This publication supersedes and replaces all information previously supplied. SGS-THOMSON Microelectronics products are not authorized for use as critical components in life support devices or systems without express written approval of SGS-THOMSON Microelectronics.

© 1996 SGS-THOMSON Microelectronics - All Rights Reserved

Purchase of I^2C Components of SGS-THOMSON Microelectronics, conveys a license under the Philips I^2C Patent. Rights to use these components in a I^2C system, is granted provided that the system conforms to the I^2C Standard Specifications as defined by Philips.

SGS-THOMSON Microelectronics GROUP OF COMPANIES

Australia - Brazil - Canada - China - France - Germany - Hong Kong - Italy - Japan - Korea - Malaysia - Malta - Morocco
The Netherlands - Singapore - Spain - Sweden - Switzerland - Taiwan - Thailand - United Kingdom - U.S.A.