

TOSHIBA BIPOLAR LINEAR INTEGRATED CIRCUIT SILICON MONOLITHIC

# TA8759BN

## VIDEO CHROMA AND SYNC. SIGNAL PROCESSING IC FOR PAL / NTSC / SECAM SYSTEM COLOR TELEVISION

The TA8759BN is an PAL/NTSC/SECAM video /chroma / deflection sub system with the teletext interface circuit. The TA8759BN includes all of the functions required to realize a multi-color CTV in conjunction with a PIF/SIF IC, in a 64 leads shrink type dual-in-line plastic package.

### FUNCTIONS

- Realized a full automatic multi-color processing in conjunction with the TA8615N system switch, with minimal external components.
- Forced system selection.
- Automatic system change by a sub-carrier detection.
- The mode change output can be used for switching the external components or circuits.
- RGB interface with high switching speed, a half tone control and an independent contrast control.

### FEATURES

#### Video stage

- DC controlled 2'nd order differential picture sharpness.
- Contrast control with Uni-color control.
- Brightness control with pedestal clamp.
- Internal vertical blanking.

#### Chroma stage

- ACC circuit.
- Color control / Uni-color control.
- RGB primary color demodulator outputs.
- Adjustment free APC circuit.
- Tint control.
- PAL / NTSC / SECAM automatic system detection.
- Forced system selection / Automatic sub-carrier detection and switching.

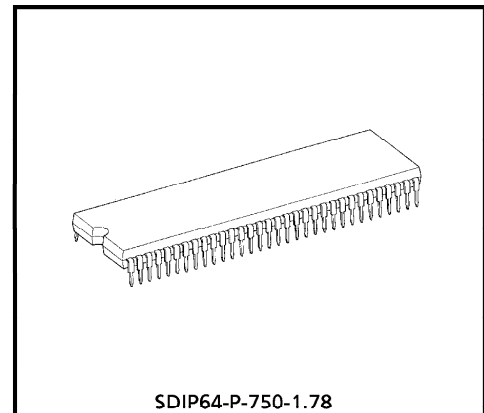

SDIP64-P-750-1.78

Weight : 8.85g (Typ.)

961001EBA2

- TOSHIBA is continually working to improve the quality and the reliability of its products. Nevertheless, semiconductor devices in general can malfunction or fail due to their inherent electrical sensitivity and vulnerability to physical stress. It is the responsibility of the buyer, when utilizing TOSHIBA products, to observe standards of safety, and to avoid situations in which a malfunction or failure of a TOSHIBA product could cause loss of human life, bodily injury or damage to property. In developing your designs, please ensure that TOSHIBA products are used within specified operating ranges as set forth in the most recent products specifications. Also, please keep in mind the precautions and conditions set forth in the TOSHIBA Semiconductor Reliability Handbook.
- The products described in this document are subject to foreign exchange and foreign trade control laws.
- The information contained herein is presented only as a guide for the applications of our products. No responsibility is assumed by TOSHIBA CORPORATION for any infringements of intellectual property or other rights of the third parties which may result from its use. No license is granted by implication or otherwise under any intellectual property or other rights of TOSHIBA CORPORATION or others.
- The information contained herein is subject to change without notice.

**Deflection stage**

- Excellent sync. separator performance.
- Adjustment free H/V oscillator by a count down system.
- Stable Vertical Sync.
- Saw tooth type horizontal AFC.
- Horizontal pre-driver.
- X-ray protector.
- Vertical NFB amplifier.
- 50Hz / 60Hz Automatic detection.

**Teletext interface stage**

- RGB inputs.
- TV / RGB switch.
- Text contrast control.
- Half tone control.

BLOCK DIAGRAM

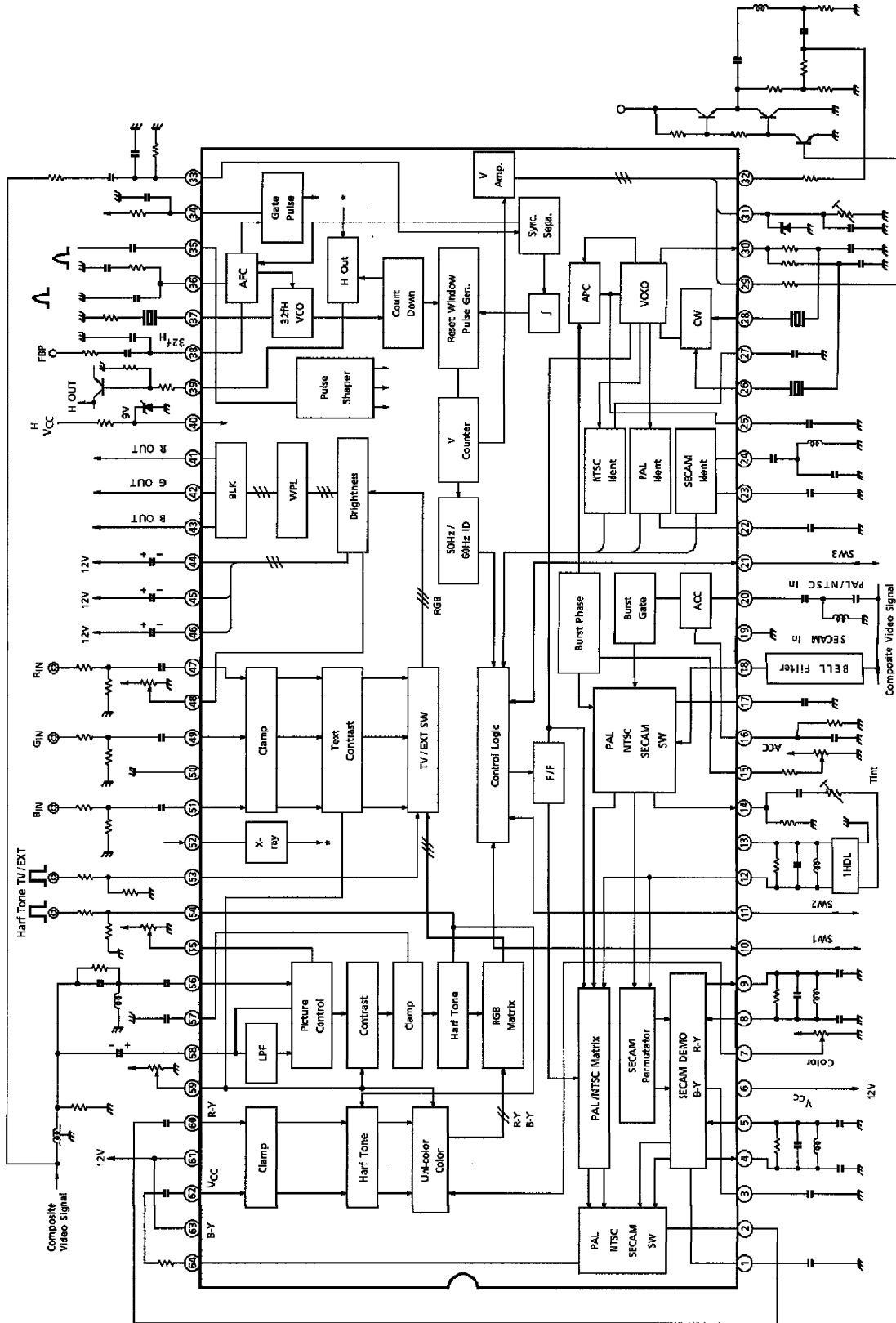

TA8759BN - 3

**TERMINAL FUNCTION**

Terminal list

PIN No.	FUNCTION	PIN No.	FUNCTION	PIN No.	FUNCTION
1	SECAM B-Y De-Emphasis	23	SECAM Ident	45	G Clamp
2	R-Y Out	24	SECAM Reference	46	B Clamp
3	SECAM R-Y De-Emphasis	25	APC Filter	47	External R Input
4	SECAM B-Y Det	26	3.58X'tal	48	Brightness Control
5		27	NTSC Ident	49	External G Input
6	VCC	28	4.43X'tal	50	GND
7	Color Control	29	Vertical Drive	51	External B Input
8	SECAM R-Y Det	30	VCXO	52	X-ray
9		31	Vertical Ramp	53	TV / External SW
10	SW1	32	Vertical NFB Input	54	Half Tone
11	SW2	33	Sync. Separation Input	55	Picture Sharpness
12	Delay Line Input	34	Gate Pulse Filter	56	Differential Signal Input
13	Bias	35	Horizontal BLK Input	57	Clamp
14	Delay Line Drive	36	AFC Filter	58	Video Input
15	Tint Control	37	VCO	59	Contrast Control
16	ACC Filter	38	Horizontal AFC Pulse Input	60	R-Y Input
17	DC Feed Back	39	Horizontal Output	61	VCC
18	SECAM Input	40	Horizontal VCC	62	B-Y Input
19	GND	41	R Output	63	VCC
20	PAL/NTSC Input	42	G Output	64	B-Y Output
21	SW3	43	B Output		
22	PAL Ident	44	R Clamp		

TERMINAL FUNCTION

PIN No.	PIN NAME	FUNCTION	INTERFACE CIRCUIT
1 3	SECAM De-emphasis	Connect a capacitor to GND for SECAM De-emphasis. Pin 1 : B-Y Pin 3 : R-Y	
2 64	Color Differential Signal Output	Pin 2 : R-Y Pin 64 : B-Y Load resistor of 8.2kΩ is connected to GND.	
4 9	SECAM Detector	A tuned tank circuit for SECAM detector is connected.	
5 8	SECAM Detector	A tuned tank circuit for SECAM detector is connected.	

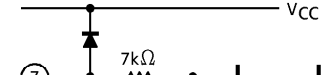
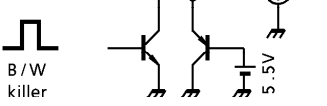
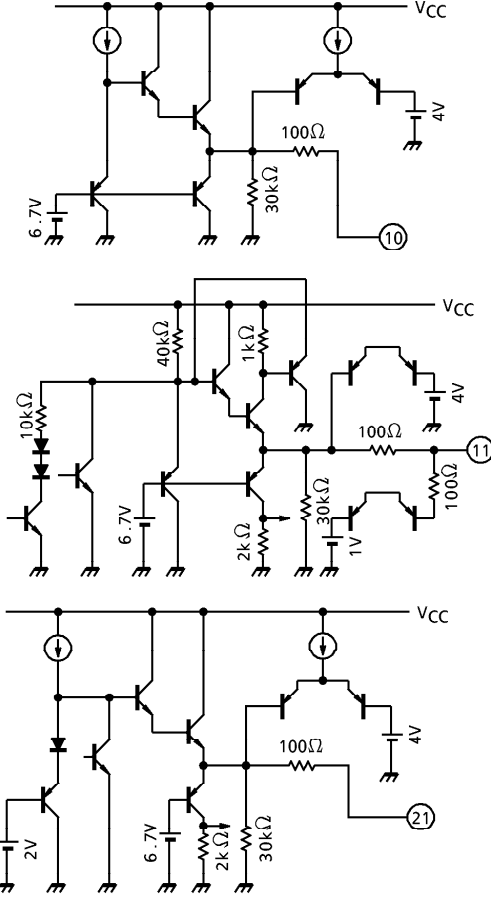
PIN No.	PIN NAME	FUNCTION	INTERFACE CIRCUIT
6	V <sub>CC</sub>	The typical supply voltage is 12.0V. Bypass capacitance is connected to the pin 19.	
7	Color Control	Color saturation increases when the terminal voltage of pin 7 increases. When the color killer circuit operates, the terminal voltage of pin 7 turns to low.	
10 11 21	System Logic I/O	<p>This terminal is an output of System Identification Logic circuit and also an input of Manual Select Mode. Pin 10 : SW1 Pin 11 : SW2 Pin 21 : SW3 See logic table.</p> <p>NTSC Ident output are inhibited by allowing a current of 0.75mA (Typ.) or more to flow through pin 11.</p> <p>Color difference output signals are cut off when the pin 21 flow-in current is 0.75mA (Typ.).</p> <p>Set the high level of forced (manual) mode within a range of <math>6 \pm 0.5V</math>.</p>	

PIN No.	PIN NAME	FUNCTION	INTERFACE CIRCUIT
12	Delayed Chroma Signal Input	1H delayed chroma signal input for PAL/SECAM. The signal phase shift between pin 14 and pin 12 should be less than 5°. The signal loss of the 1H delay line should be 16dB.	
13	Bias	An external capacitor for a bias circuit is connected.	
14	Delay Line Driver Output	The PAL/SECAM chroma signal output for a 1H delay line. Connect a load Resistor of 2kΩ to GND.	
15	Tint Control (NTSC Mode)	A phase of burst signal is controlled by this terminal in the NTSC mode. On 312/313H TELETEXT application, the applied voltage of pin 15 sets less than DC 2.0V, and then the synchronization system is locked at 312/313H TELETEXT signal. For receiving normal TV or VCR signal, the applied voltage sets more than DC 2.0V. For PAL and SECAM, the pin 15 should be AC grounded.	
16	ACC Filter	An external capacitor for ACC filter is connected.	

PIN No.	PIN NAME	FUNCTION	INTERFACE CIRCUIT
17	Bypass Filter	An external bypass capacitor for a bias circuit is connected.	
18	SECAM Signal Input	SECAM chroma signal is led to this terminal through a Bell filter circuit. Terminal DC voltage is changed by the 50/60 identification logic output. 7.50V for 60Hz 4.45V for 50Hz This identification output is useful for changing a vertical size and shifting a horizontal position on the screen.	
19	GND	GND of the chroma stage.	
20	PAL/NTSC Chroma Signal Input	PAL/NTSC chroma signal is led to this terminal through Band pass filter circuit. The SECAM identification mode is determined by this terminal DC voltage. Open : Line Ident. 15kΩ to GND : Line + Frame Ident.	
22 23 27	Ident Filter	An external capacitor for Ident filter is connected. Pin 22 : PAL Ident Filter Pin 23 : SECAM Ident Filter Pin 27 : NTSC Ident Filter	



PIN No.	PIN NAME	FUNCTION	INTERFACE CIRCUIT
24	SECAM Ident Discriminator	<p>A 4.328MHz tuned tank circuit for SECAM Identification is connected.</p> <p>Adjust tank coil so that the recovered DC voltage at pin 23 is maximum value for 4.328MHz.</p>	
25	APC Filter	<p>APC filter time constant is connected.</p> <p>When the killer operates, automatic searching circuits operate to widen the pull in range of the APC circuit. The external time constant also determines the searching speed.</p>	
26 28	X'tal In	<p>Pin 26 : 3.58MHz X'tal IN 3.58MHz X'tal is connected between the pin 26 and pin 30.</p> <p>Pin 28 : 4.43MHz X'tal IN 4.43MHz X'tal is connected between the pin 28 and pin 30.</p> <p>No adjustment is required.</p>	
29	Vertical Output	<p>Output terminal of vertical driver.</p>	

PIN No.	PIN NAME	FUNCTION	INTERFACE CIRCUIT
30	X'tal Drive	X'tal is connected between the pin 26, 28 and pin 30.	
31	Ramp Generator	A vertical saw tooth wave generator circuit is composed by a ramp capacitor, a zener diode which determines a saw tooth starting voltage, and a discharge resistor.	
32	Vertical NFB	AC and DC Negative Feed Back terminal. The wave form of pin 32 is equivalent to that of pin 31 according to internal operational Amplifier.	
33	Sync. Sep. Input	<p>Input terminal of emitter-time constant type sync. separator.</p> <p>Sync. Sep. level is ;</p> $V_{th} \approx \frac{(6 + V_i) R_1 T_r}{R_1 T_r + R_2 T_s}$	
34	Gate Pulse Filter	An external filter for a gate pulse is connected.	

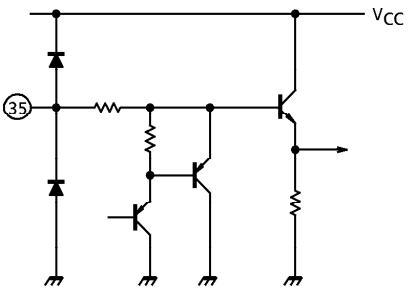
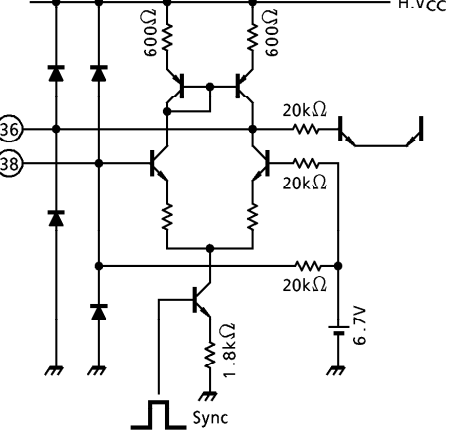
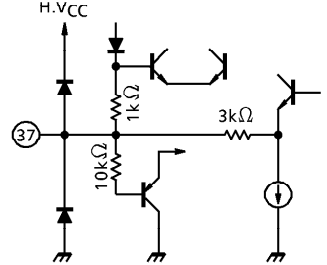
PIN No.	PIN NAME	FUNCTION	INTERFACE CIRCUIT
35	Flyback Pulse Input/Sync. Pulse Output	<p>Flyback Pulse is used as a Horizontal Blanking of color differential signal output (pin 2, 64), color primary signal output (pin 41, 42, 43) and 1H delay line output (pin 14), and also used as a masking pulse for a gate pulse generator, PAL matrix switching, and a SECAM permutator switching. This terminal is also the output of sync. signal. During Sync. period, the terminal voltage of pin 35 turns to high.</p>	
36	AFC Filter	<p>An external capacitor and resistor for AFC filter are connected.</p>	
38	Integrated Flyback Pulse Input	<p>A saw tooth type horizontal AFC circuit is composed. Pin 38 is an input terminal of integrated flyback pulse (saw-tooth). Pin 36 is an AFC filter terminal for <math>32f_H</math> VCO. Time constants for integration of flyback pulse should be switched so that a screen position is equivalent for 15.734kHz and 15.625kHz of horizontal frequency.</p>	
37	$32f_H$ VCO	<p>Adjustment free <math>32f_H</math> Voltage Controlled Oscillator. A ceramic resonator is connected. A wide Pull-in range covers both 15.625kHz and 15.734kHz of horizontal frequency.</p>	

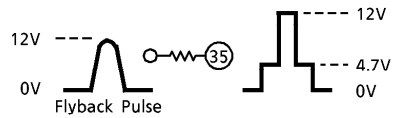

PIN No.	PIN NAME	FUNCTION	INTERFACE CIRCUIT
39	Horizontal Driver Output	An emitter follower output of horizontal pre-driver. An external load resistor is required.	
40	H.VCC	Supply terminal for a horizontal deflection circuit. Recommended supply voltage is 9.0V. A Bypass capacitance is connected to the pin 50.	
41 42 43	Color Primary Signal Output	Pin 41 : R out Pin 42 : G out Pin 43 : B out	
44 45 46	Clamp Capacitor	Clamp Capacitor for DC restoration is connected. Pin 44 R Pin 45 G Pin 46 B	
47 49 51	External RGB Signal Inputs	An input decoupling capacitor is used as a clamp capacitor. Input signal level is 0.7V <sub>p-p</sub> . Pin 47 R input Pin 49 G input Pin 51 B input	

PIN No.	PIN NAME	FUNCTION	INTERFACE CIRCUIT										
48	Brightness Control	Pedestal level of RGB output signals increases when the terminal voltage increases.											
50	GND	GND for Video circuit and Deflection circuit.											
52	X-ray	The input terminal of the X-ray protector. Pin 39 Hor. drive terminal turns to low when the input voltage of this terminal exceeds the specified threshold voltage. (1.3V typ.)											
53	TV/EXT Switching Signal Input	Fast Blanking pulse is acceptable. The threshold level is shown below. <table border="1" data-bbox="641 1123 852 1312" style="margin-left: auto; margin-right: auto;"> <thead> <tr> <th colspan="2" style="text-align: center;">V<sub>53</sub> [V]</th> </tr> </thead> <tbody> <tr> <td style="text-align: center;">6</td> <td style="text-align: center;">RGB BLK Inhibit</td> </tr> <tr> <td style="text-align: center;">4</td> <td style="text-align: center;">TV BLK Enable</td> </tr> <tr> <td style="text-align: center;">0.7</td> <td style="text-align: center;">RGB BLK Enable</td> </tr> <tr> <td style="text-align: center;">0</td> <td style="text-align: center;">TV BLK Inhibit</td> </tr> </tbody> </table>	V <sub>53</sub> [V]		6	RGB BLK Inhibit	4	TV BLK Enable	0.7	RGB BLK Enable	0	TV BLK Inhibit	
V <sub>53</sub> [V]													
6	RGB BLK Inhibit												
4	TV BLK Enable												
0.7	RGB BLK Enable												
0	TV BLK Inhibit												

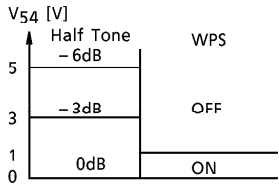
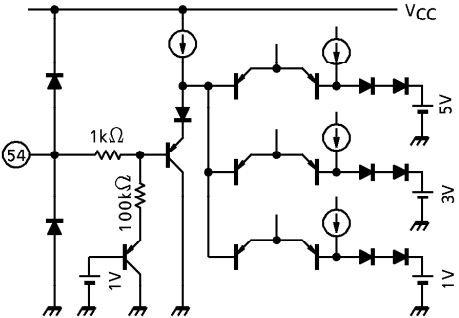
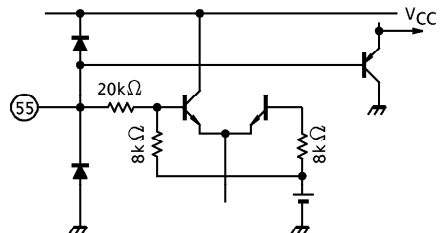
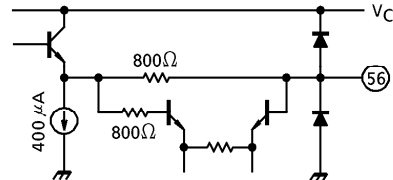
PIN No.	PIN NAME	FUNCTION	INTERFACE CIRCUIT
54	Half Tone / Full Tone Switching Signal Input	<p>When a half tone circuit is active, the TV video signal amplitude becomes smaller than nominal level.                      WPS (white peak suppress) Switch                      This terminal also switches the white peak suppress circuits.                      When this circuit is active, in case the RGB output voltage becomes higher than 7.5V, the contrast control terminal voltage is lowered by internal open collector circuit.                      Time constant is determined by external capacitance and variable resistor value at pin 59.</p> 	
55	Picture Sharpness Control / Mute Switch	<p>When pin 55 voltage becomes lower than 0.7V, Mute function operates. The brightness control circuit becomes the same condition that 3V is applied at pin 48, TV / EXT switch turns to TV mode, and the video signal and the color differential signal are cut.</p>	
56	Second Order Differential Video Signal Input	<p>Second order differential video signal component is applied to this terminal.</p>	

PIN No.	PIN NAME	FUNCTION	INTERFACE CIRCUIT
57	Clamp	A terminal for a pedestal clamp capacitor.	
58	Video Input	A video signal of sync. negative going should be applied.	
59	TV Contrast Control With Uni-color Control Text Contrast Control	Video gain and color gain are controlled simultaneously. The typical gain control range is -20dB. Contrast control terminal for external RGB signal. The typical gain control range is -12dB.	
60 62	Color Differential Signal Input	The decoupling capacitor is used as a clamp capacitor. Pin 60 : R-Y input Pin 62 : B-Y input	
61	VCC	VCC for Video and Vertical Deflection stage. (12V) Bypass Capacitor is connected to pin 50.	
63	VCC	VCC for RGB output stage. (12V) Bypass Capacitor is connected to pin 50.	—

**LOGIC TABLE AT AUTOMATIC MODE**

IDENT			X'tal MODE	SW1	SW2	SW3	MODE SELECT
PAL	SECAM	NTSC		PIN 10	PIN 11	PIN 21	
PIN 22	PIN 23	PIN 27					
H	L	H	4.43	H	H	M	PAL
L	H	L	4.43	H	M	M	SECAM
L	L	H	4.43	L	H	M	4.43 NTSC
L	L	H	3.58	L	L	M	3.58 NTSC
L	L	L	4.43 / 3.58	L	M / L	L	B / W
Output DC level H→VCC L = 6V			—	Output DC level H = 6.0V (1 / 2V <sub>CC</sub> ) M = 2.0V (1 / 6V <sub>CC</sub> ) L = 0V (Connect to GND through 30kΩ)			—

**INPUT VOLTAGE AT FORCED (MANUAL) MODE**

MODE	SW1	SW2	SW3
	PIN 10	PIN 11	PIN 21
PAL	H	H	H
SECAM	H	(M)	H
4.43 NTSC	(L)	H	H
3.58 NTSC	(L)	(L)	H

H : 6V ± 0.5V

L : 0V

(L), (M) levels are generated internally.



FLOW CHART OF SYSTEM IDENTIFICATION

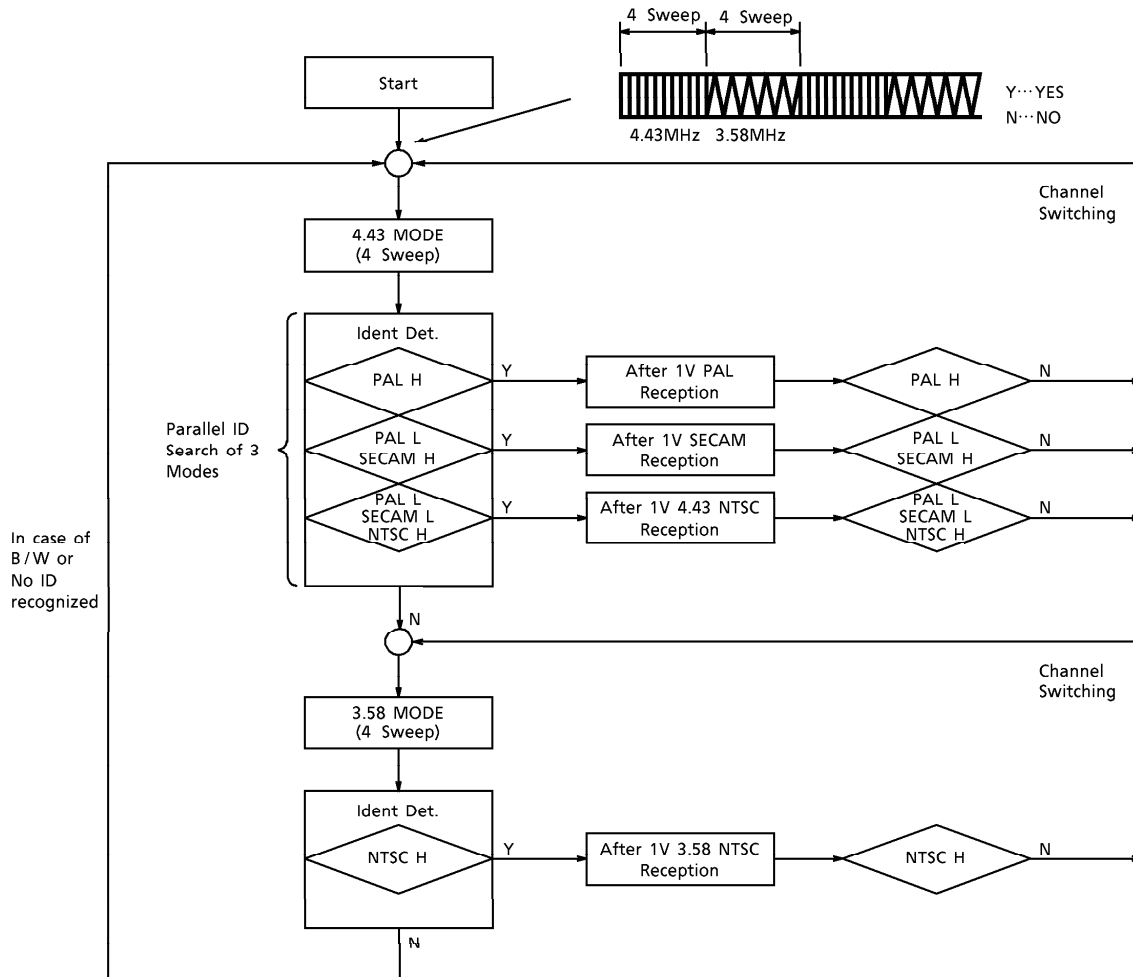

**MAXIMUM RATINGS** (Ta = 25°C)

CHARACTERISTIC	SYMBOL	RATING	UNIT
Supply Voltage	V <sub>CC</sub>	15.0	V
Input Terminal Voltage	V <sub>IN</sub>	GND - 0.3V ~ V <sub>CC</sub> + 0.3V	V
Input Signal Level	e <sub>IN</sub>	5.0	V <sub>p-p</sub>
Power Dissipation	P <sub>D</sub> (Note)	2660	mW
Operating Temperature	T <sub>opr</sub>	-20 ~ 65	°C
Storage Temperature	T <sub>stg</sub>	-55 ~ 150	°C

(Note) When using the device at above Ta = 25°C, decrease the power dissipation by 21.2mW for each increase of 1°C.

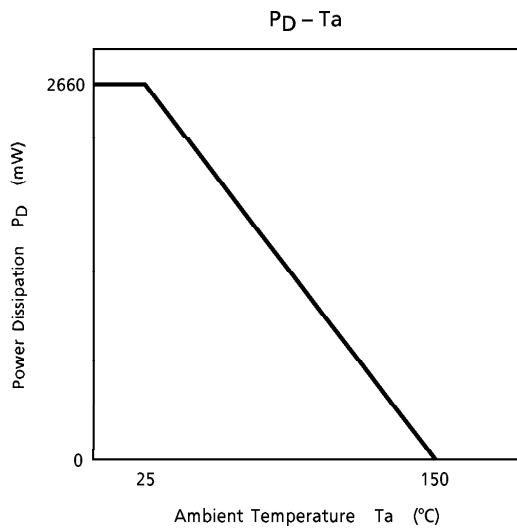

**RECOMMENDED SUPPLY VOLTAGE**

PIN NO.	PIN NAME	MIN.	TYP.	MAX.	UNIT
6, 61, 63	V <sub>CC</sub> (12V)	10.8	12.0	13.2	V
40	H. V <sub>CC</sub> (9V)	8.1	9.0	9.9	

(Note) Same supply voltage should be applied to pin 6, 61 and 63.

**ELECTRICAL CHARACTERISTIC**

**DC CHARACTERISTICS**

Terminal voltage characteristics (Unless otherwise specified,  $V_{CC} = 12V$ ,  $H.V_{CC} = 9V$ ,  $T_a = 25^{\circ}C$ )

PIN No.	PIN NAME	SYMBOL	MIN.	TYP.	MAX.	UNIT	NOTE	
1	SECAM B-Y De-Emphasis	$V_1$	8.3	8.65	9.0	V	—	
2	R-Y Output	$V_2$	7.4	7.95	8.4			
3	SECAM R-Y De-Emphasis	$V_3$	8.3	8.65	9.0			
4	SECAM B-Y Det	$V_4$	6.0	6.5	7.0			5.5V in SECAM MODE
5		$V_5$	6.0	6.5	7.0			
6	$V_{CC}$	$V_6$	—	$V_{CC}$	—			—
7	Color Control	$V_7$	—	—	—			—
8	SECAM R-Y Det	$V_8$	6.0	6.5	7.0			5.5V in SECAM MODE
9		$V_9$	6.0	6.5	7.0			
10	SW1	$V_{10}$	5.4	6.0	6.6			PAL, SECAM MODE
11	SW2	$V_{11}$	5.4	6.0	6.6			PAL, 4.43NTSC MODE
12	Delay Line Input	$V_{12}$	4.8	5.2	5.6			—
13	Bias	$V_{13}$	4.8	5.2	5.6			—
14	Delay Line Drive	$V_{14}$	9.5	10.05	10.6			NTSC, B/W MODE 7.6V at P/S MODE
15	Tint Control	$V_{15}$	5.5	5.9	6.3			—
16	ACC Filter	$V_{16}$	—	11.3	—			B/W MODE, 10.7V at P/N MODE (100mV <sub>p-p</sub> Burst)
17	DC Feed Back	$V_{17}$	3.2	3.55	3.9			—
18	SECAM Input	$V_{18}$	4.1	4.45	4.8			50Hz MODE, 7.5V at 60Hz MODE
19	GND	$V_{19}$	—	GND	—			—
20	PAL/NTSC Input	$V_{20}$	5.5	5.85	6.2			HID MODE, 4.8V at VID (15k $\Omega$ GND)
21	SW3	$V_{21}$	1.6	2.0	2.8			PAL, SECAM, NTSC MODE
22	PAL Ident	$V_{22}$	4.1	4.35	4.8			—
23	SECAM Ident	$V_{23}$	4.1	4.35	4.8			
24	SECAM Reference	$V_{24}$	5.4	5.8	6.2			
25	APC Filter	$V_{25}$	—	4.8	—			—
26	3.58X'tal	$V_{26}$	2.8	3.15	3.5			
27	NTSC Ident	$V_{27}$	4.1	4.45	4.8			
28	4.43X'tal	$V_{28}$	2.8	3.15	3.5			
29	Vertical Drive	$V_{29}$	—	—	—			
30	VCO	$V_{30}$	7.0	8.0	9.0			
31	Vertical Ramp	$V_{31}$	—	—	—			
32	Vertical NFB Input	$V_{32}$	—	—	—			
33	Sync. Separation Input	$V_{33}$	5.4	6.0	6.6			
34	Gate Pulse Filter	$V_{34}$	—	—	—			

PIN No.	PIN NAME	SYMBOL	MIN.	TYP.	MAX.	UNIT	NOTE
35	H.BLK Input	V <sub>35</sub>	4.2	4.6	5.0	V	—
36	AFC Filter	V <sub>36</sub>	7.0	7.5	8.0		
37	VCO	V <sub>37</sub>	5.4	6.1	6.8		
38	H.AFC Pulse Input	V <sub>38</sub>	6.3	6.7	7.1		
39	Horizontal Output	V <sub>39</sub>	—	—	—		
40	H.V <sub>CC</sub>	V <sub>40</sub>	—	H.V <sub>CC</sub>	—		
41	R Output	V <sub>41</sub>	0.7	1.25	1.8		
42	G Output	V <sub>42</sub>	0.7	1.25	1.8		
43	B Output	V <sub>43</sub>	0.7	1.25	1.8		
44	R Clamp	V <sub>44</sub>	—	3.2	—		
45	G Clamp	V <sub>45</sub>	—	3.2	—		
46	B Clamp	V <sub>46</sub>	—	3.2	—		
47	Ext. R Input	V <sub>47</sub>	—	6.0	—		
48	Brightness Control	V <sub>48</sub>	—	—	—		
49	Ext. G Input	V <sub>49</sub>	—	6.0	—		
50	GND	V <sub>50</sub>	—	GND	—		
51	Ext. B Input	V <sub>51</sub>	—	6.0	—		
52	X-ray	V <sub>52</sub>	—	—	—		
53	TV / EXT. SW	V <sub>53</sub>	—	—	—		
54	Half Tone	V <sub>54</sub>	—	—	—		
55	Picture Sharpness	V <sub>55</sub>	5.0	5.4	5.8		
56	Diff. Input	V <sub>56</sub>	2.9	3.25	3.6		
57	Clamp	V <sub>57</sub>	—	5.9	—		
58	Video Input	V <sub>58</sub>	4.4	4.8	5.2		
59	Contrast Control	V <sub>59</sub>	—	—	—		
60	R-Y Input	V <sub>60</sub>	5.8	6.2	6.6		
61	V <sub>CC</sub>	V <sub>61</sub>	—	V <sub>CC</sub>	—		
62	B-Y Input	V <sub>62</sub>	5.8	6.2	6.6		
63	V <sub>CC</sub>	V <sub>63</sub>	—	V <sub>CC</sub>	—		
64	B-Y Output	V <sub>64</sub>	7.4	7.95	8.4		

Current characteristics (Unless otherwise specified, V<sub>CC</sub> = 12V, H.V<sub>CC</sub> = 9V, Ta = 25°C)

PIN No.	PIN NAME	SYMBOL	MIN.	TYP.	MAX.	UNIT	NOTE
6	V <sub>CC</sub> (CHROMA)	I <sub>1</sub>	30	42	65	mA	—
61	V <sub>CC</sub> (VIDEO, DEF.)	I <sub>2</sub>	25	38	55		
63	V <sub>CC</sub> (VIDEO)	I <sub>3</sub>	8	10	15		
40	H.V <sub>CC</sub> (H.DEF.)	I <sub>4</sub>	4	8	13		
V <sub>CC</sub> Total Current		I <sub>CC1</sub>	63	90	135		I <sub>CC1</sub> = I <sub>1</sub> + I <sub>2</sub> + I <sub>3</sub>
H.V <sub>CC</sub> Total Current		I <sub>CC2</sub>	4	8	13		I <sub>CC2</sub> = I <sub>4</sub>

AC CHARACTERISTICS (Unless otherwise specified,  $V_{CC} = 12V$ ,  $H.V_{CC} = 9V$ ,  $T_a = 25^\circ C$ )  
Video stage

CHARACTERISTIC	SYMBOL	TEST CIRCUIT	TEST CONDITION	MIN.	TYP.	MAX.	UNIT
Diff. Input (Pin 56) Input Impedance	$Z_{in56}$	2	(Note 1)	700	910	1150	$\Omega$
Video Input (Pin 58) Input Impedance	$Z_{in58}$	2	(Note 2)	14	20	24	$k\Omega$
Dynamic Range Of Video Input	$V_{ri}$	2	(Note 3)	2.9	3.4	—	V
Min. Output	$V_{do1}$	2	(Note 4)	0.1	0.3	0.6	V
Max. Output	$V_{do2}$	2	(Note 5)	7.7	8.1	8.5	V
	$V_{do3}$			7.1	7.5	7.9	
White Peak Limit Level	$V_{PL}$	2	(Note 6)	7.1	7.5	7.9	V
White Peak Slice Level	$V_{PS}$	2	(Note 7)	7.7	8.1	8.5	V
Dynamic Range Of 2'nd Order Differential Video Input	$V_{dYP}$	2	(Note 8)	0.3	0.4	0.6	V
AC Gain (Y)	$G_Y$	2	(Note 9)	5.9	7.7	8.9	
Frequency Characteristic (Y)	$F_Y$	2	(Note 10)	8	10	—	MHz
Uni-color Control Adjust Voltage Range (Y)	$\Delta V_{UY}$	2	(Note 11)	1.0	1.5	2.0	V
Gain Variation Range By Uni-color Adjustment (Y)	$\Delta G_{UY}$	2	(Note 12)	20	21	22	dB
Uni-color Adjustment Control Range (Y)	$V_{UY}^C$	2	(Note 13)	3.0	3.3	3.6	V
Uni-color Adjustment Control Range (U, V)	$V_{UC}^C$	2	(Note 14)	3.0	3.3	3.6	V
Gain Variation Range By Uni-color Adjustment (U, V)	$\Delta G_{UC}$	2	(Note 15)	20	21	22	dB
Uni-color Control Adjust Voltage Range (U, V)	$\Delta V_{UC}$	2	(Note 16)	1.0	1.4	1.8	V
Gain Of Picture Sharpness Control	$G_{PS}$	2	(Note 17)	17.0	18.5	20.0	dB
Picture Sharpness Control Range	$\Delta V_{\#55}$	2	(Note 18)	1.8	2.4	3.0	V
Half Tone (Y)	$\Delta V_{3T1}$	2	(Note 19)	-3.5	-3.0	-2.5	dB
	$\Delta V_{3T2}$			-6.5	-6.0	-5.5	
Half Tone Switching Level (Y)	$S_W^{-3dB}$	2	(Note 20)	2.7	3.0	3.3	V
	$S_W^{-6dB}$			4.8	5.1	5.4	
	$S_W^{ACL}$		(Note 21)	0.7	1.0	1.2	
Half Tone (U, V)	$\Delta V_{R-Y1}$	2	(Note 22)	-3.5	-3.0	-2.5	dB
	$\Delta V_{B-Y1}$						
	$\Delta V_{R-Y2}$			-6.5	-6.0	-5.5	
	$\Delta V_{B-Y2}$						

CHARACTERISTIC	SYMBOL	TEST CIR-CUIT	TEST CONDITION	MIN.	TYP.	MAX.	UNIT
Color Control Variable Range	$\Delta V\#7$	2	(Note 23)	1.0	1.4	1.8	V
Color Control Center Voltage	$V\#7C$			3.0	3.3	3.6	
AC Gain (R-Y)	$G_{R-Y}$	2	(Note 24)	7.2	10.4	14.8	
AC Gain (B-Y)	$G_{B-Y}$	2	(Note 25)	13.0	18.5	26.2	
Relative Amplitude 1 (PAL/SECAM)	$\frac{G-Y}{R-Y}$	2	(Note 26)	-0.56	-0.51	-0.46	—
	$\frac{G-Y}{B-Y}$		(Note 27)	-0.21	-0.19	-0.17	
Relative Amplitude 2 (NTSC)	$\frac{G-Y}{R-Y}$	2	(Note 28)	-0.35	-0.32	-0.29	—
	$\frac{G-Y}{B-Y}$		(Note 29)	-0.24	-0.22	-0.20	
Dynamic Range Of R-Y Input	$\Delta V_{R-Y}$	2	(Note 30)	2.6	3.2	4.2	V
Dynamic Range Of B-Y Input	$\Delta V_{B-Y}$	2	(Note 31)	1.5	1.8	2.4	V
Frequency Response Of Color Differential Signal	$F_D$	2	(Note 32)	3	5	—	MHz
Brightness Control Gain	$G_{BR}$	2	(Note 33)	0.9	1.0	1.1	
Brightness Control Adjust Voltage	$V\#48$	2	(Note 34)	2.9	3.2	3.5	V
V.BLK Pulse Output Level	$V_{VR}, V_{VG}, V_{VB}$	2	(Note 35)	1.0	1.5	2.0	V
H.BLK Pulse Output Level	$V_{HR}, V_{HG}, V_{HB}$	2	(Note 36)	1.0	1.5	2.0	V
DC Restoration Ratio	$T_{DC}$	2	(Note 37)	95	98	100	%
Mute SW ON Level	$V\#56S$	2	(Note 38)	0.5	0.7	1.0	V

Data stage

CHARACTERISTIC	SYMBOL	TEST CIR-CUIT	TEST CONDITION	MIN.	TYP.	MAX.	UNIT
Data Contrast Gain Variation Range	$\Delta G_{TC}$	2	Note 40	13.5	15	16.5	dB
Data Contrast Control Voltage Range	$\Delta V_{TC}$			1.1	1.6	2.2	V
Data Contrast Control Center Voltage	$V_{TC}^C$			3.0	3.3	3.6	V
Input Dynamic Range	$V_{DI}$	2	Note 41	2.0	—	—	$V_{p-p}$
Input Clamp Level	$V_{TIN}^{MIN}$	2	Note 42	4.0	6.0	8.0	V
	$V_{TIN}^{MAX}$		Note 43	6.7	7.4	8.1	
Gain	$G_T$	2	Note 44	16	17	18	dB
Rise Time	$\tau_R$	2	Note 45	—	25	—	ns
Propagation Time (Rising Edge)	$t_{pR}$			—	25	—	
Fall Time	$\tau_F$			—	25	—	
Propagation Time (Falling Edge)	$t_{pF}$			—	25	—	
Data Input ON Level	$V_{TSW}^{ON}$	2	Note 46	1.0	—	—	V
Data Input OFF Level	$V_{TSW}^{OFF}$			—	—	0.5	
Video→Data Switching Time	$t_{SVD}$	2	Note 47	—	40	—	ns
Data→Video Switching Time	$t_{SDV}$			—	40	—	
Cross Talk Data→Video	$CT_T$	2	Note 48	-43	-50	—	dB
Cross Talk Video→Data	$CT_Y$	2	Note 49	-43	-50	—	dB
Band Width Of Data	$F_T$	2	Note 50	14	19	—	MHz
Clamp Voltage	$V_{44}, V_{45}, V_{46}$	2	Note 51	2.3	3.3	4.3	V
Blanking Input Threshold Voltage	$V_{BLK}^{ON}$	2	Note 52	1.5	2.0	2.5	V
Blanking Pulse Delay Time	$t_{dBP}^{ON}$	2	Note 53	—	0.35	0.5	$\mu s$
	$t_{dBP}^{OFF}$			0.76	0.86	0.96	

Chroma stage

CHARACTERISTIC	SYMBOL	TEST CIR-CUIT	TEST CONDITION	MIN.	TYP.	MAX.	UNIT
Chroma Amplitude	V <sub>13PC</sub>	2	Note 54	0.10	0.15	0.22	V <sub>p-p</sub>
	V <sub>13nc 3.58</sub>			0.11	0.17	0.25	
ACC Characteristic	e <sub>apc</sub>	2	Note 55	0.03	0.06	—	V <sub>p-p</sub>
	A			0.90	1.00	1.30	—
Delay Line Amp. Gain	V <sub>14PC</sub>	2	Note 56	0.96	1.20	1.92	V <sub>p-p</sub>
	GDL			15.0	18.0	21.0	dB
Tint Control Voltage	V <sub>15 3.58n</sub>	2	Note 57	5.50	6.00	6.50	V
Tint Control Voltage Range	ΔV <sub>15 3.58n</sub>	2	Note 58	1.50	2.20	2.90	V
Tint Control Range	Δθ <sub>15 3.58n</sub>	2	Note 59	77	101	131	°
	Δθ <sub>15 4.43n</sub>			65	90	121	
Tint Control Symmetricity	Δθ <sub>1 3.58n</sub>	2	Note 60	35	51.8	—	°
	Δθ <sub>1 4.43N</sub>			30	41.9	—	
	Δθ <sub>2 3.58n</sub>			35	49.4	—	
	Δθ <sub>2 4.43N</sub>			30	47.3	—	
4.43 APC Pull In And Hold Range	f <sub>4PH</sub>	2	Note 61	0.3	0.6	1.0	kHz
	f <sub>4PL</sub>			0.3	0.6	1.0	
	f <sub>4HH</sub>			0.3	0.6	1.0	
	f <sub>4HL</sub>			0.3	0.6	1.0	
3.58 APC Pull In And Hold Range	f <sub>3PH</sub>	2	Note 62	0.3	0.6	1.0	kHz
	f <sub>3PL</sub>			0.3	0.6	1.0	
	f <sub>3HH</sub>			0.3	0.6	1.0	
	f <sub>3HL</sub>			0.3	0.6	1.0	
Frequency Control Sensitivity	β <sub>4.4</sub>	2	Note 63	1.4	2.4	3.4	Hz / mV
	β <sub>3.5</sub>		Note 64	0.9	1.5	2.1	
APC Pull In Voltage	ΔV <sub>25-4</sub>	2	Note 65	4.6	4.8	5.0	V
	ΔV <sub>25-3</sub>			4.6	4.8	5.0	
APC Pull In Sweep Amplitude	SV1	2	Note 66	5.1	5.3	5.5	V
	SV2			4.1	4.3	4.5	
	SV3			0.7	1.0	1.3	
APC Pull In Sweep Period	t <sub>1</sub>	2	Note 66	7	16	25	ms
	t <sub>2</sub>			60	80	100	
	t <sub>3</sub>			67	96	125	
Color Difference Output	V <sub>2PR</sub>	2	Note 67	0.40	0.65	0.90	V <sub>p-p</sub>
	V <sub>64PB</sub>			0.40	0.65	0.90	
	V <sub>2nR</sub>			0.50	0.75	1.00	—
	V <sub>2NR</sub>			0.45	0.68	0.90	
	V <sub>64nB</sub>			0.30	0.50	0.70	
	V <sub>64NB</sub>			0.40	0.61	0.82	



CHARACTERISTIC		SYMBOL	TEST CIRCUIT	TEST CONDITION	MIN.	TYP.	MAX.	UNIT
Relative Amplitude	$\frac{V_{2PR}}{V_{64PB}}$		2	Note 68	0.85	1.00	1.15	—
	$\frac{V_{2nR}}{V_{64nB}} \left( \frac{V_{2NR}}{V_{64NB}} \right)$				1.32	1.53	1.77	
Relative Phase	$\theta_{2PR}$		2	Note 69	85	90	95	°
	$\theta_{2nR}, \theta_{2NR}$				102	109	116	
Characteristics Of SECAM Limiter	$e_{18}$		2	Note 70	20	30	44	mV <sub>p-p</sub>
	$e_{13}$				310	460	670	
	$\Delta e_{13}$				-50	0	50	
SECAM Color Difference Output	$V_{2SR}$		2	Note 71	0.75	1.25	1.75	V <sub>p-p</sub>
	$V_{64SB}$				0.60	1.00	1.40	
SECAM Relative Amplitude	$\frac{V_{2S}}{V_{64S}}$		2	Note 72	1.00	1.15	1.33	—
Band Width Of SECAM Demodulated Signal	2B		2	Note 73	0.80	1.15	—	MHz
	64B				0.80	1.15	—	
SECAM Cross Talk	RC		2	Note 74	30	—	—	dB
	BC				30	—	—	
50 / 60 Detection	$V_{18-50}$		2	Note 75	4.2	4.5	4.8	V
	$V_{18-60}$				7.0	7.3	7.6	
Output Voltage Of SW1 (Pin 10)	PAL, SECAM		2	—	5.4	6.0	6.6	V
	NTSC, B/W				0	0	0.4	
Output Voltage Of SW2 (Pin 11)	PAL, 4.43NTSC		2	—	5.4	6.0	6.6	V
	SECAM, B/W I				1.6	2.0	2.8	
	3.58NTSC, B/W II				0	0	0.4	
Output Voltage Of SW3 (Pin 21)	PAL, SECAM, NTSC		2	—	1.6	2.0	2.8	V
	B/W				0	0	0.4	
Ident Input Level	P <sub>IN</sub> B/W		2	Note 76	0.6	1.0	1.7	mV <sub>p-p</sub>
	N <sub>IN</sub> B/W				0.4	0.7	1.3	
	S <sub>IN</sub> B/W			Note 77	0.6	1.0	1.7	
	P <sub>IN</sub> COLOR				Note 78	0.6	2.5	
	N <sub>IN</sub> COLOR			Note 79		0.4	1.8	
	S <sub>IN</sub> COLOR				0.6	1.0	1.7	
Ident Voltage	PC		2	Note 80	—	6.4	—	V
	PS				—	6.4	—	
	NC			Note 81	—	6.4	—	
	NS				—	6.4	—	
	SC			Note 82	—	6.4	—	

## Deflection stage

CHARACTERISTIC	SYMBOL	TEST CIR-CUIT	TEST CONDITION	MIN.	TYP.	MAX.	UNIT
Sync. Separation Input Current Sensitivity	$I_{IN33}$	2	Note 83	35	50	65	$\mu A$
H. AFC Phase Detection Current	$I_{DET}$	2	Note 84	0.45	0.55	0.7	mA
Phase Detection Masked Period	$T_{CO60}$	2	Note 85	—	258.25 ~5.75	—	H
	$T_{CO50}$			—	308.25 ~5.75	—	
32f <sub>H</sub> VCO Oscillation Stage Voltage	$V_{ON37}$	2	Note 86	4.5	5.0	5.3	V
Horizontal Output Start Voltage	$V_{ON39}$	2	Note 87	5.4	5.8	6.3	
Horizontal Free Running Frequency	$f_o$	2	Note 88	15.57	15.72	15.87	kHz
Horizontal Frequency Oscillation Range	$f_{MAX}$	2	Note 89	16.65	16.80	16.95	
	$f_{MIN}$			14.70	15.00	15.25	
Horizontal Frequency Control Sensitivity	$\beta_H$	2	Note 90	1.8	2.1	2.4	kHz / V
Horizontal Output Duty Ratio	$T_{O39}$	2	Note 91	40	42	44	%
X-ray Protection Threshold Voltage	$V_{I52}$	2	Note 92	1.1	1.3	1.5	V
X-ray Protection Hold Voltage	$V_{H52}$	2	Note 93	—	—	2.5	
X-ray Protector Current Sensitivity	$I_{I52}$	2	Note 94	—	—	2.5	$\mu A$
Horizontal Output Voltage	$V_{H39}$	2	Note 95	4.8	5.1	5.4	V
	$V_{L39}$			—	0	0.1	
Vertical Output Pulse Width	$T_{O31}$	2	Note 96	—	10	—	H
Vertical Amplifier Gain	$G_V$	2	Note 97	17	20	23	dB
Vertical Output Dynamic Range	$V_{H29}$	2	Note 98	3.0	3.5	4.0	V
	$V_{L29}$			—	0	0.1	
Max. Output Current Of Vertical Ramp Generator	$I_{MAX31}$	2	Note 99	12	15	—	mA
Pull In Range Of Vertical Oscillator	$V_{pull}$	2	Note 100	—	248.5 ~353	—	H
60Hz Detector Ident Range	$V_{pull60}$	2	Note 101	—	248.5 ~288	—	H
Vertical Blanking Pulse Width	$T_{B60}$	2	Note 102	—	16	—	H
	$T_{B50}$			—	23	—	
Phase Of Gate Pulse NTSC / PAL	$T_{PN I}$	2	Note 103	—	0.6	—	$\mu s$
	$T_{PN II}$			—	3.1	—	
Phase Of Gate Pulse SECAM	$T_{S I}$	2	Note 104	—	3.1	—	$\mu s$
	$T_{S II}$			—	4.8	—	

TEST CONDITION  
Video stage

NOTE No.	ITEM	SYMBOL	SW & VR MODE					TEST METHOD	
			UNI-COLOR	SHARP-NESS	COLOR	BRIGHT-NESS	PIN 56		PIN 58
1	Diff. Input (Pin 56) Input Impedance	Z <sub>in56</sub>	Min.	Open	Min.	Center	Input	AC GND	(1) Measure DC Voltage of pin 56. V <sub>#56A</sub> (2) Measure DC Voltage of pin 56 connecting 10kΩ to GND. V <sub>#56B</sub> (3) Z <sub>in#56</sub> = $1 \times 10^4 \times \left( \frac{V_{\#56A}}{V_{\#56B}} - 1 \right)$
2	Video Input (Pin 58) input Impedance	Z <sub>in58</sub>					AC GND	Input	(1) Measure DC Voltage of pin 58. V <sub>#58A</sub> (2) Measure DC Voltage of pin 58 connecting 20kΩ to GND. V <sub>#58B</sub> (3) Z <sub>in#58</sub> = $2 \times 10^4 \times \left( \frac{V_{\#58A}}{V_{\#58B}} - 1 \right)$
3	Dynamic Range Of Video Input	V <sub>ri</sub>				Adj.		AC GND	(1) Adjust Brightness Control VR to get 3.0V at pin43 during trace period. (2) Measure the Voltage of pin 46, and apply the voltage to pin 46. (3) Measure the Voltage of pin 57, and apply the voltage to pin 57. (4) Vary the DC Voltage of pin 58 and measure the changes at pin 43. (5) Measure input voltage at pin 58, which give 10% (V <sub>ri1</sub> ) and 90% (V <sub>ri2</sub> ) of pin 43.

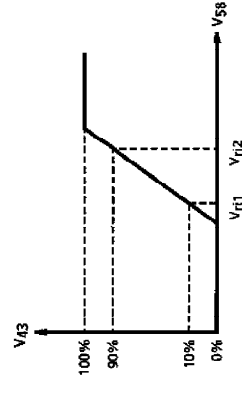

NOTE No.	ITEM	SYMBOL	SW & VR MODE						TEST METHOD		
			UNI-COLOR	SHARP-NESS	COLOR	BRIGHT-NESS	PIN56	PIN58		PIN54	
4	Min. Output	$V_{do1}$	Max.	Open	—	Min.	Adj.	AC GND	AC GND	—	<p>(1) Adjust Brightness Control VR to get 3.0V at pin43 during trace period.</p> <p>(2) Measure the Voltage of pin46, and apply the voltage to pin 46.</p> <p>(3) Measure the Voltage of pin57, and apply the voltage to pin 57.</p> <p>(4) Vary the DC voltage of pin58 to change output at pin43.</p> <p>(5) Measure the Min. Voltage (<math>V_{do1}</math>) and Max. Voltage (<math>V_{do2}</math>) at pin 43.</p> <p>(6) Measure same voltage of RED and GREEN output same as BLUE.</p>
									Open		
										GND	
5	Max. Output	$V_{do2}$									<p>(1) Adjust Brightness Control VR to get 3.0V at pin43 during trace period.</p> <p>(2) Apply Signal-2 and increase amplitude gradually from 0.</p> <p>(3) Read the amplitude of pin 43 when pin 59 voltage start to change.</p>
6	White Peak Limit Level	$V_{PL}$									<p>(1) Adjust Brightness Control VR to get 3.0V at pin43 during trace period.</p> <p>(2) Apply Signal-2 and increase amplitude gradually from 0.</p> <p>(3) Read the amplitude of pin 43 when pin 59 voltage start to change.</p>
7	White Peak Slice Level	$V_{PS}$									<p>(1) Adjust Brightness Control VR to get 3.0V at pin43 during trace period.</p> <p>(2) Apply Signal-2 and increase amplitude gradually from 0.</p> <p>(3) Measure the voltage of pin 43 clipped.</p>

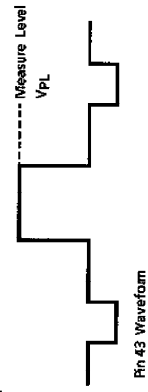
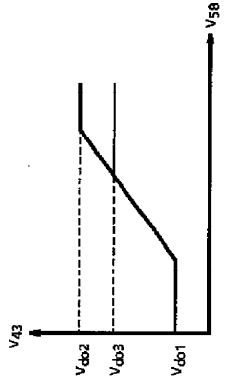

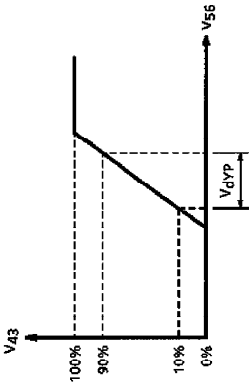
NOTE No.	ITEM	SYMBOL	SW & VR MODE					TEST METHOD	
			UNI-COLOR	SHARP-NESS	COLOR	BRIGHT-NESS	PIN 56		PIN 58
8	Dynamic Range Of 2 <sup>nd</sup> Order Differential Video Input	V <sub>dyp</sub>	Min.	Max.	Min.	Adj.	Input	AC GND	<p>(1) Adjust Brightness Control VR to get 3.0V at pin43 during trace period.</p> <p>(2) Measure the Voltage of pin46, and apply the voltage to pin 46.</p> <p>(3) Measure the Voltage of pin57, and apply the voltage to pin 57.</p> <p>(4) Vary the DC voltage of pin 56 to measure the dynamic range at pin 43.</p> <p>(5) Measure the DC voltage of pin 56 which gives the output voltage of 10% and 90% at pin 43 respectively.</p> 
9	AC Gain (Y)	GY	Max.	Min.			AC GND	Input	<p>(1) Adjust Brightness Control VR to get 3.0V at pin43 during trace period.</p> <p>(2) Apply 0.3V<sub>p-p</sub> Input signal-2 to pin 58.</p> <p>(3) Read the output signal at pin 43.</p> <p>(4) GY = V43 x 2</p>
10	Frequency Characteristic (Y)	FY		Max.					<p>(1) Adjust Brightness Control VR to get 3.0V at pin43 during trace period.</p> <p>(2) Apply 0.3V<sub>p-p</sub>/100kHz and 0.3V<sub>p-p</sub>/8MHz Signal-1 to pin 58.</p> <p>(3) Read the output signal at pin 43.</p> <p>(4) Measure the frequency of -3dB point.</p>

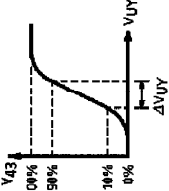
NOTE No.	ITEM	SYMBOL	SW & VR MODE						TEST METHOD
			UNI-COLOR Adj.	SHARPNESS Open	—	COLOR Min.	BRIGHTNESS Adj.	PIN.56 AC GND	
11	Uni-color Control Adjust Voltage Range (V)	$\Delta V_{UY}$							<p>(1) Adjust Brightness Control VR to get 3.0V at pin43 during trace period.</p> <p>(2) Apply 0.3V<sub>p-p</sub> Signal-2 to pin 58.</p> <p>(3) By changing Uni-color VR and measure the dynamic range at pin 43.</p> <p>Measure the dynamic range of Uni-color Control, Which give 100% and 90% at pin 43.</p> 
12	Gain Variation Range By Uni-color Adjustment (V)	$\Delta G_{UY}$							<p>(1) Adjust Brightness Control VR to get 3.0V at pin43 during trace period.</p> <p>(2) Apply 0.3V<sub>p-p</sub> Signal-2 to pin 58.</p> <p>(3) Read the output signal of Uni-color Min. (V43MIN) and Max. (V43MAX) at pin 43.</p> <p>(4) <math>\Delta G_{UY} = 20 \log (V43MAX / V43MIN)</math> (dB)</p>
13	Uni-color Adjustment Control Range (V)	$V_{UY}$							<p>(1) Adjust Brightness Control VR to get 3.0V at pin43 during trace period.</p> <p>(2) Apply 0.3V<sub>p-p</sub> Signal-2 to pin 58.</p> <p>(3) Read the output signal of Uni-color Min. (V43MIN) and Max. (V43MAX) at pin 43.</p> <p>(4) Measure the voltage at pin 59 which gives output of <math>(V43MAX + V43MIN) / 2</math> at pin 43.</p>

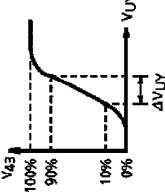
NOTE No.	ITEM	SYMBOL	SW & VR MODE					TEST METHOD	
			UNI-COLOR	SHARP-NESS	COLOR	BRIGHT-NESS	PIN 56		PIN 58
14	Uni-color Adjustment Control Range (U, V)	$V_{UC}$	Adj.	Open	Max.	Adj.	AC GND	AC GND	<ol style="list-style-type: none"> <li>Adjust Brightness Control VR to get 3.0V at pin 43 during trace period.</li> <li>Apply Signal-2 (0.1V<sub>p-p</sub>) to pin 62.</li> <li>Read the pin 43 output signal when set Uni-color VR Max. (V<sub>43MAX</sub>) and Min. (V<sub>43MIN</sub>).</li> <li>Measure pin 59 voltage which gives (V<sub>43MAX</sub> + V<sub>43MIN</sub>) / 2 to pin 43.</li> </ol>
15	Gain Variation Range By Uni-color Adjustment (U, V)	$\Delta GUC$							<ol style="list-style-type: none"> <li>Adjust Brightness Control VR to get 3.0V at pin 43 during trace period.</li> <li>Apply Signal-2 (0.1V<sub>p-p</sub>) to pin 62.</li> <li>Read the pin 43 output signal when set Uni-color VR Max. (V<sub>43MAX</sub>) and Min. (V<sub>43MIN</sub>).</li> <li><math>\Delta GUC = 20 \log (V_{43MAX} / V_{43MIN})</math> (dB)</li> </ol>
16	Uni-color Control Adjust Voltage Range (U, V)	$\Delta VUC$							<ol style="list-style-type: none"> <li>Adjust Brightness Control VR to get 3.0V at pin 43 during trace period.</li> <li>Apply Signal-2 (0.1V<sub>p-p</sub>) to pin 62.</li> <li>Calculate the difference voltage of pin 59 which gives 10% and 90% of pin 43 output signal.</li> <li>Measure the voltage at pin 59 which gives output of (V<sub>43MAX</sub> + V<sub>43MIN</sub>) / 2 at pin 43.</li> </ol> 
17	Gain Of Picture Sharpness Control	GPS	Max.	Max.	Min.		Input		<ol style="list-style-type: none"> <li>Adjust Brightness Control VR to get 3.0V at pin 43 during trace period.</li> <li>Apply Signal-3 30mV<sub>p-p</sub> to pin 56 through 10<math>\mu</math>F capacitor.</li> <li>Measure pin 43 signal output.</li> <li>Calculate Gain g.</li> <li><math>\Delta GPS = 20 \log (g / G_Y)</math> (dB)</li> </ol>

NOTE No.	ITEM	SYMBOL	SW & VR MODE					TEST METHOD	
			UNI-COLOR Max.	SHARPNESS Adj.	COLOR Min.	BRIGHTNESS Adj.	PIN 56		PIN 58
18	Picture Sharpness Control Range	$\Delta V_{\#55}$					Input and AC GND	Input and AC GND	<p>(1) Adjust Brightness Control VR to get 3.0V at pin 43 during trace period.</p> <p>(2) Apply Signal-1 (30mV signal during trace period and 10kHz) to pin 56 and pin 58 AC grounded.</p> <p>(3) Measure pin 55 Control Voltage which gives 90% level of pin 43 Output Voltage dynamic range.</p> <p>(4) Apply Signal-1 (0.3V, 2.4MHz) to pin 58 and pin 56 AC grounded.</p> <p>(5) Same as (3), measure pin 55 Control Voltage which gives 10% level of pin 43 Output dynamic range.</p> <p>(6) <math>\Delta V_{\#55} = V_{55}^H - V_{55}^L</math></p>

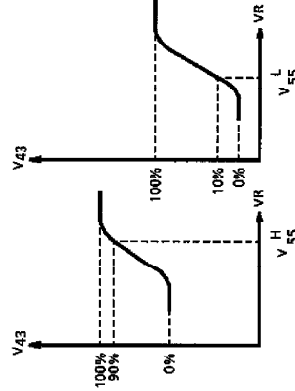



NOTE No.	ITEM	SYMBOL	SW & VR MODE					TEST METHOD		
			UNI-COLOR	SHARP-NESS	COLOR	BRIGHT-NESS	PIN 56		PIN 58	
19	Half Tone (Y)	$\Delta V_{3T1}$	Max.	Open	—	Min.	Adj.	AC GND	Input	(1) Adjust Brightness Control VR to get 3.0V at pin 43 during trace period. (2) Apply Signal-2 (0.3V <sub>pp</sub> ) to pin 58. (3) Measure pin 43 Output Voltage when applied 0V to pin 54. $V_{43}^1$ (4) Measure pin 43 Output Voltage when applied 1V to pin 54. $V_{43}^2$ (5) Measure pin 43 Output Voltage when applied 3V to pin 54. $V_{43}^3$ (6) $\Delta V_{3T1} = 20 \log (V_{43}^2 / V_{43}^1)$ (dB) (7) $\Delta V_{3T2} = 20 \log (V_{43}^3 / V_{43}^1)$ (dB)
		$\Delta V_{3T2}$								
20	Half Tone Switching Level (Y)	$-3dB S_W$			—					(1) Adjust Brightness Control VR to get 3.0V at pin 43 during trace period. (2) Apply Signal-2 (0.3V <sub>pp</sub> ) to pin 58. (3) Vary the pin 54 Control Voltage and measure the pin 54 voltage which give pin 43 output voltage down by 3dB. $\left( S_W^{-3dB} \right)$ (3) Vary the pin 54 Control Voltage and measure the pin 54 voltage which give pin 43 output voltage down by 6dB. $\left( S_W^{-6dB} \right)$
		$-6dB S_W$								
21		$A_{CL} S_W$								(1) Measurement conditions are same as Max. output (V <sub>do2</sub> ) of Note (5). (2) Decrease the pin 54 terminal voltage to get the pin 43 voltage is same as V <sub>do3</sub> . (3) Measure the pin 54 terminal voltage.

NOTE No.	ITEM	SYMBOL	SW & VR MODE					TEST METHOD	
			UNI-COLOR	SHARP-NESS	COLOR	BRIGHT-NESS	PIN 56		PIN 58
22	Half Tone (U, V)	$\Delta V_R-Y1$ $\Delta V_B-Y1$	Max.	Open	Max.	Adj.	AC GND	AC GND	(1) Set the Brightness Control VR to get 3.0V at pin 41 during trace period, (2) Apply Signal-2 (0.2V <sub>pp</sub> ) to pin 60. (3) Measure the pin 41 Output (V <sub>41</sub> <sup>1</sup> ) when applied 0V to pin 54. (4) Measure the pin 41 Output (V <sub>41</sub> <sup>2</sup> ) when applied 1V to pin 54. (5) Measure the pin 41 Output (V <sub>41</sub> <sup>3</sup> ) when applied 3V to pin 54. (6) $\Delta V_R-Y1 = 20 \log (V_{41}^2 / V_{41}^1)$ (dB) (7) $\Delta V_R-Y2 = 20 \log (V_{41}^3 / V_{41}^1)$ (dB) (8) Apply Signal, 0.1V <sub>pp</sub> , to pin 62. (9) As same as (3) measure pin 43 output (V <sub>43</sub> <sup>1</sup> ). (10) As same as (4) measure pin 43 output (V <sub>43</sub> <sup>2</sup> ). (11) As same as (5) measure pin 43 output (V <sub>43</sub> <sup>3</sup> ). (12) $\Delta V_B-Y1 = 20 \log (V_{43}^2 / V_{43}^1)$ (dB) (13) $\Delta V_B-Y2 = 20 \log (V_{43}^3 / V_{43}^1)$ (dB)
		$\Delta V_R-Y2$ $\Delta V_B-Y2$							

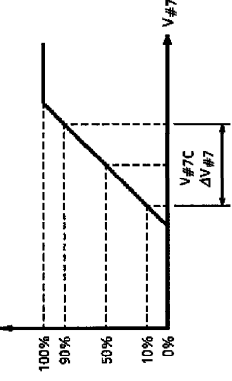
NOTE No.	ITEM	SYMBOL	SW & VR MODE				TEST METHOD
			UNI-COLOR	SHARPNESS	COLOR	BRIGHTNESS	
23	Color Control Variable Range	$\Delta V_{\#7}$	Max.	Open	Adj.	AC GND	<p>(1) Adjust Brightness Control VR to get 3.0V at pin43 during trace period.</p> <p>(2) Apply Signal-2 (0.1V<sub>p-p</sub>) to pin 62.</p> <p>(3) Changing Color VR and making Max. output (100%) and Min. output (0%), measure the color control variable range (<math>\Delta V_{\#7}</math>) which is the difference of color control voltage between 10% and 90% of its output.</p> 
		Color Control Center Voltage					
24	AC Gain (R-Y)	Gr-Y					<p>(4) Measure the color control center voltage (<math>V_{\#7C}</math>).</p> <p>(1) Adjust Brightness Control VR to get 3.0V at pin41 during trace period.</p> <p>(2) Apply Signal-2 (0.2V<sub>p-p</sub>) to pin 60.</p> <p>(3) Read the pin41 output signal (<math>V_{41}</math>).</p> <p>(4) <math>GR-Y = V_{41} / 0.2</math></p>
			Max.				
25	AC Gain (B-Y)	GB-Y					<p>(1) Adjust Brightness Control VR to get 3.0V at pin43 during trace period.</p> <p>(2) Apply Signal-2 (0.1V<sub>p-p</sub>) to pin 62.</p> <p>(3) Read the pin43 output signal (<math>V_{43}</math>).</p> <p>(4) <math>GR-Y = V_{43} / 0.1</math></p>

NOTE No.	ITEM	SYMBOL	SW & VR MODE						TEST METHOD	
			UNI-COLOR	SHARPNESS	COLOR	BRIGHTNESS	PIN 56	PIN 58		
26	Relative Amplitude (1) PAL/SECAM	G-Y R-Y	Max.	Open	—	Max.	Adj.	AC GND	AC GND	(1) Adjust Brightness Control VR to get 3.0V at pin43 during trace period. (2) Apply Signal-3 (0.2V <sub>p-p</sub> ) to pin 60. (3) Read the output signal at pin 42 (V <sub>42</sub> ). (4) G-G-Y = V <sub>42</sub> / 0.2 (5) G-Y/R-Y = - G-G-Y / G-R-Y
27		G-Y B-Y								(1) Adjust Brightness Control VR to get 3.0V at pin43 during trace period. (2) Apply Signal-3 (0.1V <sub>p-p</sub> ) to pin 62. (3) Read the output signal at pin 42 (V <sub>42</sub> ). (4) G'G-Y = V <sub>42</sub> / 0.1 (5) G-Y/B-Y = - G'G-Y / G'B-Y
28	Relative Amplitude (2) NTSC	G-Y R-Y			—					(1) Adjust Brightness Control VR to get 3.0V at pin43 during trace period. (2) Apply Signal-3 (0.2V <sub>p-p</sub> ) to pin 60. (3) Connect 10kΩ between pin22 (P-ident) and GND. (4) Read the output signal at pin 42 (V <sub>42</sub> ). (5) G-G-Y = V <sub>42</sub> / 0.2 (6) G-Y/R-Y = - G-G-Y / G-R-Y
29		G-Y B-Y								(1) Adjust Brightness Control VR to get 3.0V at pin43 during trace period. (2) Apply Signal-3 (0.1V <sub>p-p</sub> ) to pin 62. (3) Connect 10kΩ between pin22 (P-ident) and GND. (4) Read the output signal at pin 42 (V <sub>42</sub> ). (5) G'G-Y = V <sub>42</sub> / 0.1 (6) G-Y/B-Y = - G'G-Y / G'B-Y

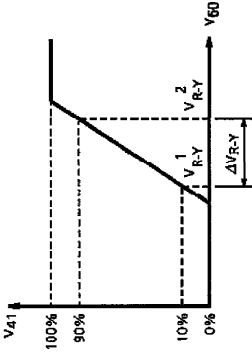
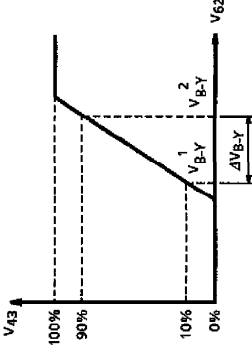
NOTE No.	ITEM	SYMBOL	SW & VR MODE					TEST METHOD		
			UNI-COLOR	SHARP-NESS	COLOR	BRIGHT-NESS	PIN 56		PIN 58	
30	Dynamic Range Of R-Y Input	$\Delta V_{R-Y}$	Min.	Open	—	Max.	Adj.	AC GND	AC GND	<p>(1) Set the Brightness Control VR to get 4.0V at pin 41 during trace period.</p> <p>(2) Measure pin 44 DC Voltage and apply it to pin 44.</p> <p>(3) Vary the pin 60 DC Voltage.</p> <p>(4) Measure pin 60 DC Voltage, which give DC Voltages of 90% (<math>V_{R-Y}^1</math>) and 10% (<math>V_{R-Y}^2</math>) to pin 41 of its Dynamic Range.</p> <p>(5) <math>\Delta V_{R-Y} = V_{R-Y}^1 - V_{R-Y}^2</math></p> 
31	Dynamic Range Of B-Y Input	$\Delta V_{B-Y}$	—	—	—	—	—	—	—	<p>(1) Set the Brightness Control VR to get 4.0V at pin 43 during trace period.</p> <p>(2) Measure pin 46 DC Voltage and apply it to pin 46.</p> <p>(3) Vary the pin 62 DC Voltage.</p> <p>(4) Measure pin 62 DC Voltage, which give DC Voltages of 90% (<math>V_{B-Y}^1</math>) and 10% (<math>V_{B-Y}^2</math>) to pin 43 of its Dynamic Range.</p> <p>(5) <math>\Delta V_{B-Y} = V_{B-Y}^1 - V_{B-Y}^2</math></p> 

TA8759BN - 37

NOTE No.	ITEM	SYMBOL	SW & VR MODE					TEST METHOD	
			UNI-COLOR	SHARP-NESS	COLOR	BRIGHT-NESS	PIN 56		PIN 58
32	Frequency Response Of Color Differential Signal	F <sub>D</sub>	Max.	Min.	Max.	Adj.	AC GND	AC GND	(1) Set the Brightness Control VR to get 3.0V at pin 43 during trace period. (2) Apply Signal-1 (0.1V, 100kHz/5MHz) to pin 62. (3) Measure the output signal at pin 43 (V <sub>43</sub> ). (4) Apply same signal as (2) to pin 60. (5) Measure the output at pin 41 (V <sub>41</sub> ) and pin 42 (V <sub>42</sub> ). (6) Measure the frequency of -3dB point.
33	Brightness Control Gain	G <sub>BR</sub>		Open					(1) Set the Brightness Control VR to get 3.0V at pin 43 during trace period. (2) Measure pin 43 voltage when increased Brightness control voltage by 1.0V during trace period (V <sub>#43</sub> ). (3) $G_{BR} = (V_{\#43} - 3.0) / 1.0$
34	Brightness Control Adjust Voltage	V <sub>#48</sub>							(1) Set the Brightness Control VR to get 3.0V at pin 43 during trace period. (2) Measure the pin 48 voltage (V <sub>#48</sub> ).
35	V.BLK Pulse Output Level	V <sub>VR</sub>							(1) Measure pin 41 V-Blanking pulse voltage (V <sub>VR</sub> ).
		V <sub>VG</sub>							(2) Measure pin 42 V-Blanking pulse voltage (V <sub>VG</sub> ).
		V <sub>VB</sub>							(3) Measure pin 43 V-Blanking pulse voltage (V <sub>VB</sub> ).
36	H.BLK Pulse Output Level	V <sub>HR</sub>							(1) Measure pin 41 H-Blanking pulse voltage (V <sub>HR</sub> ).
		V <sub>HG</sub>							(2) Measure pin 42 H-Blanking pulse voltage (V <sub>HG</sub> ).
		V <sub>HB</sub>							(3) Measure pin 43 H-Blanking pulse voltage (V <sub>HB</sub> ).

NOTE No.	ITEM	SYMBOL	SW & VR MODE				PIN 56	PIN 58	TEST METHOD
			UNI-COLOR Adj.	SHARP-NESS Open	COLOR Min.	BRIGHT-NESS Adj.			
37	DC Restoration Ratio	TDC	Adj.	Open	Min.	Adj.	Input	(1) Set the Brightness Control VR to get 3.0V at pin 43 during trace period. (2) Apply 3-step signal (a) to pin 58. (3) Adjust Uni-color VR so that amplitude of output signal (pin 43) is 1.25V. (4) Vary the APL of input signal from 10% to 90%. (5) Measure the variation of pedestal level ( $\Delta VP$ ) with APL change. (6) $TDC = (1 - \Delta VP) \times 100$ (%)	
38	Mute SW ON Level	V#555	Max.	Adj.	Max.			(1) Adjust the Brightness Control VR to get 3.0V at pin 43 during trace period. (2) Decreasing pin 55 voltage, read the pin 55 voltage (V#555) which causes pin 59 to start to change.	

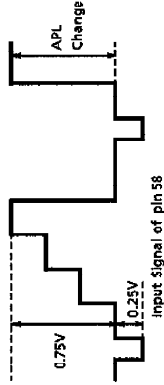

Note 39  
Input signal wave from of video stage

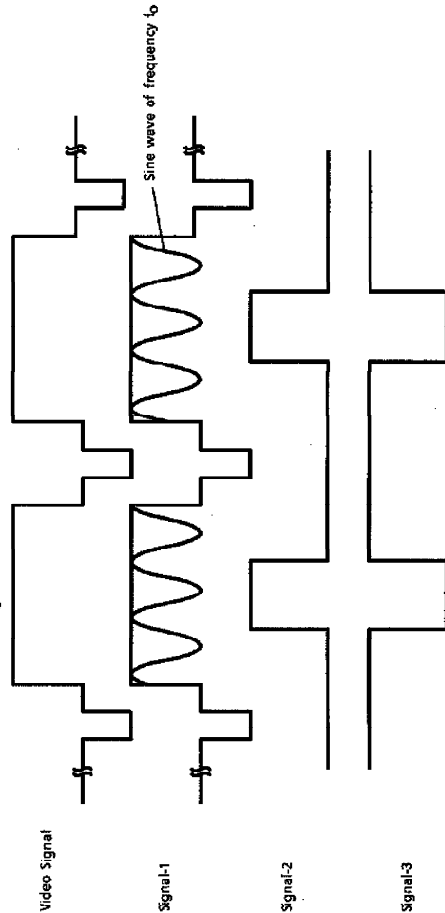

Data stage

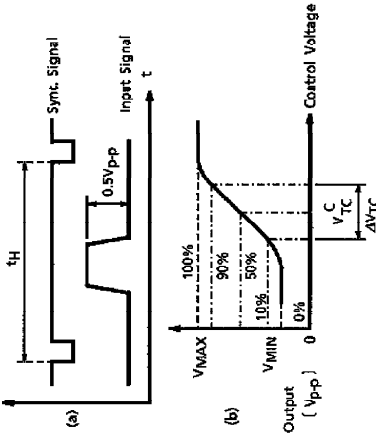
NOTE No.	ITEM	SYMBOL	DATA CONTRAST Adj.	SW & VR MODE				TEST METHOD
				S47	V53	COLOR	SHARPNESS	
40	Data Contrast Gain Variation Range	$\Delta GTC$	a ↓ b ↓ c	3V	Max.	Center	3V	<p>(1) Apply Fig. (a) signal to pin 47, and measure the output signal at pin 41.</p> <p>(2) Measure the DATA output signal level <math>V_{MAX}</math>, when DATA contrast maximum, and the <math>V_{MIN}</math> when DATA contrast minimum.</p> <p>Then calculate the DATA contrast gain variation range.</p> $\Delta GTC = 20 \log (V_{MAX} / V_{MIN})$ <p>(3) Calculate the DATA contrast control voltage range <math>\Delta V_{TC}</math> and DATA contrast center voltage <math>V_{TC}</math> as Fig. (b).</p> <p>(4) Repeat same procedure changing input to pin 49 (output pin 42) and pin 51 (output pin 43)</p> 
	Data Contrast Control Voltage Range	$\Delta V_{TC}$						
	Data Contrast Control Center Voltage	$V_{TC}^C$						
41	Input Dynamic Range	$V_{DI}$	Min.					<p>(1) Apply signal of Fig. (a) to pin 47, pin 49 and pin 51.</p> <p>(2) Increase the input signal and measure the input signal level when the output signal saturates to increase.</p> <p>(3) <math>V_{DI}</math> is the input signal level which gives 90% of the saturated output signal.</p> <p>Measure the DC voltage of pin 47 pin 49 and pin 51.</p>
42	Input Clamp Level	$V_{TIN}^{MIN}$						
43		$V_{TIN}^{MAX}$	Max.					

TA8759BN - 40



NOTE No.	ITEM	SYMBOL	SW & VR MODE					TEST METHOD		
			DATA CONTRAST	S47	V53	COLOR	SHARPNESS		V48	
44	Gain	G <sub>T</sub>	Max.	a ↓ b ↓ c	—	3V	Max.	Center	3V	<p>(1) Apply Signal of Fig. (a) to pin 47, pin 49 and pin 51 of note (40).</p> <p>(2) Measure the output V<sub>O</sub> at pin 41, pin 42 and pin 43.</p> <p>(3) G<sub>T</sub> = 20log (V<sub>O</sub>/0.5) dB</p>
	Rise Time	τ <sub>R</sub>								
	Propagation Time (Rising Edge)	tp <sub>R</sub>								
	Fall Time	τ <sub>F</sub>								
45	Propagation Time (Falling edge)	tp <sub>F</sub>								
	Data Input ON Level	V <sub>ON</sub> V <sub>TSW</sub>								
46	Data Input OFF Level	V <sub>OFF</sub> V <sub>TSW</sub>								<p>(1) Apply Signal of Fig. (a) of note (40) to pin 47.</p> <p>(2) Read the output signal (V<sub>O</sub>) at pin 41 when applied 5V to pin 53.</p> <p>(3) Increase V<sub>53</sub> from 0V, and measure the V<sub>53</sub> (V<sub>TSW</sub>) which gives pin 41 same voltage as V<sub>O</sub>.</p> <p>(4) Then decrease the V<sub>53</sub>, and measure the V<sub>53</sub> (V<sub>TSW</sub>) which gives pin 41 as 0V.</p>

NOTE No.	ITEM	SYMBOL	SW & VR MODE					TEST METHOD		
			DATA CONTRAST	S47	V53	COLOR	SHARPNESS		V48	
47	Video→Data Switching Time	t <sub>SVD</sub>	Max.	a ↓ b ↓ c	—	Adj.	—	Center	3V	<p>(1) Measure pin 47 voltage and apply pin 47 the voltage +0.5V.                      (2) Apply input signal of Fig. (a) to pin 53 and measure t<sub>SVD</sub> and t<sub>SDV</sub> in Fig. (b) at pin 41.                      (3) Measure same as (2) with pin 49, pin 42 and pin 51, pin 43.</p>
	Data→Video Switching Time	t <sub>SDV</sub>	—	—	—	—	—	—	—	
48	Cross Talk Data→Video	CTT				3V ↓ 0V				<p>(1) Apply sine wave of 1MHz, 0.5V<sub>p-p</sub> to pin 47.                      (2) Read pin 41 output signal (V<sub>41</sub>) when applied 3V to pin 53.                      (3) Measure maximum output (V<sub>O</sub>) among pin 41, pin 42 and pin 43 when applied 0V to pin 53.                      (4) 20log (V<sub>O</sub>/V<sub>#41</sub>)                      (5) Repeat same procedure changing input to pin 49 (output pin 42) and pin 51 (output pin 43).</p>
49	Cross Talk Video→Data	CTV				0V ↓ 3V				<p>(1) Apply sine wave of 1MHz, 0.5V<sub>p-p</sub> to pin 58. (Y)                      (2) Measure output (V<sub>OP</sub>) at pin 41, pin 42 and pin 43 when applied 0V to pin 53.                      (3) Measure the maximum output (V<sub>OC</sub>) level among pin 41, pin 42 and pin 43 when applied 3V to pin 53.                      (4) 20log (V<sub>OC</sub>/V<sub>OP</sub>)</p>

NOTE No.	ITEM	SYMBOL	SW & VR MODE					TEST METHOD
			DATA CONTRAST	S47	V53	COLOR	SHARPNESS	
50	Band Width Of Data	FT	Max.	a ↓ b ↓ c	3V	Max.	Center	(1) Apply sine wave signal (0.5V <sub>p-p</sub> , 500kHz) to pin47. (2) Measure the output level at pin41 (V <sub>41</sub> at 500kHz). (3) Vary the input frequency from 500kHz to 30MHz. (4) Measure the frequency when the output level is -30dB of V <sub>41</sub> at 500kHz. (5) Measure the -3dB frequencies at pin42 and pin43 with same manner. Measure the DC voltage of pin44, pin45 and pin46.
				d	0V			
51	Clamp Voltage	V44, V45, V46						Increase the height of the BLK pulse at pin35 from 0V to 5V and measure the threshold voltage of the BLK pulse when blanking outputs appear at the output terminals pin41, pin42 and pin43.
52	Blanking Input Threshold Voltage	V <sub>ON</sub> V <sub>BLK</sub>						Apply signal of Fig. (a) to pin35 and measure t <sub>ON</sub> and t <sub>OFF</sub> of the output signal at pin41, pin42 and pin43.
53	Blanking Pulse Delay Time	t <sub>ON</sub> dBP t <sub>OFF</sub> dBP						<p>(a) Applied signal to pin35 (Pi.BLK)</p> <p>(b) Output signal at pin41 (Foutp)</p>

Chroma stage

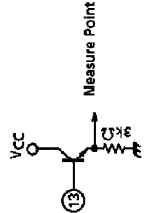
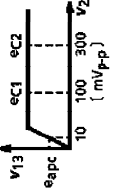
NOTE No.	ITEM	SYMBOL	SW & VR MODE								TEST METHOD	
			2 & 64	13	15	18	20	22	23	27		35
54	Chroma Amplitude	V13PC		OFF		C	B	A	B	A	A	<p>(1) Apply 100mV<sub>pp</sub> Burst/Chroma signal to pin 20 (Chroma : Burst= 1 : 1).</p> <p>(2) Color Mode</p> <p>(3) In case of PAL mode, connect pin 14 to VCC.</p> 
		V13nc 3.58						B				
55	ACC Characteristic	e <sub>apc</sub>										<p>(1) Apply 10mV<sub>pp</sub>, 100mV<sub>pp</sub> and 300mV<sub>pp</sub> Burst/Chroma signal to pin 20 (Chroma : Burst= 1 : 1).</p> <p>(2) Measure the output level at pin 13 for each input.</p> <p>(3) PAL Color Mode.</p> $A = \frac{eC2}{eC1}$ 
		A										
56	Delay Line Amp. Gain	V14PC		ON								<p>(1) Apply 100mV<sub>pp</sub> Burst/Chroma signal to pin 20 (Chroma : Burst= 1 : 1).</p> <p>Measure the output level of pin 14 (V14PC).</p> <p>(2) PAL Color Mode.</p> <p>(3) Measure the output of pin 14 when the capacitor of pin 13 (1μF) is removed and the line between pin 12 and pin 13 is opened.</p> $GDL = 20 \log \frac{V14PC}{V13PC}$ <p>(4) In the measurement of V14PC, connect pin 13 to VCC.</p>
		GDL		ON & OFF								

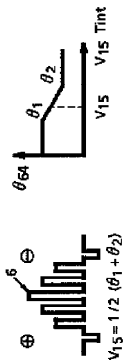
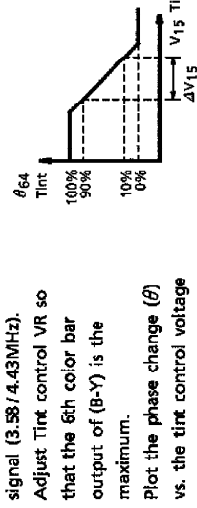
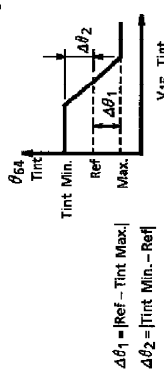
NOTE No.	ITEM	SYMBOL	SW & VR MODE								MEASUREMENT METHOD	
			2 & 64	13	15	18	20	22	23	27		35
57	Tint Control Voltage	V15 3.58n	ON	ON	Adj.	A	A	B or OFF	B or OFF	A or OFF	B	<p>(1) Apply Rainbow color bar signal (3.58/4.43MHz).</p> <p>(2) Adjust Tint control VR so that the 6th color bar output of (B-Y) is the maximum.</p> <p>(3) Plot the phase change (<math>\theta</math>) vs. the tint control voltage V15.</p> 
58	Tint Control Voltage Range	$\Delta V_{15}$ 3.58n										<p>(1) Apply Rainbow color bar signal (3.58/4.43MHz).</p> <p>(2) Adjust Tint control VR so that the 6th color bar output of (B-Y) is the maximum.</p> <p>(3) Plot the phase change (<math>\theta</math>) vs. the tint control voltage V15.</p> 
59	Tint Control Range	$\Delta \theta_{15}$ 3.58n $\Delta \theta_{15}$ 4.43n										<p>(1) Apply Rainbow color bar signal (3.58/4.43MHz).</p> <p>(2) Adjust Tint control VR so that the 6th color bar output of (B-Y) is the maximum.</p> <p>(3) Plot the phase change (<math>\theta</math>) vs. the tint control voltage V15.</p>
60	Tint Control Symmetry	$\Delta \theta_1$ 3.58n $\Delta \theta_1$ 4.43n $\Delta \theta_2$ 3.58n $\Delta \theta_2$ 4.43n										<p>(1) Apply Rainbow color bar signal (3.58/4.43MHz).</p> <p>(2) Adjust Tint control VR so that the 6th color bar output of (B-Y) is the maximum.</p> <p>(3) Plot the phase change (<math>\theta</math>) vs. the tint control voltage V15.</p>  <p><math>\Delta \theta_1 =  \text{Ref.} - \text{Tint Max.} </math> <math>\Delta \theta_2 =  \text{Tint Min.} - \text{Ref.} </math></p>

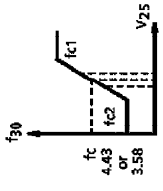
NOTE No.	ITEM	SYMBOL	SW & VR MODE								TEST METHOD	
			2 & 64	13	15	18	20	22	23	27		35
61	4.43 APC Pull In And Hold Range	f <sub>4PH</sub> f <sub>4PL</sub>	ON	ON	OFF	C	B	B	B	OFF	A	<p>(1) Apply 4.43MHz 0.1V<sub>p-p</sub> CW to pin 20.</p> <p>(2) Increase the CW frequency monitoring the wave shape of the terminal 25 with synoscope.</p> <p>(3) Measure the CW frequency of f<sub>4H</sub> when the terminal 25 wave shape changes from DC to sweeping.</p> <p>(4) Then, decrease the CW frequency of f<sub>4H</sub> when the terminal 25 wave shape changes from sweeping to DC.</p> <p>(5) Continue to decrease the CW frequency and measure the frequency of f<sub>4L</sub> when the terminal 25 wave shape changes from DC to sweeping again.</p> <p>(6) Then increase the CW frequency and measure the frequency of f<sub>4L</sub> when the terminal 25 wave shape changes from sweeping to DC.</p>
		f <sub>4HH</sub> f <sub>4HL</sub>										
62	3.58 APC Pull In And Hold Range	f <sub>3PH</sub> f <sub>3PL</sub>										<p>(1) Apply 3.58MHz 0.1V<sub>p-p</sub> CW to pin 20.</p> <p>(2) Measure f<sub>3H</sub>, f<sub>3H</sub>, f<sub>3L</sub>, and f<sub>3L</sub> same as note (61).</p>
		f <sub>3HH</sub> f <sub>3HL</sub>										
63	Frequency Control Sensitivity	β <sub>4.4</sub>				C		A		A	<p>(1) PAL Mode</p> <p>(2) Apply DC voltage to pin 25.</p> <p>Adjust the DC voltage so that pin 30 frequency is equal to f<sub>5C</sub> (4.43 or 3.58MHz sub-carrier frequency).</p> <p>Then change the DC voltage by ±20mV and measure the pin 30 frequency f<sub>c1</sub> and f<sub>c2</sub>.</p> $\beta_{4.4} = \frac{(f_{c1} - f_{c2})}{40}$	
		β <sub>3.5</sub>						B				 <p>(Note) in the measurement, use a Low Pass Filter</p>
64												<p>(1) 3.58NTSC Mode</p> <p>(2) Apply DC voltage to pin 25.</p> <p>Adjust the DC voltage so that pin 30 frequency is equal to f<sub>5C</sub> (4.43 or 3.58MHz sub-carrier frequency).</p> <p>Then change the DC voltage by ±20mV and measure the pin 30 frequency f<sub>c1</sub> and f<sub>c2</sub>.</p> $\beta_{3.5} = \frac{(f_{c1} - f_{c2})}{40}$

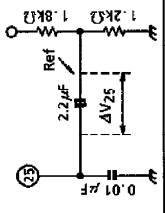
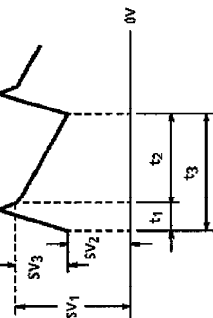
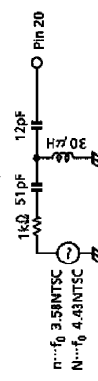
NOTE No.	ITEM	SYMBOL	SW & VR MODE								TEST METHOD		
			2 & 64	13	15	18	20	22	23	27		35	
65	APC Pull In Voltage	$\Delta V_{25-4}$	ON	ON	OFF	C	B	OFF	B	B	OFF	A	<p>(1) Apply Burst signal (100mV<sub>p-p</sub>, 4.43/3.58) to pin 20.</p> 
		$\Delta V_{25-3}$	ON	ON	OFF	C	B	OFF	B	B	OFF	A	
66	APC Pull In Sweep Amplitude	SV1	ON	ON	OFF	C	B	OFF	B	B	OFF	A	<p>(1) B/W Mode (2) Measure pin 25 terminal wave from.</p> 
		SV2	ON	ON	OFF	C	B	OFF	B	B	OFF	A	
		SV3	ON	ON	OFF	C	B	OFF	B	B	OFF	A	
67	APC Pull In Sweep Period	t1	ON	ON	OFF	C	B	OFF	B	B	OFF	A	<p>(1) Apply Rainbow color bar signal. (2) In case for NTSC, change chroma band pass filter as ;</p> 
		t2	ON	ON	OFF	C	B	OFF	B	B	OFF	A	
		t3	ON	ON	OFF	C	B	OFF	B	B	OFF	A	
68	Color Difference Output	V2PR	ON	ON	OFF	C	B	OFF	B	B	OFF	A	<p>Calculate the ratio of (R-Y) and (B-Y) output signal. The test condition is same as Note (67).</p>
		V64PB	ON	ON	OFF	C	B	OFF	B	B	OFF	A	
		V2nR	ON	ON	OFF	C	B	OFF	B	B	OFF	A	
		V64nB	ON	ON	OFF	C	B	OFF	B	B	OFF	A	
		V64nB	ON	ON	OFF	C	B	OFF	B	B	OFF	A	
		V2PR	ON	ON	OFF	C	B	OFF	B	B	OFF	A	
68	Relative Amplitude	V64PB	ON	ON	OFF	C	B	OFF	B	B	OFF	A	
		V64nB	ON	ON	OFF	C	B	OFF	B	B	OFF	A	

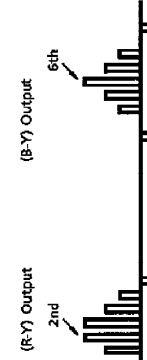
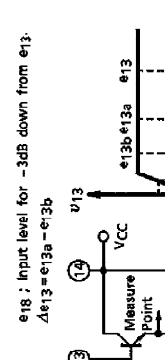
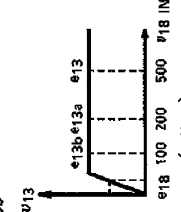
NOTE No.	ITEM	SYMBOL	SW & VR MODE								TEST METHOD	
			2 & 64	13	15	18	20	22	23	27		35
69	Relative Phase	$\theta_{2PR}$	ON	ON	Adj.	A	A	B or OFF	A or OFF	B or OFF	B	<p>(1) The test condition is same as Note (67).</p> <p>(2) Adjust Tint control VR so that the 6th color bar output of (B-Y) is the maximum.</p> <p>(3) Measure phase difference between (R-Y) output and (B-Y) output.</p> 
		$\theta_{2NR}$ $\theta_{2NR}$										
70	Characteristics Of SECAM Limiter	e1	OFF	OFF		B	C	B	A or OFF	A	A	<p>(1) Connect pin 14 to VCC.</p> <p>(2) Apply 4.4MHz CW to pin 18. Vary the input level, then measure the output level at pin 13 through Emitter follower.</p> <p>(3) SECAM Mode</p>  <p><math>e_{18}</math> : Input level for -3dB down from <math>e_{13}</math>. <math>\Delta e_{13} = e_{13a} - e_{13b}</math></p> 
		e13										
		$\Delta e_{13}$										
71	SECAM Color Difference Output	V23R V645B	ON			A	A	B or OFF	A or OFF	B or OFF	B	<p>(1) Apply 75% SECAM standard color bar signal.</p> <p>(Note) Before measurement, the 1H delay line should be adjusted with PAL Philips pattern signal.</p>
		V25 V64S	OFF & ON			B	C	B	B	B	A or OFF	
72	SECAM Relative Amplitude	V25 V64S	OFF & ON									<p>(1) Apply FM 100kHz deviation, fm 1kHz, 100dB<math>\mu</math>V signal to pin 18.</p> <p>(2) FOR = 4.406MHz, fOB = 4.25MHz</p> <p>(3) H.Pulse is not applied to pin 35.</p> <p>(4) SECAM Mode</p> <p>(Note) Before measurement, the B-Y, R-Y outputs offset should be removed by adjusting demodulator coils.</p>



NOTE No.	ITEM	SYMBOL	SW & VR MODE								TEST METHOD	
			2 & 64	13	15	—	20	22	27	35		
73	Band Width Of SECAM Demodulated Signal	2B 64B	ON	OFF & ON	OFF	B	C	B	A or OFF	B	A & OFF	<p>(1) Apply FM 100kHz deviation, fm 1kHz, 100dB, <math>\mu</math>V signal to pin 18.</p> <p>Vary the frequencies of FOB and FOR.</p> <p>Measure -3dB band width at color difference signal outputs.</p> <p>(2) FOR = 4.406MHz, FOB = 4.25MHz</p> <p>(3) H.Pulse is not applied to pin 35.</p> <p>(4) SECAM Mode</p> <p>(Note) Before measurement, the B-Y, R-Y outputs offset should be removed by adjusting demodulator coils.</p>
74	SECAM Cross Talk	RC BC	ON			A	A	B or OFF		B or OFF	B	<p>(1) Apply 75% SECAM standard color bar signal to pin 18.</p> <p>(2) Measure V2E the amplitude of the beat signal (FOR - FOB).</p> <p>(3) Measure V2SR demodulated color signal amplitude.</p> <p><math>RC = 20 \log \frac{V2E}{V2SR}</math></p> <p>(Note) Before measurement, the 1H delay line should be adjusted with PAL Philips pattern signal.</p>
75	50/60 Detection	V18 50 V18 60				C					A or OFF B or OFF	<p>(1) Measure DC voltage at pin 18.</p> <p>V18 50 ..... PAL receiving</p> <p>V18 60 ..... NTSC receiving</p>

NOTE No.	ITEM	SYMBOL	SW & VR MODE								TEST METHOD	
			2 & 64	13	15	18	20	22	23	27		35
76	Ident Input Level	Pin B/W	ON	ON	—	C	A	OFF	B	OFF	A	<p>(1) Apply 40mV<sub>p-p</sub> (0dB) burst signal to pin 20 through an attenuator, chroma take off coil and Emitter follower.</p> <p>(2) Decrease the input level and measure the amplitude when killer operates.</p> <p>(Note) In the measurement, remove the probe.</p>
		NIN B/W	ON	OFF	OFF	B	C	B	OFF	B	B	
		SIN B/W	ON	OFF	OFF	B	C	OFF	B	OFF	B	
77		Pin COLOR	ON	ON	—	C	A	OFF	B	OFF	A	<p>(1) Apply fOB, fOR of 40mV<sub>p-p</sub> signals to pin 18.</p> <p>(2) Measure the amplitude when Color Killer operates.</p> <p>(Test Circuit) Bell filter : OFF Pre-emphasis : ON</p>
		NIN COLOR	ON	OFF	OFF	B	C	B	OFF	B	B	
		SIN COLOR	ON	OFF	OFF	B	C	OFF	B	OFF	B	
78		Pin COLOR	ON	ON	—	C	A	OFF	B	OFF	A	<p>(1) Test condition is same as note (76).</p> <p>(2) Attenuate the input burst level up to killer operating level. Then increase the input burst level and measure the amplitude when the color appears.</p>
		NIN COLOR	ON	OFF	OFF	B	C	B	OFF	B	B	
		SIN COLOR	ON	OFF	OFF	B	C	OFF	B	OFF	B	
79		Pin COLOR	ON	ON	—	C	A	OFF	B	OFF	A	<p>(1) Test condition is same as note (77).</p> <p>(2) Attenuate the input burst level up to killer operating level. Then increase the input burst level and measure the amplitude when the color appears.</p>
		NIN COLOR	ON	OFF	OFF	B	C	B	OFF	B	B	
		SIN COLOR	ON	OFF	OFF	B	C	OFF	B	OFF	B	

NOTE No.	ITEM	SYMBOL	SW & VR MODE								TEST METHOD		
			2 & 64	13	15	18	20	22	23	27		35	
80	Ident. Voltage	PC PS	ON	ON		C	A	OFF & Adj.	B	B	OFF A & Adj.	A	<p>Change the Chroma and take off coil as follows ;</p> <p>(a) Connect pin27 to VCC through 10kΩ. Apply DC voltage to pin 22. Vary the DC voltage from 7V to 5V monitoring the terminal 25 with synchroscope, and measure the voltage (PC) when killer works.</p> <p>(b) Apply DC voltage to pin 22 and pin 27 simultaneously. Vary the DC voltage from 7V to 5V monitoring the terminal 25 with synchroscope and measure the DC voltage (PS) when pin 25 starts sweeping.</p>
			OFF	OFF	OFF			B	OFF & Adj.	OFF & Adj.	OFF & Adj.		
81		NC NS			OFF								<p>Connect the input resistor of the Bell filter to GND.</p> <p>Apply DC voltage to pin 23. Vary the DC voltage from 7V to 5V monitoring the terminal 25 with synchroscope, and measure the voltage (SC) when killer works.</p>
82		SC				B	C		OFF & ON Adj.	B			

TA8759BN - 51

Deflection stage

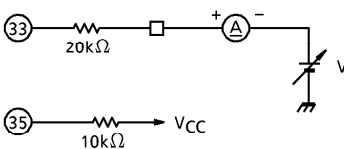
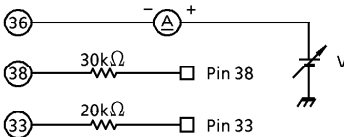
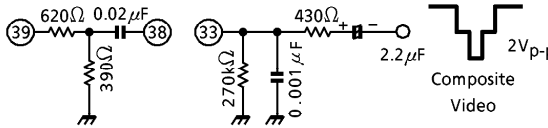
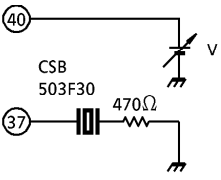
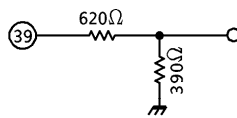
NOTE No.	ITEM	SYMBOL	TEST METHOD
83	Sync. Separation Input Current Sensitivity	$I_{IN33}$	 <p>Adjust an external DC voltage (V). Read the current (A) when the terminal voltage of pin 35 changes from Low to High.</p>
84	H. AFC Phase Detection Current	$I_{DET}$	 <p>Connect pin 38 to GND through 30kΩ. Adjust an external DC voltage (V) so that no current flows. Measure the current with connecting pin 33 to GND through 20kΩ.</p>
85	Phase Detection Masked Period	$T_{CO60}$ $T_{CO50}$	 <p>Apply Composite video signal to pin 33 through sync. sep. filter. Monitor pin 36 waveform and measure the V-mask period.  <math>T_{CO60} \dots (60\text{Hz})</math>    <math>T_{CO50} \dots (50\text{Hz})</math></p>
86	32f <sub>H</sub> VCO Oscillation Stage Voltage	$V_{ON37}$	 <p>Apply an external DC voltage (V) to pin 40. Monitor pin 37 waveform through 0.01μF capacitor. Increase the DC voltage (V) from 0 to 9V. Measure the DC voltage of pin 40 when the oscillation signal of pin 37 appears. <math>V_{CC}</math> (12V) is not applied. (Note) Use a high-impedance probe.</p>
87	Horizontal Output Start Voltage	$V_{ON39}$	 <p>Same as note (86). Measure the DC voltage of pin 40 when the H.Pulse appears.</p>
88	Horizontal Free Running Frequency	$f_0$	Measure the frequency at pin 39.

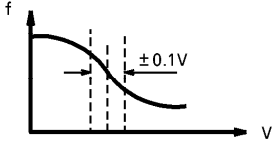
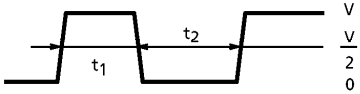
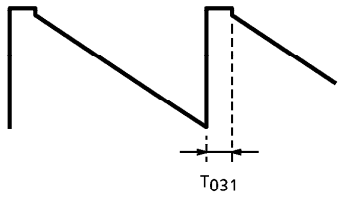
NOTE No.	ITEM	SYMBOL	TEST METHOD
89	Horizontal Frequency Oscillation Range	f <sub>MAX.</sub>	Connect pin 36 to GND through 30kΩ. Measure the frequency at pin 39.
		f <sub>MIN.</sub>	Connect pin 36 to H.V <sub>CC</sub> through 10kΩ. Measure the frequency at pin 39.
90	Horizontal Frequency Control Sensitivity	β <sub>H</sub>	<p>Measure the open terminal voltage at pin 36 (V<sub>36</sub>). Apply an external DC voltage of V<sub>36</sub> ± 0.1V and measure pin 39 frequency variation.</p> 
91	Horizontal Output Duty Ratio	T <sub>039</sub>	<p>Measure t<sub>1</sub> and t<sub>2</sub> by monitoring pin 39 waveform with a synchroscope.</p>  $T_{039} = \frac{t_1}{t_1 + t_2} \times 100 (\%)$
92	X-ray Protection Threshold Voltage	V <sub>I52</sub>	Apply an external DC voltage (V) to pin 52. Increase the DC voltage. Measure the DC voltage of pin 52 when the output pulse of pin 39 disappears.
93	X-ray Protection Hold Voltage	V <sub>H52</sub>	H.V <sub>CC</sub> = 9V. Apply an external DC voltage (V) to pin 52 so that H.Pulse at pin 39 disappears. Then set H.V <sub>CC</sub> = 2.5V. Check the H.Pulse at pin 39 still disappears when H.V <sub>CC</sub> is set 9V again.
94	X-ray Protector Current Sensitivity	I <sub>i52</sub>	Apply an external DC voltage (V) to pin 52. Increase the DC voltage. Measure the current when pin 39 is Low.
95	Horizontal Output Voltage	V <sub>H39</sub>	Measure the high level of pin 39 waveform (V <sub>H39</sub> ).
		V <sub>L39</sub>	Measure the low level of pin 39 waveform (V <sub>L39</sub> ).
96	Vertical Output Pulse Width	T <sub>031</sub>	<p>Measure the high state period of pin 31 waveform.</p> 

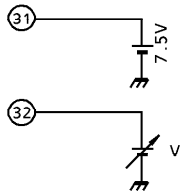
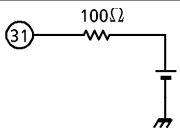
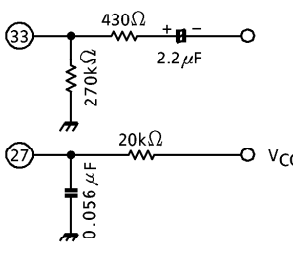
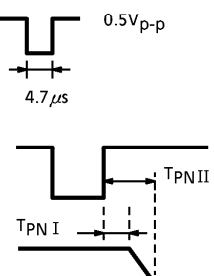
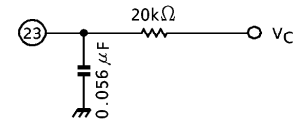
NOTE No.	ITEM	SYMBOL	TEST METHOD
97	Vertical Amplifier Gain	$G_V$	 <p>Apply an external DC voltage (V) to pin 32. Vary the external DC voltage from 7.4V to 7.6V. Measure the voltage change at pin 29.</p>
98	Vertical Output Dynamic Range	$V_{H29}$	Test condition is same as note (97). Measure the DC voltage at pin 29 when the external DC voltage of pin 32 is set to 6.5V.
		$V_{L29}$	Test condition is same as note (97). Measure the DC voltage at pin 29 when the external DC voltage of pin 32 is set to 8.5V.
99	Max. Output Current Of Vertical Ramp Generator	$I_{MAX31}$	 <p>Monitor the waveform of pin 31. Measure the current of ramp period.</p>
100	Pull In Range Of Vertical Oscillator	$V_{pull}$	Vary the vertical sync. period of the input composite signal. Test condition is same as note (85). Measure the vertical period when the vertical output pulse at pin 31 synchronizes to the input V sync. period.
101	60Hz Detector Ident Range	$V_{pull\ 60}$	Test condition is same as note (100). Measure vertical period when the DC voltage at pin 18 is approximately 7.3V.
102	Vertical Blanking Pulse Width	$T_{B60}$	Measure the vertical blanking width at RGB outputs. Vertical frequency of input signal is 60Hz.
		$T_{B50}$	Measure the vertical blanking width at RGB outputs. Vertical frequency of input signal is 50Hz.
103	Phase Of Gate Pulse NTSC/PAL	$T_{PN\ I}$	  <p>Measure the <math>T_{PN\ I}</math> and <math>T_{PN\ II}</math> at pin 27 with a synchroscope.</p>
		$T_{PN\ II}$	
104	Phase Of Gate Pulse SECAM	$T_{S\ I}$	 <p>Measure the <math>T_{S\ I}</math> and <math>T_{S\ II}</math> at pin 23 with a synchroscope.</p>
		$T_{S\ II}$	

TEST CIRCUIT 1  
DC characteristics

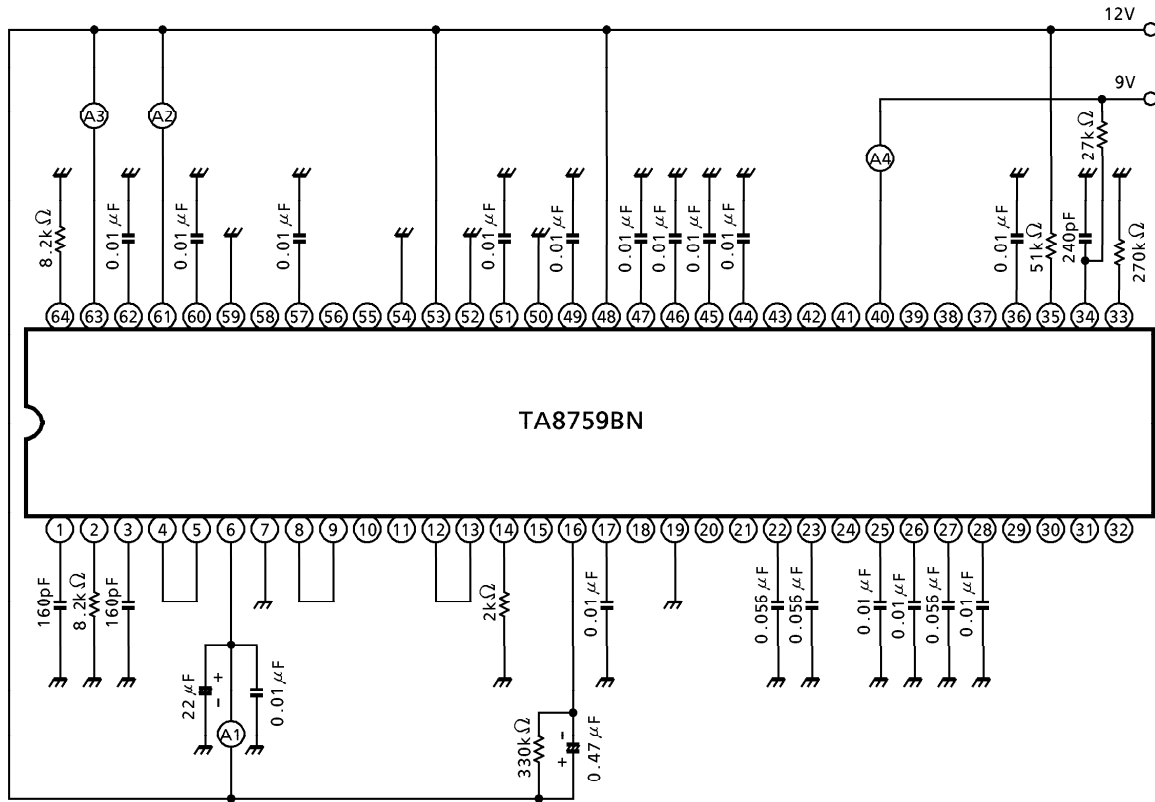

TEST CIRCUIT 2  
AC characteristics

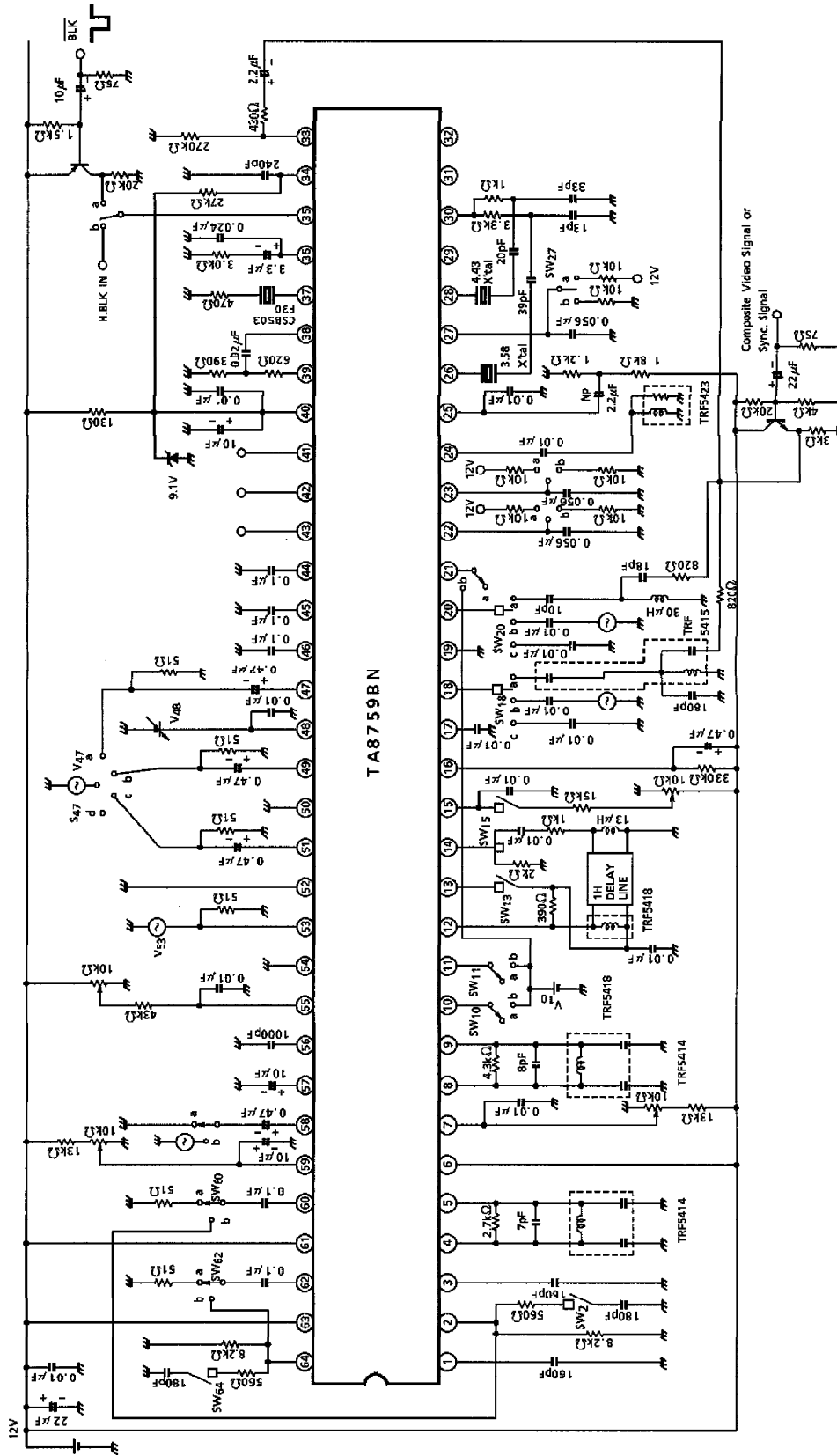



APPLICATION CIRCUIT

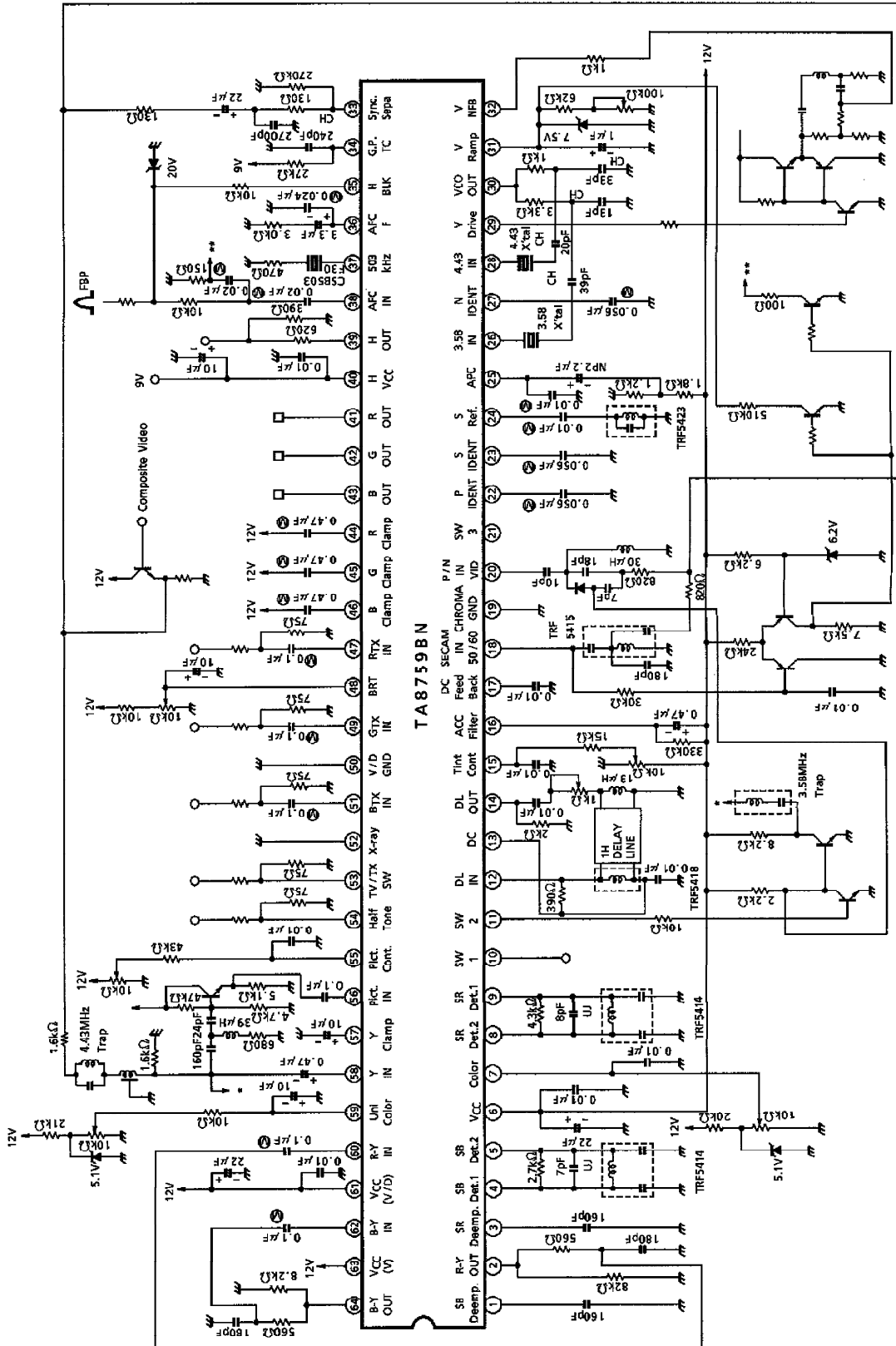

⊙ : Film Capacitor

TA8759BN - 57

OUTLINE DRAWING  
SDIP64 -P-750-1.78

Unit : mm

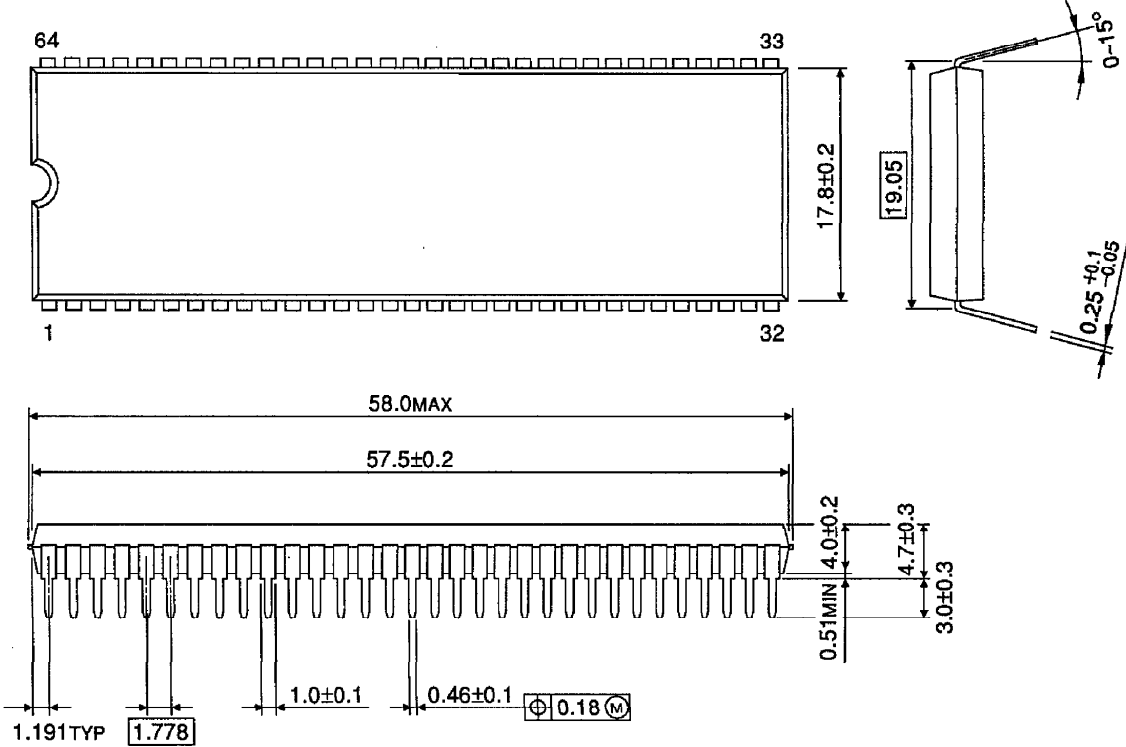

Weight : 8.85g (Typ.)