

IF AMPLIFIER WITH DEMODULATOR AND AFC

- SUPPLY VOLTAGE : 12V TYP
- SUPPLY CURRENT : 50mA TYP
- I.F. INPUT VOLTAGE SENSITIVITY AT $F = 38.9\text{MHz}$: $85\mu\text{V}_{\text{RMS}}$ TYP
- VIDEO OUTPUT VOLTAGE (white at 10% of top synchro) : 2.7V_{PP} TYP
- I.F. VOLTAGE GAIN CONTROL RANGE : 64dB TYP
- SIGNAL TO NOISE RATIO AT $V_i = 10\text{mV}$: 58dB TYP
- A.F.C. OUTPUT VOLTAGE SWING FOR $\Delta f = 100\text{kHz}$: 10V TYP

DESCRIPTION

The TDA2540 and 2541 are IF amplifier and A.M. demodulator circuits for colour and black and white television receivers using PNP or NPN tuners. They are intended for reception of negative or positive modulation CCIR standard.

They incorporate the following functions :

- Gain controlled amplifier
- Synchronous demodulator
- White spot inverter
- Video preamplifier with noise protection
- Switchable AFC
- AGC with noise gating
- Tuner AGC output (NPN tuner for 2540)-(PNP tuner for 2541)
- VCR switch for video output inhibition (VCR play back)

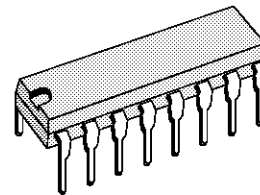

DIP16
(Plastic Package)

ORDER CODE : TDA2540-TDA2541

PIN CONNECTIONS

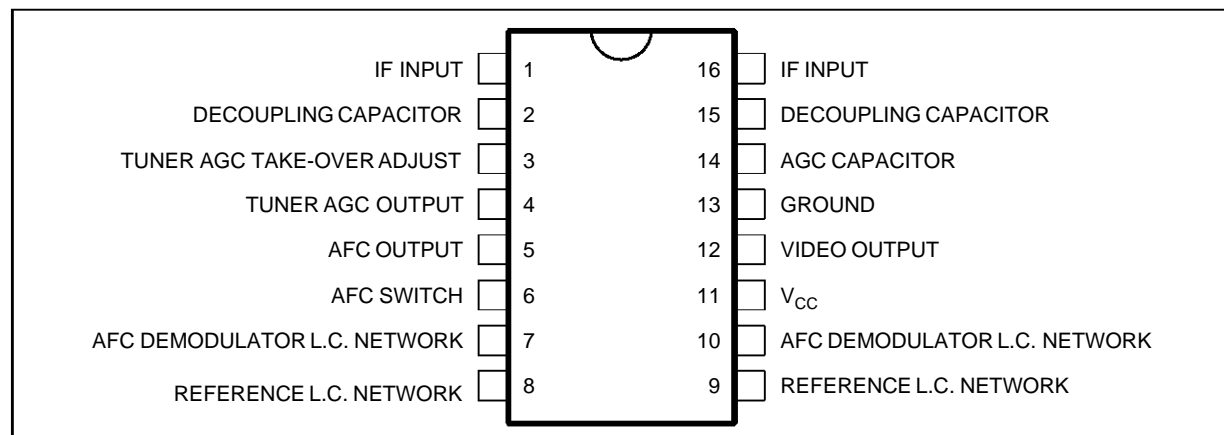

2540-01.EPS

TDA2540 - TDA2541

BLOCK DIAGRAM

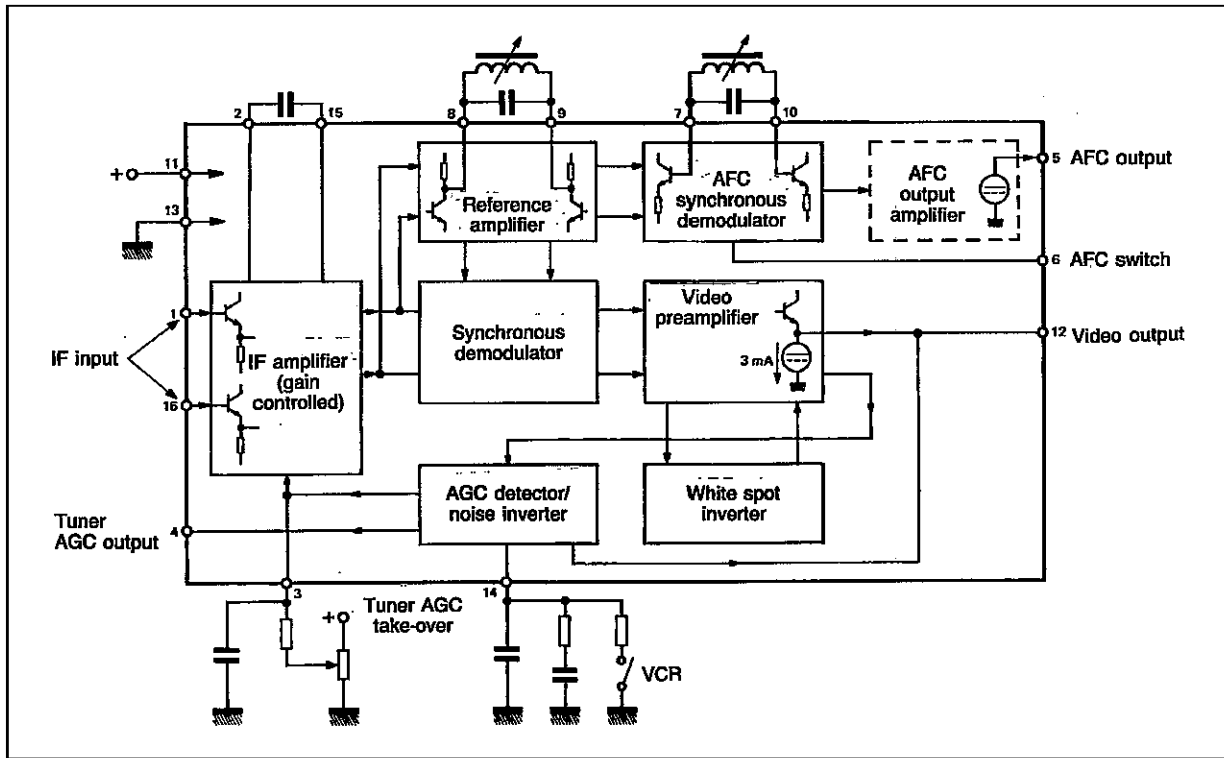

ABSOLUTE MAXIMUM RATINGS

| Symbol | Parameter | Value | Unit |
|------------------|-------------------------------|---------------|------|
| V (11-13) | Supply Voltage | 13.8 | V |
| V (4-13) | Tuner A.G.C. Voltage | 12 | V |
| P _{tot} | Power Dissipation | 900 | mW |
| T _{stg} | Storage Temperature | - 55 to + 125 | °C |
| T _{amb} | Operating Ambient Temperature | 0 to + 70 | °C |

THERMAL DATA

| Symbol | Parameter | Value | Unit |
|-----------------------|---------------------------------------|-------|------|
| R _{th (j-a)} | Junction - ambient Thermal Resistance | 70 | °C/W |

ELECTRICAL OPERATING CHARACTERISTICS

T_{amb} = 25°C ; V₁₁₋₁₃ = 12V; f = 38.9MHz (unless otherwise specified)

| Symbol | Parameter | Min. | Typ. | Max. | Unit |
|--------------------|---|------|------|------|-------------------|
| V ₁₁₋₁₃ | Supply Voltage Range | 10.2 | 12 | 13.8 | V |
| I ₁₁ | Supply Current | | 50 | 60 | mA |
| V ₁₋₁₆ | IF Input Voltage Sensitivity | 60 | 85 | 180 | μV _{RMS} |
| | Max Input Voltage (Pins 1-16) | | 140 | | mV |
| V ₁₂₋₁₃ | Video Output Voltage | | 2.7 | | V _{pp} |
| Z ₁₋₁₆ | Differential Input Impedance (in parallel with 2pF) | | 2 | | kΩ |
| V ₁₂₋₁₃ | Zero Signal Output Level | 5.7 | 6 | 6.3 | V |
| V ₁₂₋₁₃ | Top Synchro Output Level | 2.9 | 3.07 | 3.2 | V |
| ΔG _V | IF Voltage Gain Control Range | 52 | 64 | | dB |

ELECTRICAL OPERATING CHARACTERISTICS (continued)

T_{amb} = 25 °C; V (11 – 13) = 12 V; f = 38.9 MHz (unless otherwise specified)

| Symbol | Parameter | Min. | Typ. | Max. | Unit |
|--------------------|---|------|---------|------|-------------------|
| S/N | Signal to Noise Ratio (V _i = 10mV) (see note 1) | 50 | 58 | | dB |
| B | Bandwidth of Video Amplifier (– 3dB) | | 6 | | MHz |
| dG | Differential Gain | | 4 | 10 | % |
| dφ | Differential Phase | | 2 | 10 | % |
| V ₁₂₋₁₃ | Carrier Signal at Video Output (V _i = 10mV) | | 4 | 30 | mV _{RMS} |
| V ₁₂₋₁₃ | 2nd Harmonic of Carrier at Video Output (V _i = 10mV) | | 20 | 30 | mV _{RMS} |
| | Intermodulation at 1.1MHz (blue) (see Figures 2 and 3) | 46 | 60 | | dB |
| | Intermodulation at 1.1MHz (yellow) (see Figures 2 and 3) | 46 | 50 | | dB |
| | Intermodulation at 3.3MHz (blue) (see Figures 2 and 3) | 46 | 54 | | dB |
| V ₁₄₋₁₃ | VCR Switches Off Output at : (VCR = low Level) | | | 1.1 | V |
| | White Spot Inverter Threshold Level (see Figure 1) | | 6.6 | | V |
| | White Spot Insertion Level (see Figure 1) | | 4.7 | | V |
| | Noise Inverter Threshold Level (see Figure 1) | | 1.8 | | V |
| | Noise Insertion Level (see Figure 1) | | 3.8 | | V |
| I ₄ | Tuner AGC output Current Range | | 0 to 10 | | mA |
| V ₁₄₋₁₃ | Tuner AGC Output Voltage | | | 0.3 | V |
| I ₄ | Tuner AGC Output Leakage Current TDA2541 V ₁₄₋₁₃ = 11V, V ₄₋₁₃ = 12V TDA2540 V ₁₄₋₁₃ = 5V, V ₄₋₁₃ = 12V | | | 15 | μA |
| ΔV ₅₋₁₃ | AFC Output Voltage Swing (Δf = 100 kHz) | 10 | 11 | | V |
| Δf | Change of Frequency at AFC Output (voltage swing of 10V) | | 100 | 200 | kHz |
| V ₆₋₁₃ | AFC Switches OFF (AFC = low level) at : | | | 2.5 | V |
| V ₆₋₁₃ | AFC Switches LOW (AFC = High level) at : | 3.2 | | | V |
| V ₅₋₁₃ | AFC Zero = Signal Output Voltage (minimum gain) | 4 | 6 | 8 | V |

Note : 1. $\frac{S}{N} = \frac{V_o \text{ (black to white)}}{V_N \cdot (\text{RMS at } B = 5\text{MHz})}$ (dB)

Figure 1 : Video Output Waveform Showing White Spot and Noise Inverter Threshold Levels

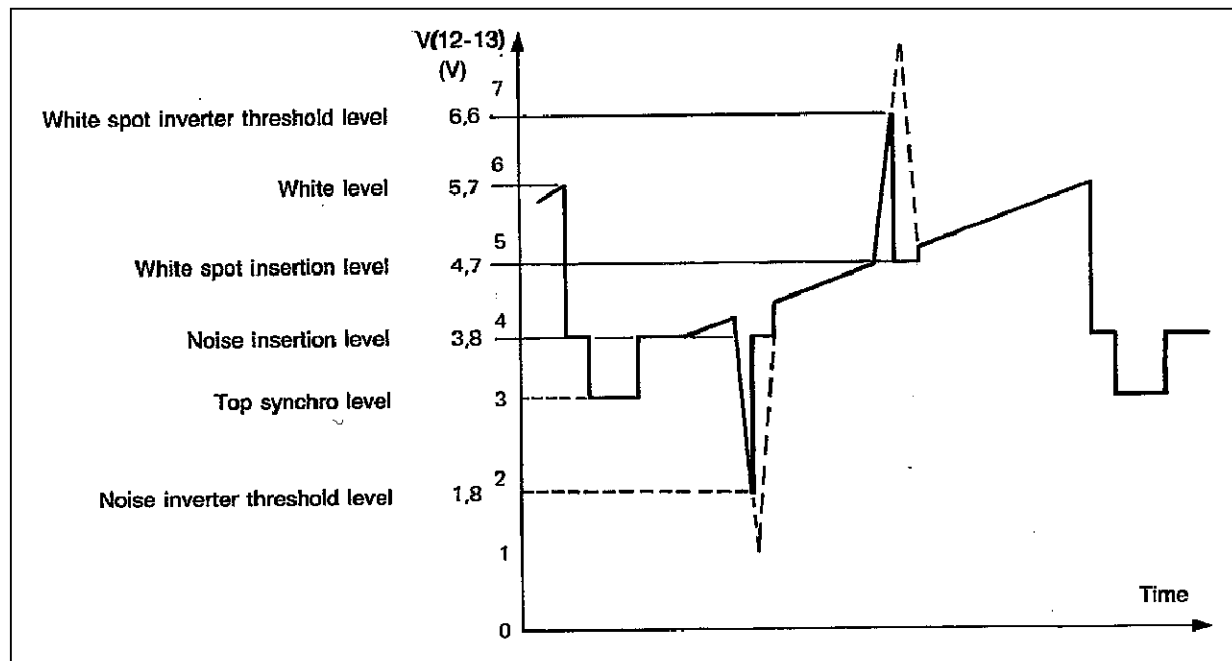
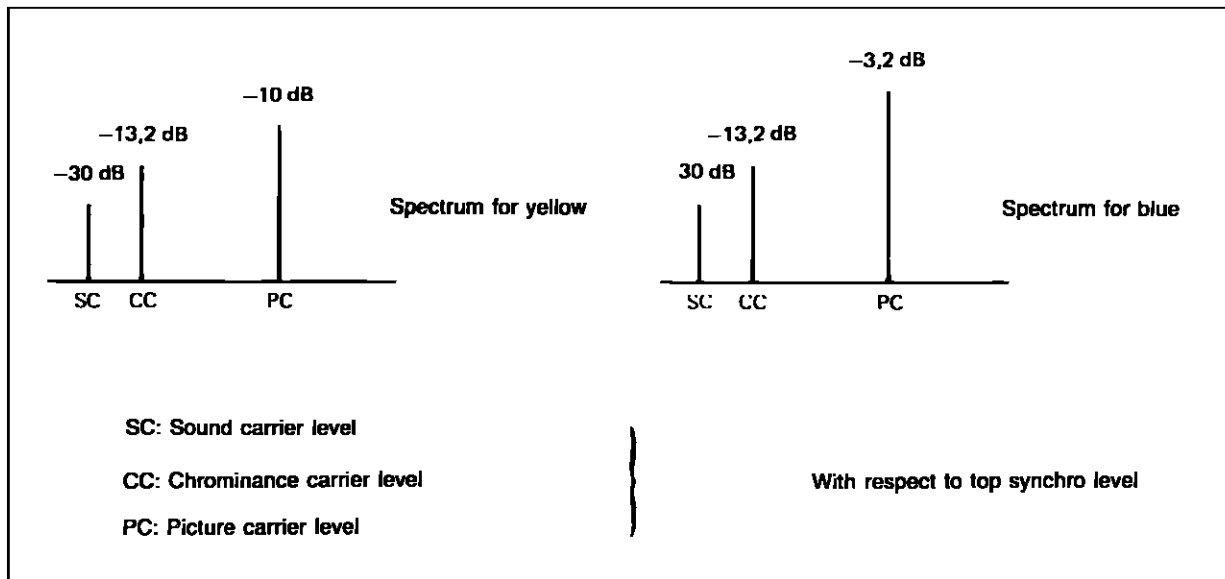
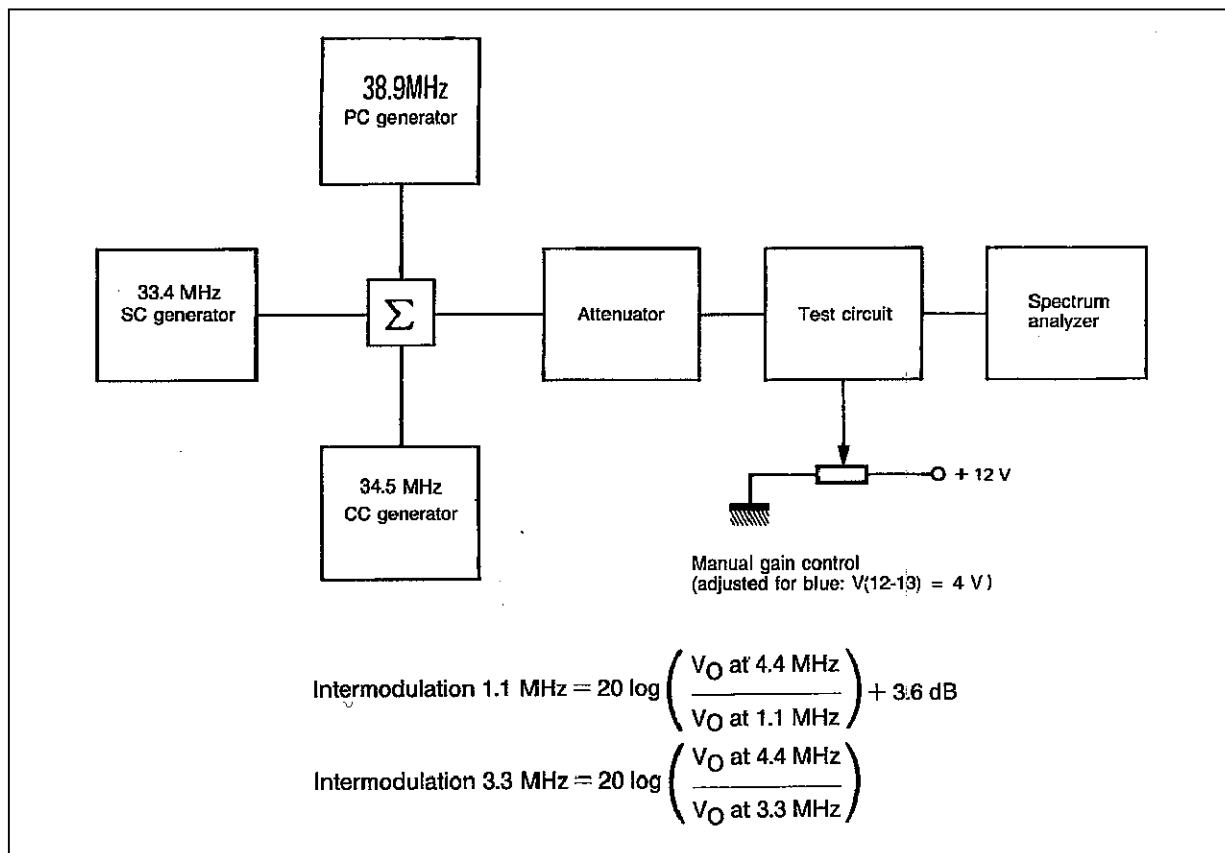

Figure 2 : Input Conditions for Intermodulation Measurements



2540-04.EPS

Figure 3 : Test Set-up for Intermodulation



2540-05.TIF

Figure 4 : AFC Voltage versus Frequency V_{5-13}

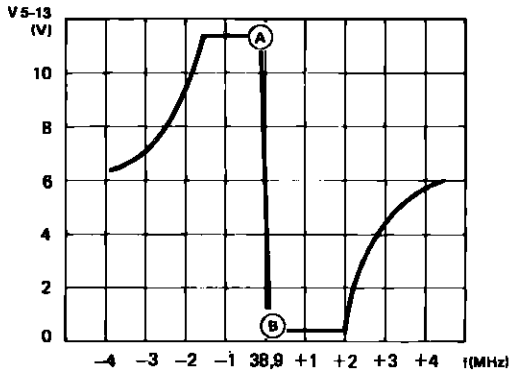

Fig. 4 — AFC VOLTAGE VERSUS FREQUENCY V 5-13

2540-06.EPS

Figure 5 : AFC Voltage versus Frequency V_{5-13}

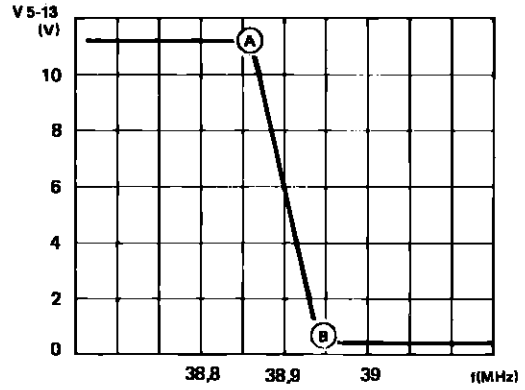

Fig. 5 — AFC VOLTAGE VERSUS FREQUENCY V 5-13

2540-07.EPS

Figure 6 : Signal/Noise Ratio versus Input Voltage V_{1-16}

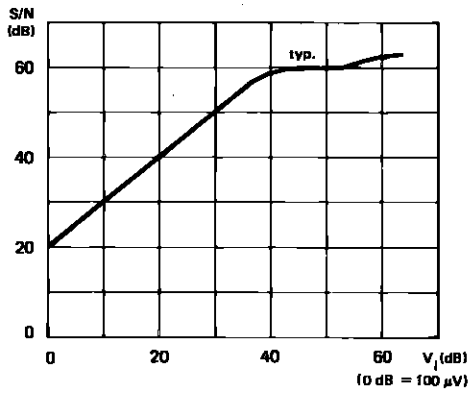
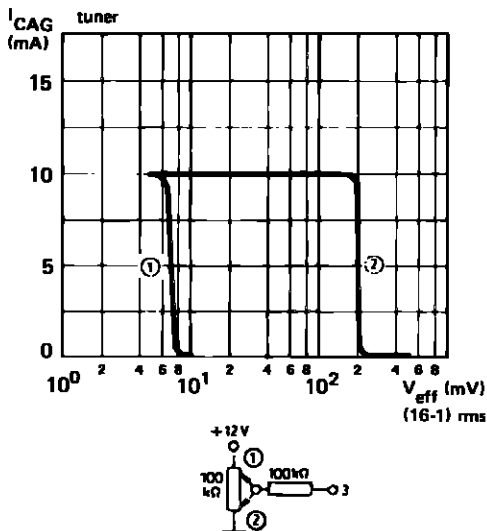

Fig. 6 — SIGNAL/NOISE RATIO VERSUS INPUT VOLTAGE V 1-16

2540-08.EPS

Figure 7 : AGC Tuner Current Curve
TDA2540



2540-09.EPS

TDA2541

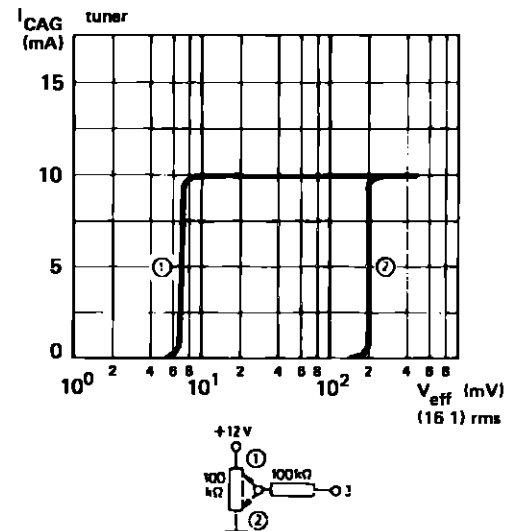

2540-10.EPS

TDA2540 - TDA2541

Figure 7 : AGC Tuner Current Curve (continued)

TDA2540 - TDA2541

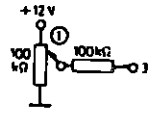
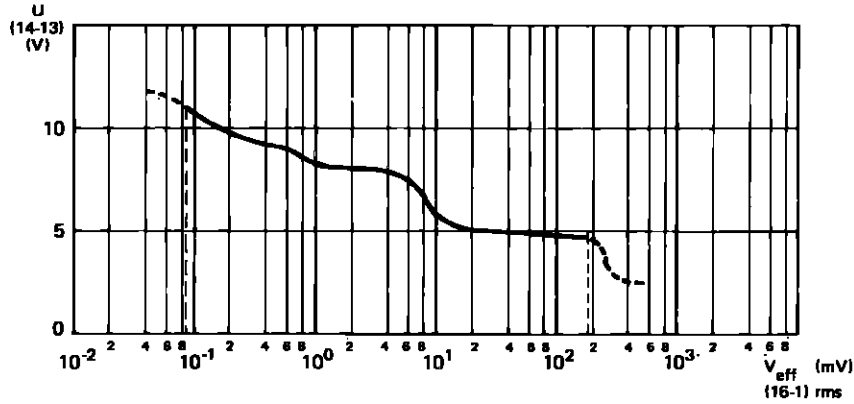

APPLICATION CIRCUIT

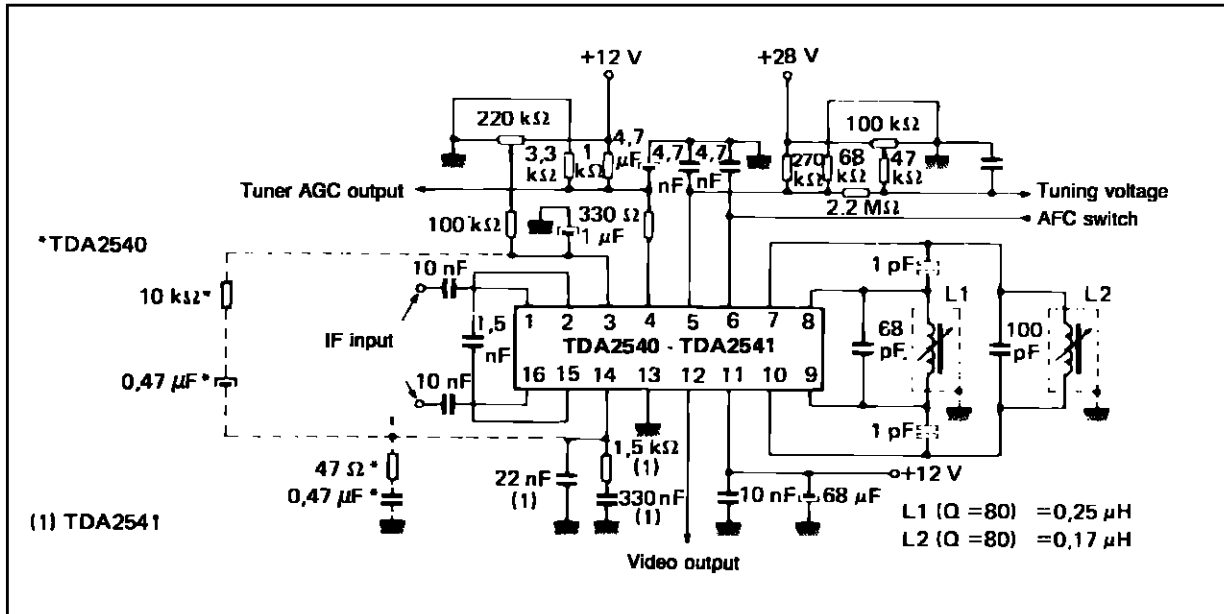

2540-11.EPS

2540-12.EPS

PACKAGE MECHANICAL DATA
16 PINS – PLASTIC DIP

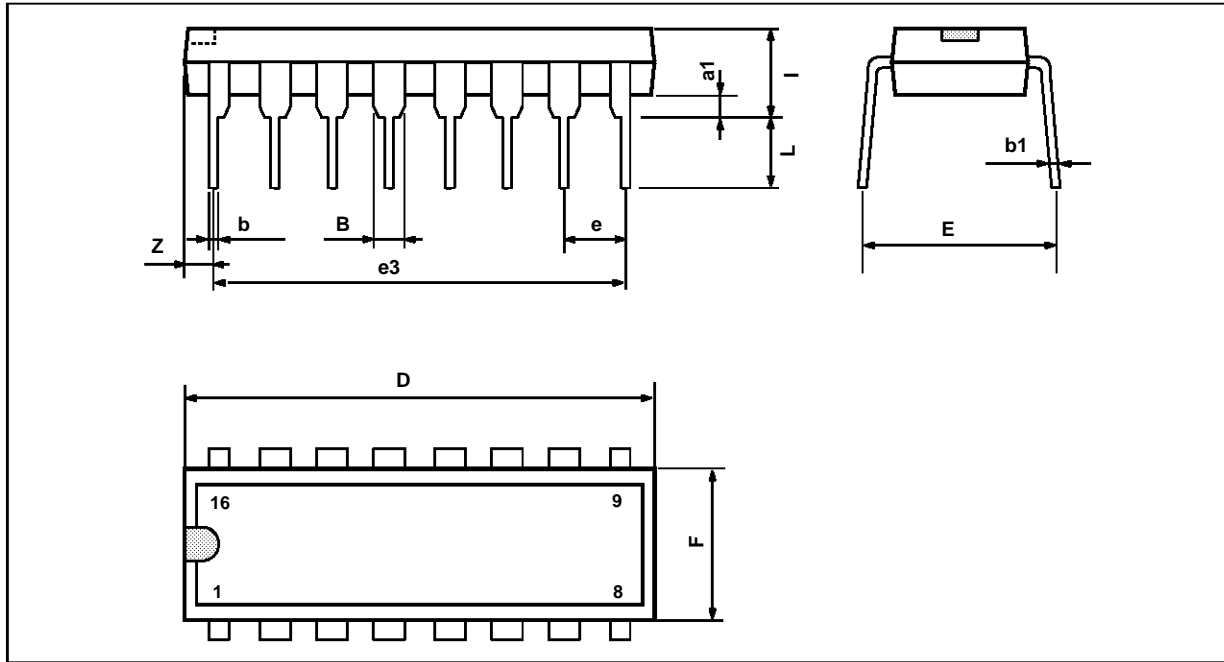

PM-DIP16.EPS

| Dimensions | Millimeters | | | Inches | | |
|------------|-------------|-------|------|--------|-------|-------|
| | Min. | Typ. | Max. | Min. | Typ. | Max. |
| a1 | 0.51 | | | 0.020 | | |
| B | 0.77 | | 1.65 | 0.030 | | 0.065 |
| b | | 0.5 | | | 0.020 | |
| b1 | | 0.25 | | | 0.010 | |
| D | | | 20 | | | 0.787 |
| E | | 8.5 | | | 0.335 | |
| e | | 2.54 | | | 0.100 | |
| e3 | | 17.78 | | | 0.700 | |
| F | | | 7.1 | | | 0.280 |
| i | | | 5.1 | | | 0.201 |
| L | | 3.3 | | | 0.130 | |
| Z | | | 1.27 | | | 0.050 |

DIP16.TBL

Information furnished is believed to be accurate and reliable. However, SGS-THOMSON Microelectronics assumes no responsibility for the consequences of use of such information nor for any infringement of patents or other rights of third parties which may result from its use. No licence is granted by implication or otherwise under any patent or patent rights of SGS-THOMSON Microelectronics. Specifications mentioned in this publication are subject to change without notice. This publication supersedes and replaces all information previously supplied. SGS-THOMSON Microelectronics products are not authorized for use as critical components in life support devices or systems without express written approval of SGS-THOMSON Microelectronics.

© 1994 SGS-THOMSON Microelectronics - All Rights Reserved

Purchase of I²C Components of SGS-THOMSON Microelectronics, conveys a license under the Philips I²C Patent. Rights to use these components in a I²C system, is granted provided that the system conforms to the I²C Standard Specifications as defined by Philips.

SGS-THOMSON Microelectronics GROUP OF COMPANIES

Australia - Brazil - China - France - Germany - Hong Kong - Italy - Japan - Korea - Malaysia - Malta - Morocco
The Netherlands - Singapore - Spain - Sweden - Switzerland - Taiwan - Thailand - United Kingdom - U.S.A.