

SANYO	No. 1596C	2SC3461
NPN Triple Diffused Planar Type Silicon Transistor FOR SWITCHING REGULATORS		

Features

- . High breakdown voltage and high reliability.
- . Fast switching speed (t_f : 0.1 μ s typ.)
- . Wide ASO.
- . Adoption of MBIT process.

Absolute Maximum Ratings at Ta=25°C

Collector-to-Base Voltage	V_{CB0}	1100	V	unit
Collector-to-Emitter Voltage	V_{CEO}	800	V	
Emitter-to-Base Voltage	V_{EBO}	7	V	
Collector Current	I_C	8	A	
Peak Collector Current	i_{cp}	25	A	$PW \leq 300\mu s, \text{Duty Cycle} \leq 10\%$
Base Current	I_B	4	A	
Collector Dissipation	P_C	140	W	$T_C = 25^\circ C$
Junction Temperature	T_j	150	°C	
Storage Temperature	T_{stg}	-55 to +150	°C	

Electrical Characteristics at Ta=25°C

		min	typ	max	unit
Collector Cutoff Current	I_{CB0}			10	μA
Emitter Cutoff Current	I_{EBO}			10	μA
DC Current Gain	$h_{FE}(1)$	10*		40*	
	$h_{FE}(2)$	8			
Gain-Bandwidth Product	f_T		15		MHz
Output Capacitance	c_{ob}		155		pF
C-E Saturation Voltage	$V_{CE(sat)}$			2.0	V
B-E Saturation Voltage	$V_{BE(sat)}$			1.5	V
C-B Breakdown Voltage	$V_{(BR)CBO}$	1100			V
C-E Breakdown Voltage	$V_{(BR)CEO}$	800			V
E-B Breakdown Voltage	$V_{(BR)EBO}$	7			V
C-E Sustain Voltage	$V_{CEX(sus)}$	800			V
Turn-On Time	t_{on}		0.5		μs
Storage Time	t_{stg}		3.0		μs
Fall Time	t_f		0.3		μs

$V_{CB} = 800V, I_E = 0$
 $V_{EB} = 5V, I_C = 0$
 $V_{CE} = 5V, I_C = 0.6A$
 $V_{CE} = 5V, I_C = 3A$
 $V_{CE} = 10V, I_C = 0.6A$
 $V_{CB} = 10V, f = 1MHz$
 $I_C = 4A, I_B = 0.8A$
 $I_C = 4A, I_B = 0.8A$
 $I_C = 1mA, I_E = 0$
 $I_C = 5mA, R_{BE} = \infty$
 $I_E = 1mA, I_C = 0$
 $I_C = 4A$
 $2I_{B1} = -I_{B2} = 0.8A,$
 $L = 1mH, \text{Clamped}$
 $V_{CC} = 400V,$
 $5I_{B2} = -2.5I_{B2} = I_C = 6A,$
 $R_L = 66.7\text{ohms}$

*: The 2SC3461 is classified by 0.6A h_{FE} as follows:

10	K	20	15	L	30	20	M	40
----	---	----	----	---	----	----	---	----

Package Dimensions 2022
(unit: mm)

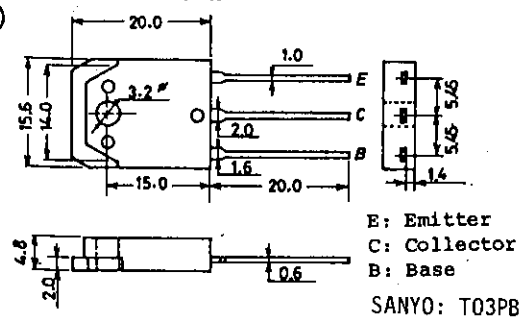

Switching Time Test Circuit

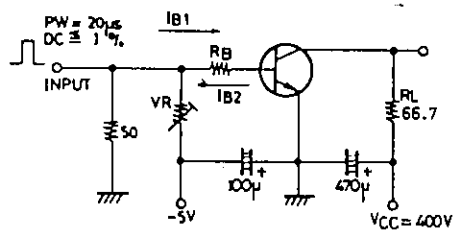

Unit (Resistance : Ω, Capacitance : F)

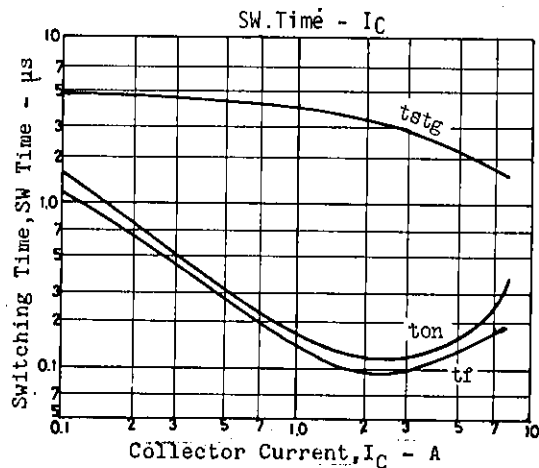
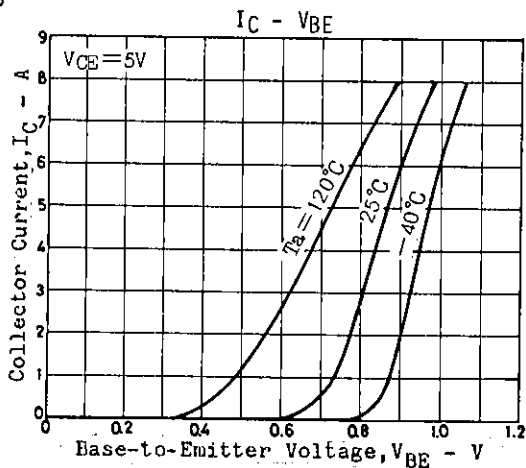
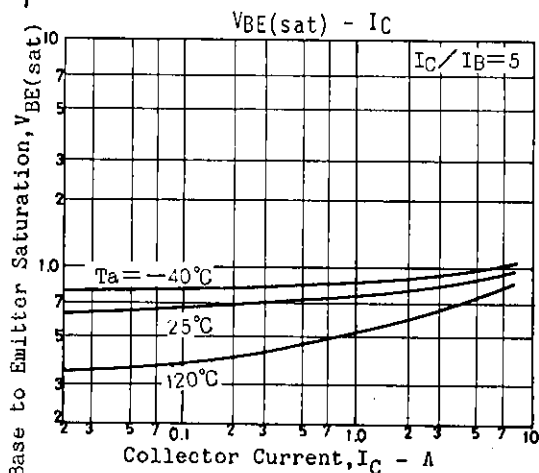
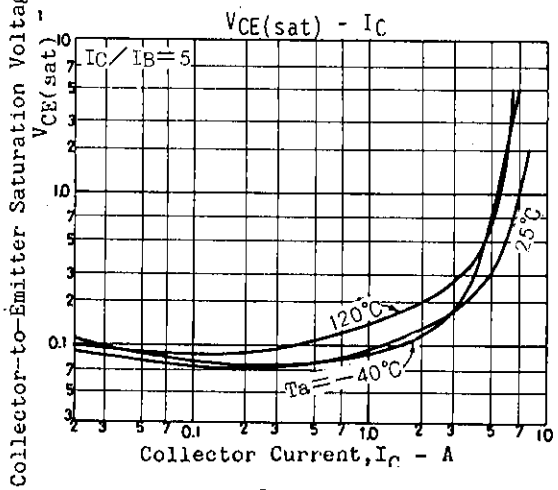
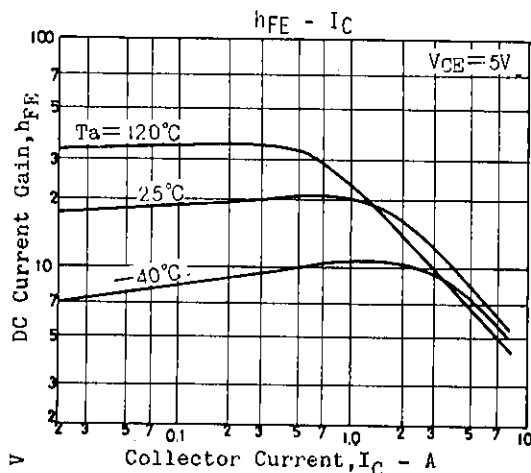
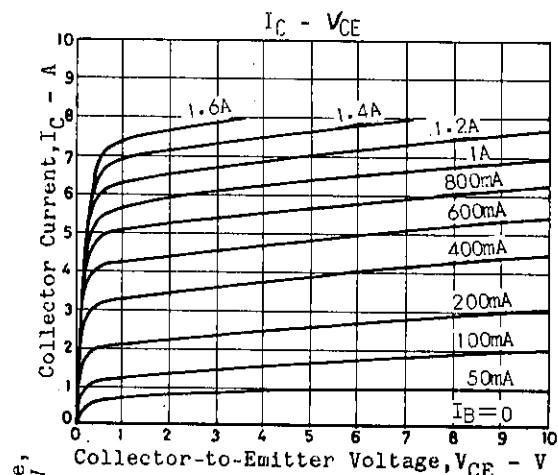

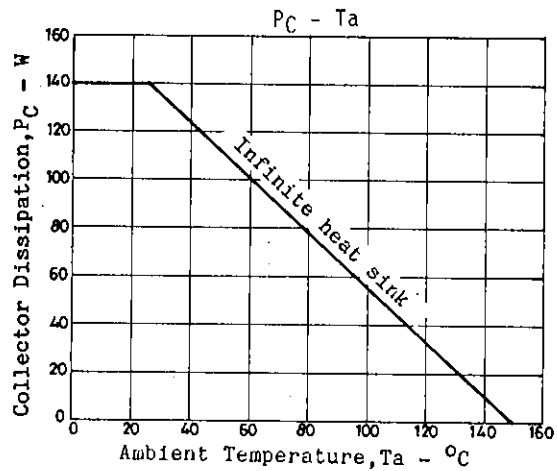
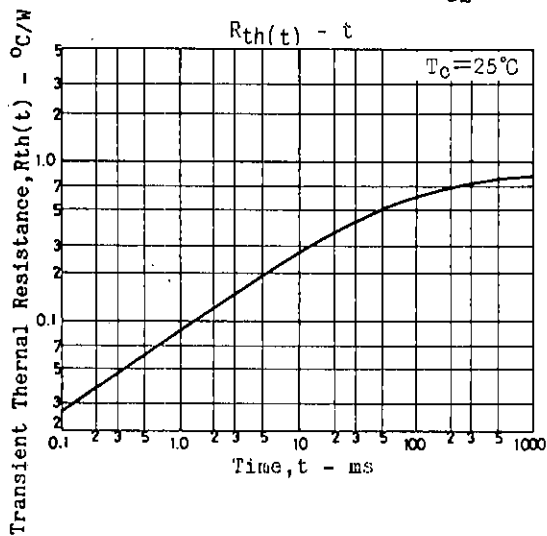
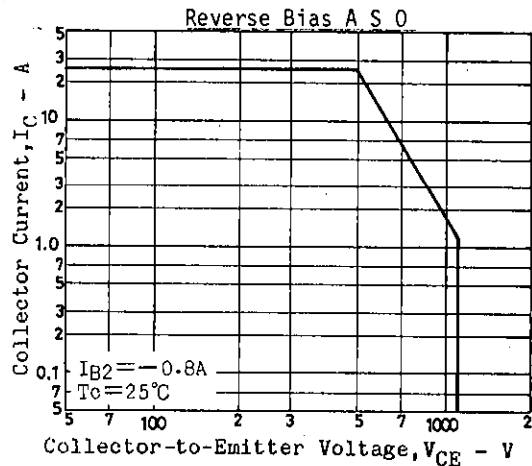
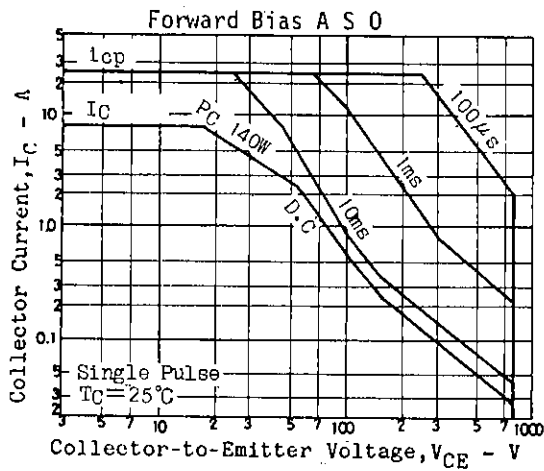

■ No products described or contained herein are intended for use in surgical implants, life-support systems, aerospace equipment, nuclear power control systems, vehicles, disaster/crime-prevention equipment and the like, the failure of which may directly or indirectly cause injury, death or property loss.

■ Anyone purchasing any products described or contained herein for an above-mentioned use shall:

- ① Accept full responsibility and indemnify and defend SANYO ELECTRIC CO., LTD., its affiliates, subsidiaries and distributors and all their officers and employees, jointly and severally, against any and all claims and litigation and all damages, cost and expenses associated with such use:
- ② Not impose any responsibility for any fault or negligence which may be cited in any such claim or litigation on SANYO ELECTRIC CO., LTD., its affiliates, subsidiaries and distributors or any of their officers and employees jointly or severally.

■ Information (including circuit diagrams and circuit parameters) herein is for example only; it is not guaranteed for volume production. SANYO believes information herein is accurate and reliable, but no guarantees are made or implied regarding its use or any infringements of intellectual property rights or other rights of third parties.