

## SILICON NPN SWITCHING TRANSISTOR

- VERY LOW SATURATION VOLTAGE
- FAST TURN-OFF AND TURN-ON

**DESCRIPTION**

High speed transistor suited for low voltage applications.

High frequency and efficiency converters switching regulators motor control.

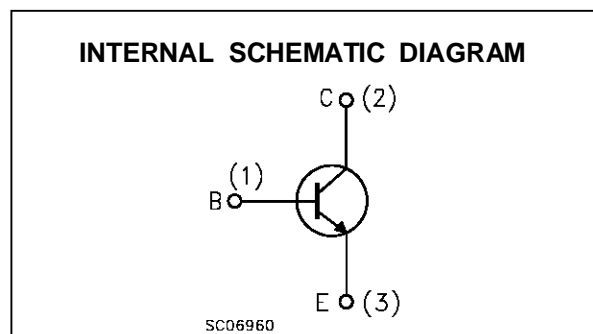
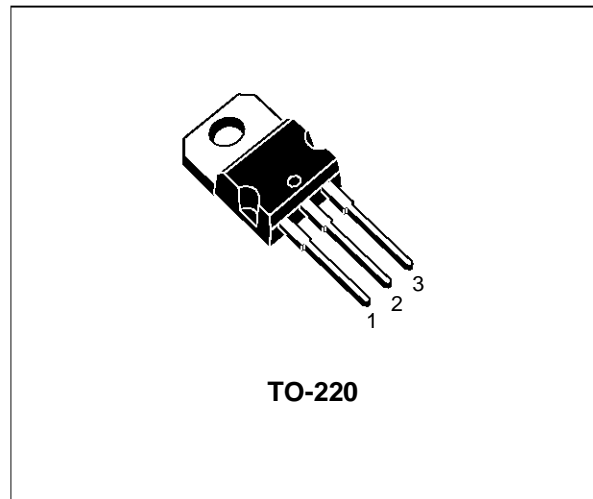
**ABSOLUTE MAXIMUM RATINGS**

Symbol	Parameter	Value	Unit
$V_{CBO}$	Collector-base Voltage ( $I_E = 0$ )	400	V
$V_{CEO}$	Collector-Emitter Voltage ( $I_B = 0$ )	200	V
$V_{EBO}$	Emitter-Base Voltage ( $I_C = 0$ )	7	V
$I_C$	Collector Current	10	A
$I_{CM}$	Collector Peak Current	15	A
$I_B$	Base Current	2	A
$I_{BM}$	Base Peak Current	4	A
$P_{tot}$	Total Dissipation at $T_c < 25\text{ }^\circ\text{C}$	85	W
$P_{tot}$	Total Dissipation at $T_c < 60\text{ }^\circ\text{C}$	65	W
$T_{stg}$	Storage Temperature	-65 to +175	$^\circ\text{C}$
$T_j$	Max. Operating Junction Temperature	175	$^\circ\text{C}$

## BUV28

### THERMAL DATA

$R_{thj-case}$	Thermal Resistance Junction-case	Max	1.76	$^{\circ}C/W$
----------------	----------------------------------	-----	------	---------------

### ELECTRICAL CHARACTERISTICS ( $T_{case} = 25^{\circ}C$ unless otherwise specified)

Symbol	Parameter	Test Conditions	Min.	Typ.	Max.	Unit
$I_{CER}$	Collector Cut-off Current ( $R_{BE} = 50\Omega$ )	$V_{CE} = 400V$ $T_c = 125^{\circ}C$			3	mA
$I_{CEX}$	Collector Cut-off Current	$V_{CE} = 400V$ $V_{BE} = -1.5V$ $T_c = 125^{\circ}C$			1	mA
$I_{EBO}$	Emitter Cut-off Current ( $I_C = 0$ )	$V_{EB} = 5V$			1	mA
$V_{CEO(sus)*}$	Collector-Emitter Sustaining Voltage	$I_C = 0.2A$ $L = 25mH$	200			V
$V_{EBO}$	Emitter-Base Voltage ( $I_C = 0$ )	$I_E = 50mA$	7		30	V
$V_{CE(sat)*}$	Collector-Emitter Saturation Voltage	$I_C = 3A$ $I_B = 0.3A$ $I_C = 6A$ $I_B = 0.6A$			0.7 1.5	V V
$V_{BE(sat)*}$	Base-Emitter Saturation Voltage	$I_C = 6A$ $I_B = 0.6A$			2	V
$t_{on}$	<b>RESISTIVE LOAD</b> Storage Time	$V_{CC} = 150V$ $I_C = 6A$		0.3	1	$\mu s$
$t_s$	Fall Time	$V_{BE} = -6V$ $I_{B1} = 0.6A$		0.5	1.5	$\mu s$
$t_r$	Turn-on Time	$R_{BB} = 5\Omega$		0.1	0.25	$\mu s$
$t_s$	<b>INDUCTIVE LOAD</b> Storage time	$V_{CC} = 150V$ $I_C = 6A$		1		$\mu s$
$t_r$	Fall Time	$I_{B1} = 0.6A$ $V_{BE} = -5V$ $L_B = 1\mu H$		0.04		$\mu s$
$t_s$	Storage Time	$V_{CC} = 150V$ $I_C = 6A$			3	$\mu s$
$t_r$	Fall Time	$I_{B1} = 0.6A$ $V_{BE} = -5V$ $L_B = 1\mu H$ $T_j = 125^{\circ}C$			0.2	$\mu s$

\* Pulsed: Pulse duration = 300 $\mu s$ , duty cycle = 2%

**TO-220 MECHANICAL DATA**

DIM.	mm			inch		
	MIN.	TYP.	MAX.	MIN.	TYP.	MAX.
A	4.40		4.60	0.173		0.181
C	1.23		1.32	0.048		0.051
D	2.40		2.72	0.094		0.107
D1		1.27			0.050	
E	0.49		0.70	0.019		0.027
F	0.61		0.88	0.024		0.034
F1	1.14		1.70	0.044		0.067
F2	1.14		1.70	0.044		0.067
G	4.95		5.15	0.194		0.203
G1	2.4		2.7	0.094		0.106
H2	10.0		10.40	0.393		0.409
L2		16.4			0.645	
L4	13.0		14.0	0.511		0.551
L5	2.65		2.95	0.104		0.116
L6	15.25		15.75	0.600		0.620
L7	6.2		6.6	0.244		0.260
L9	3.5		3.93	0.137		0.154
DIA.	3.75		3.85	0.147		0.151

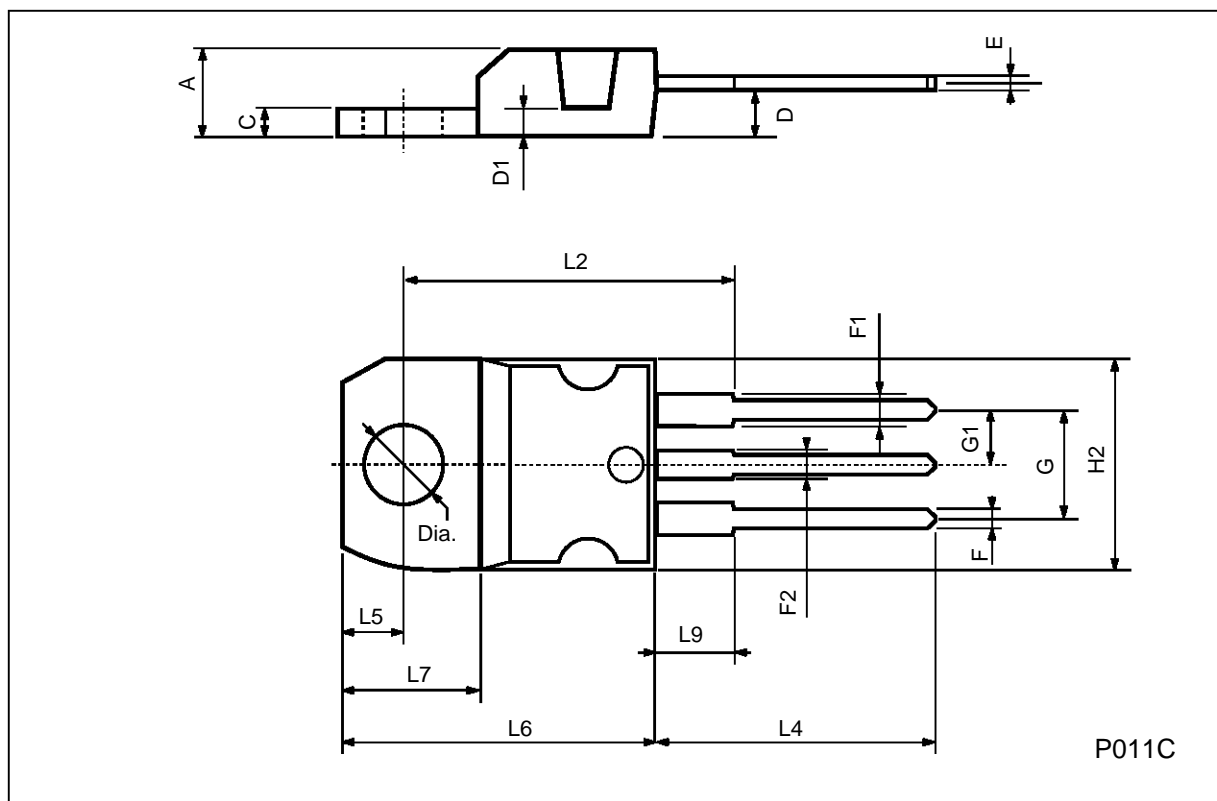

Information furnished is believed to be accurate and reliable. However, SGS-THOMSON Microelectronics assumes no responsibility for the consequences of use of such information nor for any infringement of patents or other rights of third parties which may result from its use. No license is granted by implication or otherwise under any patent or patent rights of SGS-THOMSON Microelectronics. Specifications mentioned in this publication are subject to change without notice. This publication supersedes and replaces all information previously supplied. SGS-THOMSON Microelectronics products are not authorized for use as critical components in life support devices or systems without express written approval of SGS-THOMSON Microelectronics.

© 1995 SGS-THOMSON Microelectronics - All Rights Reserved

SGS-THOMSON Microelectronics GROUP OF COMPANIES

Australia - Brazil - France - Germany - Hong Kong - Italy - Japan - Korea - Malaysia - Malta - Morocco - The Netherlands -  
Singapore - Spain - Sweden - Switzerland - Taiwan - Thailand - United Kingdom - U.S.A

...