



PROFESSIONAL

## Technical Note Volume 3, Number 2A

### The New JBL LSR6300 Series Studio Monitors

#### 1. Introduction:

In earlier days, studio monitor loudspeakers were designed for flat on-axis response, with secondary concern for off-axis response uniformity. With the introduction of JBL's Bi-Radial® monitors in the early 1980s, JBL began to address the balance between on- and off-axis response and the importance of this balance in ensuring that the combination of direct and reflected sound reaching the listener was uniform. In the late 1990s JBL introduced the first LSR (Linear Spatial Reference) products, and now the LSR6300 Series has been improved to achieve an even higher degree of performance.

The new models use improved structural materials for further damping and rigidity of the enclosures. The LSR6328P now has integral handles, and all LSR6300 products have built-in mounting points for ease and flexibility of installation. The products in the group are all THX pm3® approved.

The HF transducer in the full-range systems was previously unshielded, making operation of the systems in proximity to a CRT type video monitor difficult. The new driver is shielded.

Most significant is the addition of JBL RMC™ Room Mode Correction to two of the powered LSR6300 models. RMC provides a means for precise equalization of the dominant room mode, thus providing more accurate LF response of the LSR6328P and LSR6312SP in typical production environments. It is explained in fuller detail in the User Guide that accompanies the RMC system calibration kit.

#### 2. The Linear Spatial Reference (LSR) Concept:

Stated simply, LSR provides:

1. A forward listening angle over which the system's *direct sound field* response does not deviate from a given standard. This ensures that all listeners located within a solid angle of  $\pm 30$  degrees horizontally and  $\pm 15$  degrees vertically will hear substantially the same balance.

2. An early *reflected sound field* which is substantially smooth, uniform, and free of irregularities over the frequency range. This ensures that the pattern of room reflections in the room will complement the direct sound, not conflict with it.

3. A substantially smooth radiated power response. This complements items 1 and 2. If the room itself is acoustically uniform in its absorption treatment, then the reflected sound field, in actuality the room response, will likewise be uniform.

This response is achieved through careful selection of crossover frequencies and slopes, placement of drivers on the baffle, and the use of waveguides, integral to the baffle, to shape the coverage angles of MF and HF drivers.

The measurements shown in Figure 1A and B illustrate the degree to which the LSR6332 and LSR6328P attain their design goals. The labeled curves are described below:

1. On-axis response.
2. Averaged response over a listening window which is  $\pm 30$  degrees horizontally and  $\pm 15$  degrees vertically.
3. Averaged simulated early reflections arriving 5 to 10 milliseconds after the direct sound and lasting for approximately 10 to 20 milliseconds.
4. Total radiated sound power.
5. Directivity index of sound power.

6. Directivity index of early reflections.

Notice in particular how closely the on-axis response and the averaged listening-window response track each other.

**A. Curves for LSR6332**

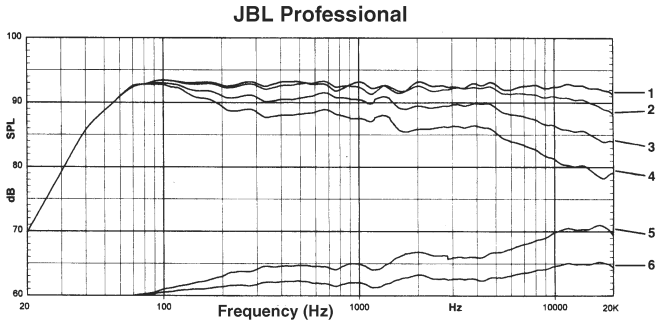

**B. Curves for LSR6328P**

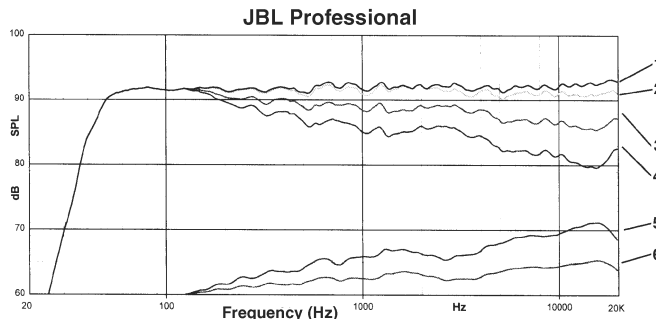

Figure 1. LSR curve families. LSR6332 (A); LSR6328P (B).

Figure 2 shows the LSR curve family for an earlier three-way monitor that was designed primarily for flat on-axis response. You can clearly see the irregularities in the early reflection pattern and the total radiated power, which translate directly into irregular reflected signal at the listener.

The model LSR6332 is intended for both vertical and horizontal mounting at the user's discretion. In order to preserve the response shown in Figure 1A, the baffle

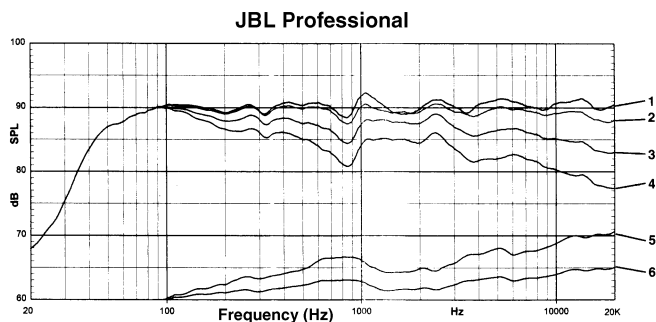

Figure 2. LSR curves for an earlier three-way model.

containing the MF and HF transducers can be rotated as shown in Figure 3.

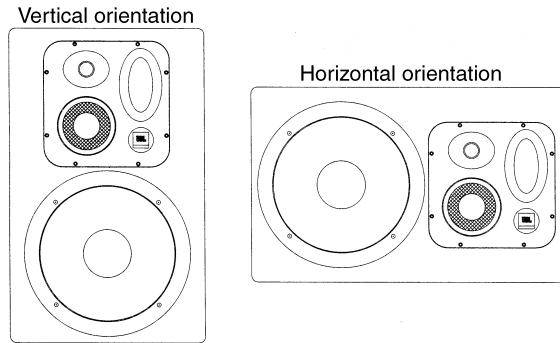

Figure 3. LSR6332 MF and HF baffle rotation for horizontal or vertical mounting.

**3. Transducer Development:**

The LF drivers used in the LSR6332, LSR6328P, and LSR6312SP systems make use of Differential Drive® topology. In addition, models LSR6332 and LSR6312SP use neodymium magnets, a technique that results in lighter weight, inherent magnetic shielding, and lower distortion. Figure 4 shows a section view of a Differential Drive transducer with the two drive coils labeled.

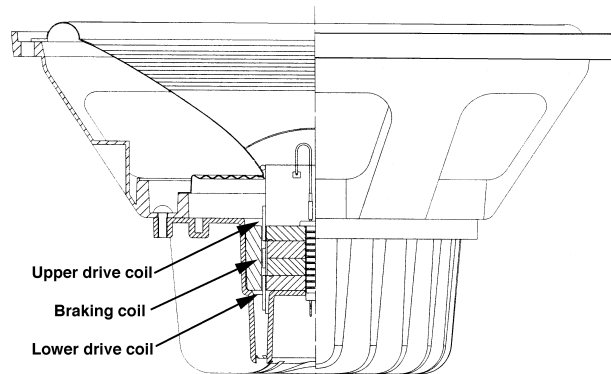

Figure 4. Cutaway view, LF driver for LSR6332 system.

Located between the drive coils is a *braking coil*; this is a short-circuited coil that responds only when cone excursions are at maximum. For normal modulation it has no effect; but when high excursions are encountered the braking coil enters the magnetic field and acts to restrain cone motion. This action linearizes cone displacement, resulting in lower distortion at high operating levels, as indicated in Figure 5.

The midrange (MF) driver for the LSR6332 system is shown in Figure 6. The driver has a neodymium motor and is thus well shielded magnetically. The voice coil has a diameter of 50 mm (2 in) for high power handling capability. The cone is of woven Kevlar®, and the outer

Voltage required to attain a peak displacement in a dual 10-inch LF driver, with and without braking coil. Drive signal at 30 Hz. At 0.6 inches, braking coil is fully immersed in gap.

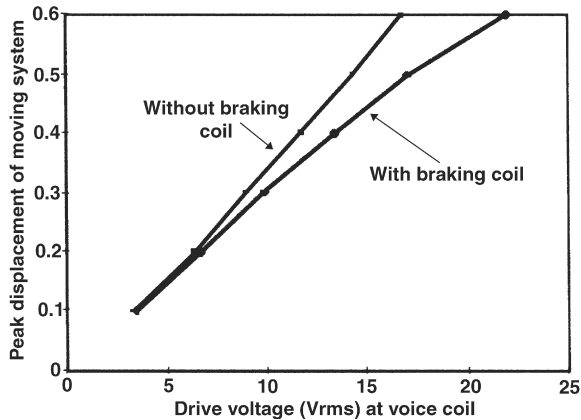

Figure 5. Action of braking coil in Differential Drive® systems.

half-roll surround is of butyl rubber. The transducer has sufficient excursion capability and linearity to enable it to be crossed over at 250 Hz, operating comfortably at rated input power. It is free of the midrange distortion that afflicts many similar drivers operating in the 250 Hz range at high levels.

The model 053TiS high frequency (HF) driver, redesigned with magnetic shielding, is shown in Figure 7. It has a 25 mm (1 in) smooth titanium dome which has been damped by a thin coating of Aquaplas® as well as with a unique low recovery foam pad in the rear cavity adjacent to the diaphragm. Its frequency response extends smoothly beyond 20 kHz. When

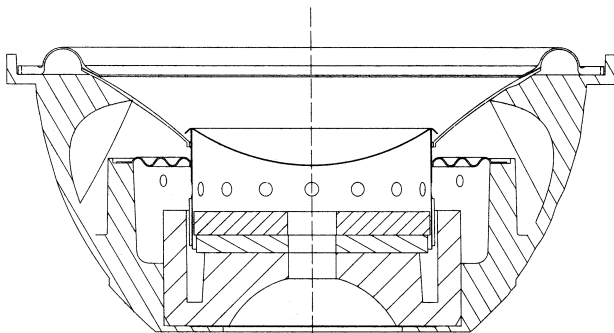

Figure 6. Cross-section view of MF driver in LSR6332 system.

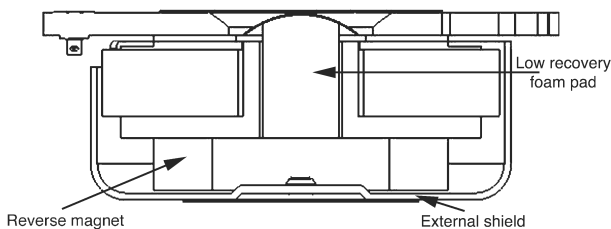

Figure 7. Cross-section view of HF driver in LSR6332 and LSR6328P systems.

mounted in both the LSR6332 and LSR6328P systems, the HF driver is loaded by an elliptical oblate spheroid waveguide that controls the driver's dispersion in the crossover range.

With the shielding of the HF driver (plus the inherent shielding in the neodymium structures), the new LSR6300 systems can be used in close proximity to cathode ray type video monitors in all applications.

#### 4. Detailed Performance of the LSR6332 System:

##### Overview of System:

- Three-way passive with 300 mm (12 in) LF driver
- Sensitivity: 90 dB SPL, 1 W input at 1 m (93 dB SPL, 2.83 Vrms input at 1 m)
- Impedance: 4 ohms nominal
- Nominal frequency response: 60 Hz – 22 kHz, +1 dB, –1.5 dB
- Long term maximum power (IEC265-5): 200 W continuous (113 dB SPL)
- System dimensions (W × H × L): 635 × 394 × 292 mm (25 × 15.5 × 11.5 in)
- System weight: 20.4 kg (45 lb)
- Integral M6 mounting points

In addition to the superlative directional response shown in Section 2 of this Technical Note, the LSR6332 excels as well in areas of distortion and in time domain integrity. We now discuss these:

##### Response Uniformity:

Figure 8 shows the contribution of each transducer in the system. Noteworthy here are the steep 24 dB/octave transitions between sections and the in-phase –6 dB summation at each transition that are characteristic of Linkwitz-Riley filter designs. The high slopes between adjacent elements are crucial in assuring smooth response throughout the target listening windows. All network components in the primary signal paths are of the highest quality, including low loss capacitors and high saturation current, low distortion inductors.

The system's response has been so precisely adjusted that JBL felt the only useful option for the user would be a relatively small HF adjustment, as shown in Figure 9. Here, you can see the effect of the –1 dB jumper setting on the terminal block on the rear of the enclosure. While this may look very small, bear in mind that a one-dB adjustment over a range of about three octaves is significant in terms of acoustical power reduction. The user will normally opt for flat response, the –1 dB option being called for when the systems are used in rooms that have minimal absorption at higher frequencies.

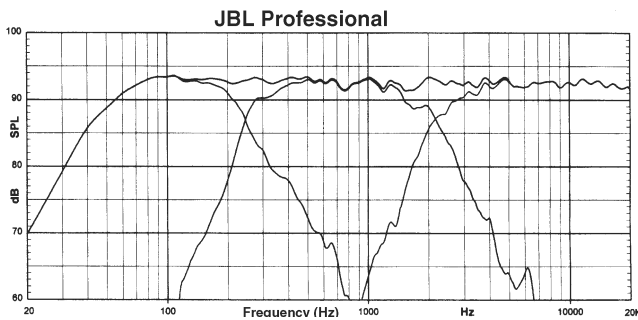

Figure 8. LF, MF, and HF contributions in LSR6332 system.

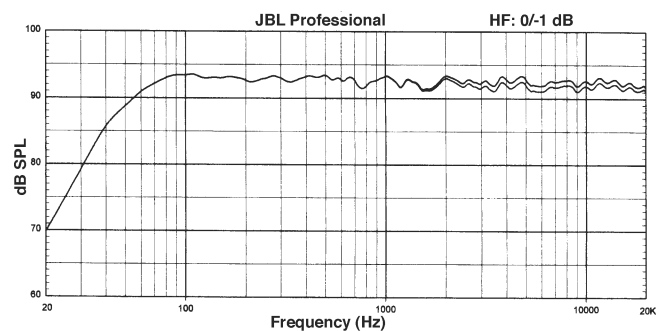

Figure 9. HF 0 dB/-1 dB option in LSR6332.

### Wide-Band Distortion:

Plots of second and third harmonic distortion components at nominal listening levels of 96 dB and 102 dB SPL, measured at a distance of 1 meter, are shown in Figure 10. The distortion plots in these graphs have been raised 20 dB for ease in reading. At A, the distortion components above 100 Hz are  $-40$  dB relative to the fundamental, while at B the same components are about  $-35$  dB relative to the fundamental. This is remarkable performance for any loudspeaker when you consider that peak program levels in a surround sound environment with the loudspeakers at an average distance of 2 meters from the listeners would be in the range of 100 dB SPL. This would correspond to a per-loudspeaker reference level of about 100 dB SPL at 1 meter.

### Port Turbulence:

At low frequencies in the region of port tuning, many LF systems exhibit what is called *port compression*, a tendency for turbulence to develop in the port and cause both noise and distortion. Contouring of the port terminations, both inside and outside the enclosure, can reduce this tendency considerably. JBL uses a proprietary Linear Dynamics Aperture port, whose cross-section contour is shown in Figure 11. The effect of this port, as compared to a straight port, is shown in Figure 12. The difference between the LSR6332 port and the normal straight port design can be clearly seen, reaching a difference of 4.4 dB at a power input of 400 watts. Note that for the LSR6332 system there

### A Distortion: 96 dB at 1 m

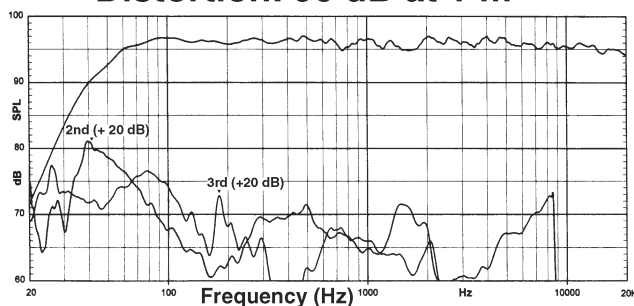

### B Distortion: 102 dB at 1 m

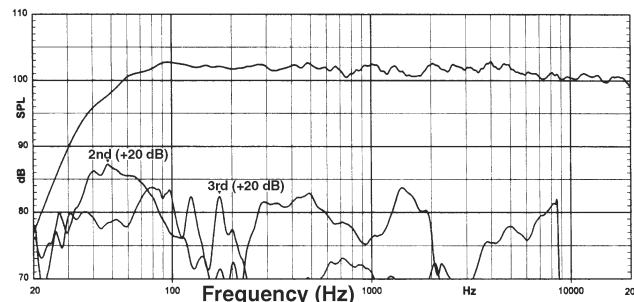

Figure 10. Second and third harmonic distortion in LSR6332, 96 dB and 102 dB SPL at 1 meter.

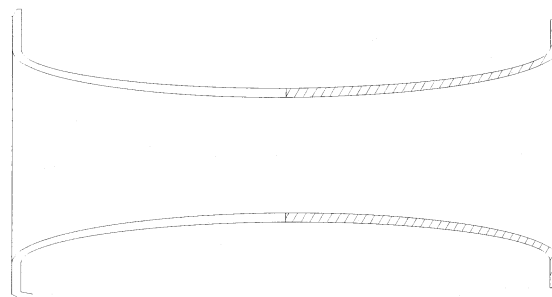

Figure 11. Linear Dynamics Aperture port contour as used in the LSR6300 Series.

is about 0.5 dB compression at 10 watts input, gradually increasing to 2 dB for 100 watts input. For the straight port the compression at 10 watts is 1.5 dB, increasing to 4.5 dB at 100 watts.

### Power Compression:

Power compression results from heating of the voice coil, which causes an increase in voice coil resistance. The result of this is a loss of overall electromechanical coupling in the driver and a loss of output. Power compression is normally shown by scaling and superimposing curves run at different values of input power. If there were no power compression at all, then the response curves would lie directly one atop the other. Figure 13 shows the power compression in the LSR6332 system at power inputs of 10, 30, and 100 watts. The curves have been normalized so that the flat curve at 0 dB represents the response measured

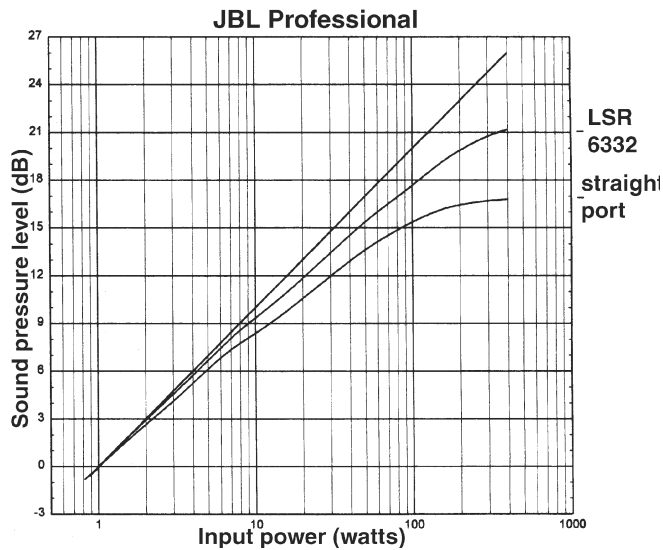

Figure 12. Effect of port contours on output of system.

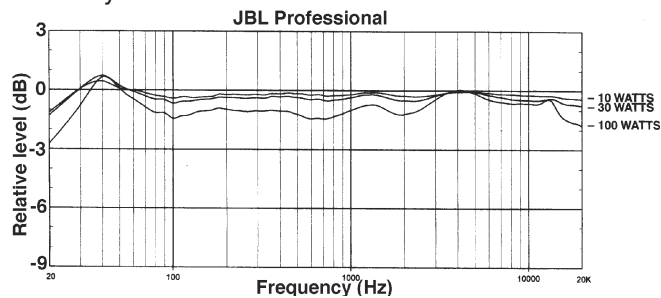

Figure 13. Power compression due to voice coil heating in LSR6332 system.

at 1 watt. At 100 watts input, the power compression is less than 1.5 dB.

### Time Domain Performance:

In today's systems engineering, all causes of excess phase shift through the system are identified and reduced to their lowest practicable values. The greatest offenders here have historically been loudspeakers. With reasonable care in baffle layout and well designed dividing network topology, deviations can be kept to a minimum. Amplitude and phase plots for the LSR6332 are shown in Figure 14.

The *group delay* through the system is given below:

$$\text{Delay (seconds)} = -d\phi/d\theta$$

where  $\phi$  is the phase shift in radians and  $\theta$  is the angular frequency in radians per second. The portion of the phase plot from about 100 Hz to 5000 Hz has a uniform slope, indicating that the time delay behavior of the system will be constant over that range. The frequency extremes deviate slightly from this constant value, but are consistent with the respective LF and HF rolloffs.

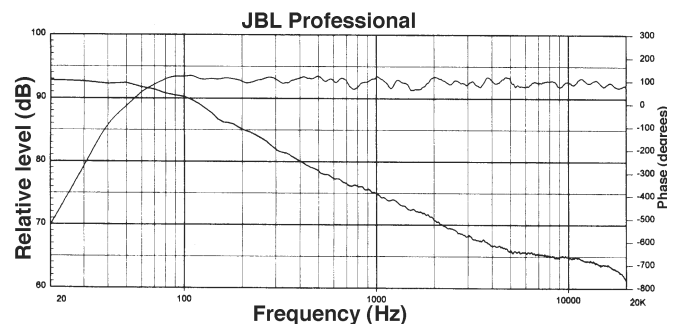

Figure 14. Phase and amplitude response of the LSR6332 system.

## 5. Detailed Performance of the LSR6328P System:

### Overview of System:

Two-way powered system with 200 mm (8 in) diameter LF driver

Maximum peak SPL (80 Hz – 20 kHz): 111 dB SPL at 1 meter

Numerous LF and HF shelving frequency controls  
Nominal frequency response: 50 Hz – 20 kHz, +1 dB, -1.5 dB

One parametric section for room mode correction (RMC)

System dimensions (W × H × L): 406 × 330 × 325 mm (16 × 13 × 12.75 in)

System weight: 17.7 kg (39 lb)

Integral M6 mounting points and handles

### Response Uniformity:

The 200 mm (8 in) LF driver maintains smooth response up to 2 kHz, which allows it to cross over smoothly with the HF driver in the range of 1.7 kHz in a Linkwitz-Riley configuration, as shown in Figure 15. The frequency division has been realized electronically.

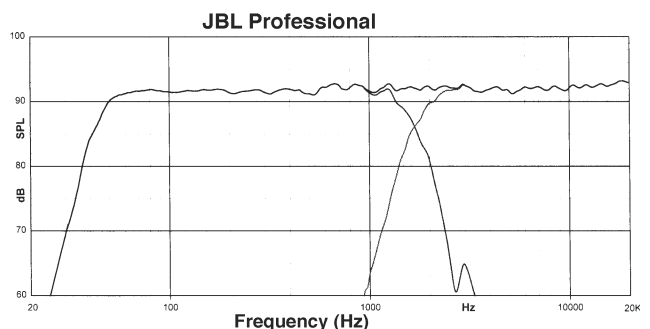

Figure 15. LF and HF contributions in response of the LSR6328P system.

### Time Domain Performance:

As a 2-way system, the time domain performance of the LSR6328P will show a slight deviation in the uniformity of the phase plot, as compared with the 3-

way system. This can be seen in Figure 16, where the phase plot has a slight curve in the range between 200 Hz and 2 kHz. Note however that the total range of phase shift, from low to high frequencies, is the same as that of the LSR6332.

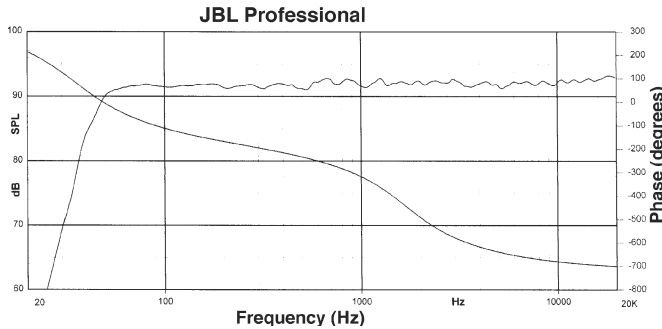

Figure 16. Phase and amplitude response of the LSR6328P system.

**Distortion:**

Distortion curves at 96 dB and 102 dB, both at one meter, are shown in Figure 17. At 96 dB, the distortion at 70 Hz and above is less than 3%, while at 102 dB it is less than 9%. Excellent performance for a 2-way system with a 200 mm (8 in) diameter LF driver.

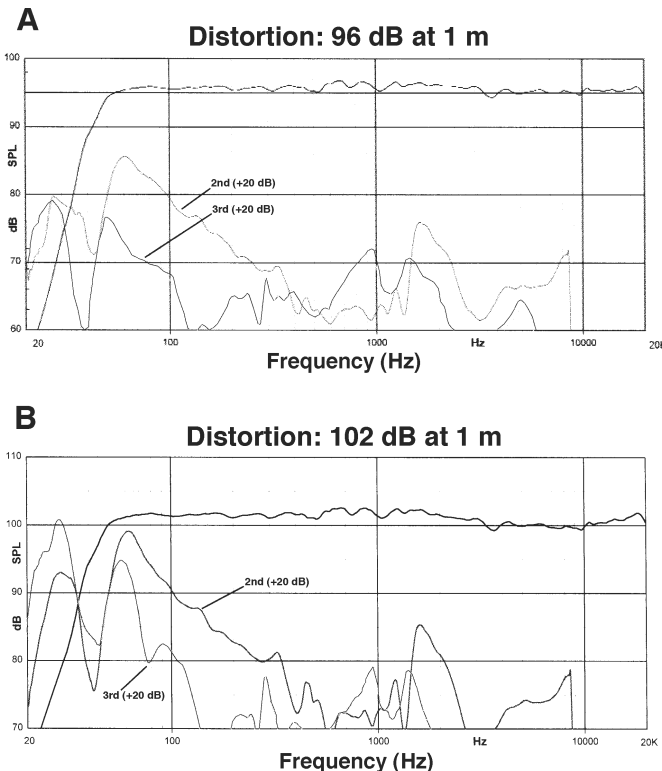

Figure 17. Second and third harmonic distortion in the LSR6328P, 96 dB and 102 dB SPL at 1 meter.

**LF and HF Contour Controls:**

The LSR6328P has a number of user response options that are accessible via DIP switches on the rear panel. Figure 18 shows the effect of an LF

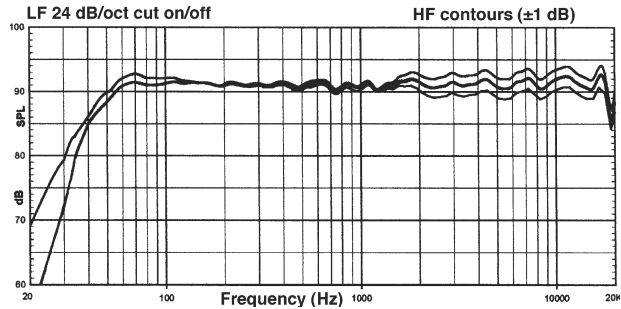

Figure 18. LF 24- or 36-dB/octave alignment choice for LSR6328P; HF ±1 dB choices.

alignment switch that converts the normal 24 dB/octave response to 36 dB/octave. 24/dB/octave is the “natural” alignment of a ported system, but it allows subsonic disturbances to pass through the system. When that position is engaged, the user can observe the excess cone movement caused by LF noises or disturbances that could be objectionable in a recording. Normally, the “VLF Protect” switch is engaged to remove these effects from the monitor system. There are three HF response positions: flat, +1, and -1, for fine-tuning the system to the working environment.

**Boundary Compensation:**

The LSR systems are designed to exhibit flat LF response when placed in a free-standing position away from a wall or corner. Using DIP switches, a broad LF cut of 1.5, 3, or 4.5 dB can be introduced into the LSR6328P system, as may be required, when the system is operated in positions close to a wall, on a work surface, or on the meter bridge of a console. When the system is positioned adjacent to a boundary it may be beneficial to introduce a 1.5 dB cut, while placement near a corner may require up to 4.5 dB of cut. Figure 19 shows the effects of these curves. For essentially the same purpose, the LSR6312SP has a boundary compensation curve that introduces a 2-dB cut at 50 Hz when that system is positioned against a wall or corner.

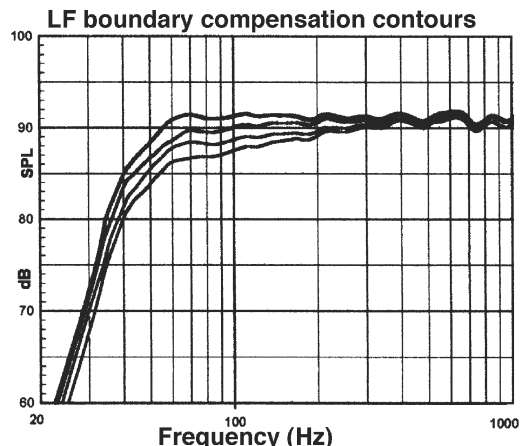

Figure 19. Boundary compensation curves for the LSR6328P.

## Typical RMC Families of Curves:

Both the LSR6328P full range system and the LSR6312SP subwoofer incorporate a feature called Room Mode Correction (RMC). RMC consists of a single section of parametric equalization that can be used to compensate for the rise in LF response caused by a dominant room mode. The correction frequencies range in tenth-octave increments from 26 Hz to 106 Hz, and up to 14 dB of cut may be introduced into the system for compensation. The width of the curves (Q factor) are likewise adjustable, from 1/2 octave to 1/20 octave. The technique of making the adjustments is covered in an analysis kit available with the systems. Examples of the curve families are shown in Figures 20 and 21.

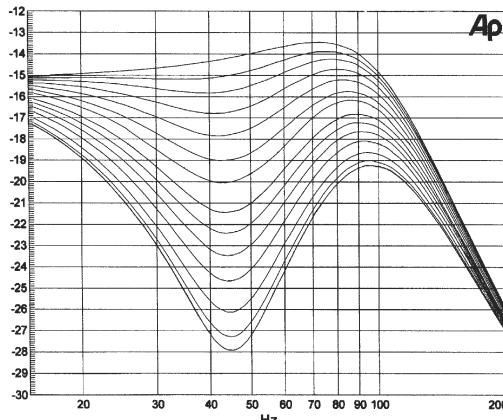

Figure 20. Family of RMC depth curves (constant Q).

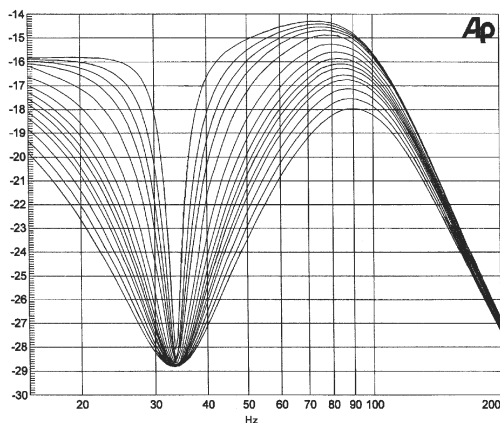

Figure 21. Family of RMC width (Q) curves at constant depth.

## 5. Detailed Performance of the LSR6325P System:

### Overview of System:

Two-way system with 133 mm (5.25 in) LF driver  
 Maximum peak level: 109 dB at 1 meter  
 LF boundary compensation and 80-Hz bypass  
 Nominal frequency response: 70 Hz – 20 kHz,  
 +1 dB, -2 dB  
 HF contours: -1, flat, +1 dB  
 Dimensions (W × H × D): 173 × 269 × 241 mm

(6.8 × 10.6 × 9.5 in)  
 Weight: 7.7 kg (17 lb)  
 Integral M6 mounting points

### On-axis and Time Domain Performance:

The on-axis and time domain performance of the LSR6325P are very similar to those of the LSR6328P, as can be seen by comparing Figures 16 and 22. The primary difference is the LF -3 dB point, which is 70 Hz for the LSR6325P and 50 Hz for the LSR6328P. This allows the two models to be mixed effectively in surround systems, where the rear channel LF program content is often lower than that of the front channels.

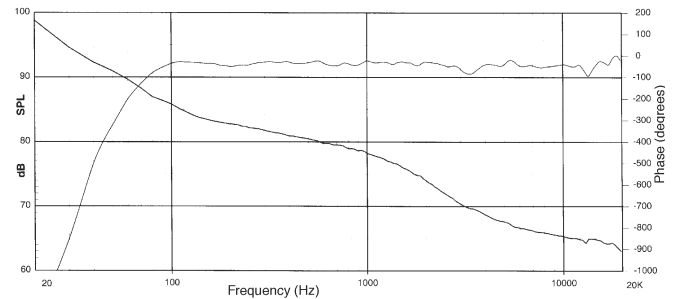

Figure 22. Amplitude and phase response for the LSR6325P system.

### Distortion:

Distortion curves for the LSR6325P are shown in Figure 23. At a fundamental level of 90 dB SPL at 60 Hz, the values of second and third harmonic components are approximately 6.5%, which is unusually low for a system as small as the LSR6325P.

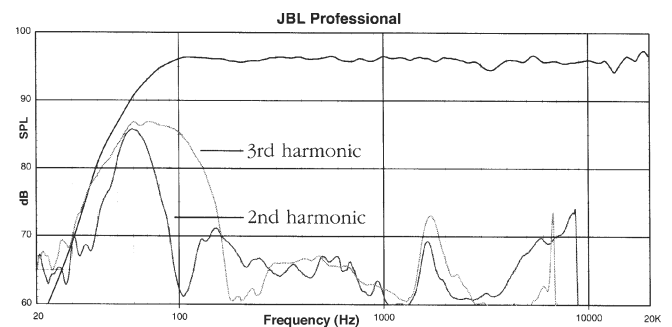

Figure 23. Harmonic distortion at 96 dB SPL at 1 meter for the LSR6325P system.

### HF and LF Contour Controls:

Figure 24 shows the response of LF and HF contours in the LSR6325P. The HF contours of -1, 0, and +1 dB further enable the system to be used in conjunction with the LSR6328P with excellent response matching, while the 80 Hz high-pass enables the system to be used effectively with the LSR6312SP. A single position of boundary compensation adjusts for system location at or near a large boundary.

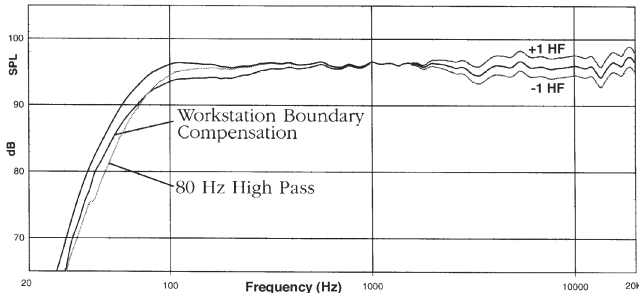

Figure 24. LF and HF adjustments for the LSR6325P system.

## 6. Detailed Performance of the LSR6312SP Subwoofer System:

### Overview of System:

Subwoofer system with single 300 mm (12 in) diameter driver

Self-contained amplifier with 260 watt (continuous) rating

Enclosure resonance frequency: 28 Hz

Maximum continuous output (35 to 80 Hz): 112 dB, 1 meter

Wide range of user options in system sensitivity, polarity, and boundary EQ

Wide range of interface/bass management options

Dimensions (W × H × L): 635 × 394 × 292 mm (25.0 × 15.5 × 11.5 in)

Weight: 22.7 kg (50 lb)

Integral M6 mounting points

### Amplitude Matching of LSR6312SP with LSR6328P:

When the LSR6312SP and LSR6328P are positioned on the same plane, the  $-6$  dB transition between them is in-phase, producing flat response over that region, as shown in Figure 25. However, in many installations the subwoofer cannot be placed in such an advantageous position, and the user often has to change polarity on the subwoofer in order to achieve the best match at the crossover frequency.

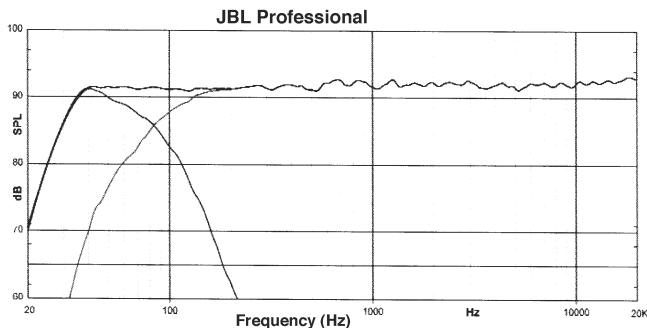

Figure 25. Amplitude matching of LSR6312SP and LSR6328P.

### Distortion:

Second and third harmonic distortion of the LSR6312SP is shown in Figure 26 for an operating level of 96 dB measured at a distance of 1 meter. The distortion at 40 Hz is about 8%. With normal positioning of the subwoofer along a baseboard, the drive level required to reach 96 dB at that frequency would be much less than that used for this example, resulting in even less distortion.

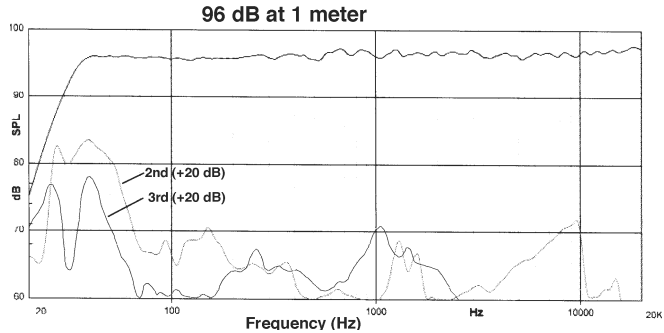

Figure 26. Distortion at 96 dB SPL at 1 meter for LSR6312SP.

### BIBLIOGRAPHY:

1. Button, D., "Magnetic Circuit Design Methodologies for Dual Coil Transducers," presented at the 103rd AES Convention, New York, September 1997
2. Eargle, J., & Foreman, C., *Audio Engineering for Sound Reinforcement*, Hal Leonard (Milwaukee, 2002)
3. JBL Technical Note, Volume 1, Number 33, JBL Differential Drive® Transducers
4. Linkwitz, S., "Active Crossover Network for Noncoincident Drivers, *Journal, AES*, vol. 24, no. 1 (1976)
5. Toole, F., "Loudspeaker Measurements and Their Relationship to Listener Preferences, parts 1 and 2" *Journal, AES*, vol. 34, nos. 4 and 5 (1986)



JBL Professional  
8500 Balboa Boulevard  
Northridge, California 91329 U.S.A.

A Harman International Company

© Copyright 2004 JBL Professional

TN VOL 3 NO 2A  
CRP ???M  
08/04